

INSTRUCTION MANUAL

BK PRECISION®

DIGITAL CLAMP METERS

MODELS 330B, 340B, 350B, 369B, 367A

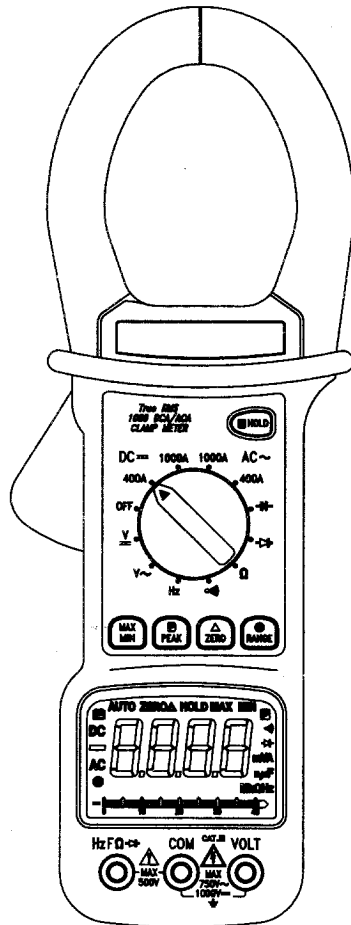

CE

CONTENTS

SAFETY	1
INTRODUCTION	2
SPECIFICATIONS	3 - 10
DC Current [367A], [369B]	3
AC Current [367A], [369B]	3
AC Current [350B], [340B], [330B]	4
DC Voltage [367A], [369B], [350B], [340B], [330B]	5
AC Voltage [367A], [369B], [350B], [340B], [330B]	6
Resistance [367A], [369B], [350B], [340B], [330B]	7
Continuity	8
Diode Test	8
Frequency [367A], [369B], [350B]	8
Frequency [340B]	9
Capacitance [367A], [369B], [340B]	9
General	10
SYMBOLS	11
CONTROLS & INDICATORS	12 - 14
OPERATING INSTRUCTIONS	15 - 25
Operating Tips	15
Auto Power Off	16
Manual Ranging	16
Data Hold	17
Max/Min Hold [367A], [369B]	17 - 18
Max Hold [340B, 330B]	18
Peak Hold [367A], [369B, 350B]	19
Relative Mode [367A], [369B]	20
AC Current Measurements	21
DC Current Measurements [367A], [369B]	21
Voltage Measurements	22
Resistance/Continuity Measurements	23
Diode Tests [367A, 369B, 350B, 340B]	24
Frequency Measurements [367A, 369B, 350B, 340B]	25
Capacitance Measurements [367A, 369B, 340B]	25
MAINTENANCE (Battery Replacement)	26
CUSTOMER SUPPORT	27
WARRANTY	29

SAFETY

WARNING

An electrical shock causing 10 milliamps of current to pass through the heart will stop most human heartbeats. Voltage as low as 35 volts dc or ac rms should be considered dangerous and hazardous since it can produce a lethal current under certain conditions. Higher voltages are even more dangerous. Observe the following safety precautions:

1. Never exceed the following input ratings to avoid the possibility of personal injury and/or damage to the instrument:
DC VOLTS 1000V DC
AC VOLTS 750V rms
AMPS 1000A DC or AC rms
OHMS, FREQ., CAP., DIODE TEST 500V DC or AC rms
2. Before using clamp meter, verify that battery compartment of the case is closed. Never use it with this compartment open.
3. Before taking measurements, inspect the meter, test leads and any accessories to make sure they are in good condition. Replace any defective items. Only use safety type test leads.
4. When using a probe, touch only the insulated portion. Never touch the exposed tip.
5. For your safety when making high voltage measurements while the power is on, never touch the equipment, meter, or test leads.
6. Insulation rating of the clamp is 500V. Do not clamp around conductors at higher voltages.
7. Use the time proven "one hand in the pocket" technique while handling an instrument probe. Be very careful to avoid contacting a nearby metal object that could provide a good ground return path. Never ground yourself when taking a measurement.
8. If possible, familiarize yourself with the equipment being tested and the location of its high voltage points. Remember that high voltage may appear at unexpected points in defective equipment.
9. Never try to service this meter unless you have been properly trained. Service must only be carried out by qualified and trained technicians.
10. Before replacing batteries, make sure that the input leads are disconnected from any voltage points and removed from the meter.
11. Never work alone. Someone should be nearby to render aid if necessary. Training CPR (cardio-pulmonary resuscitation) first aid is highly recommended.

INTRODUCTION

The 330B/340B/350B/367A/369B family of rugged digital clamp meters will perform electrical measurements in the most severe industrial applications for many years. Non-intrusive current measurements are made without interrupting the circuit, just clamp the jaws around the conductor. The large 2.2 inch jaw opening accommodates large conductors; all models have a standard measurement capacity of 1,000 amps. These instruments also offer complete multimeter functions. All models in this series have the following minimum capabilities:

- AC current measurements to 1,000 amps
- AC voltage measurements to 750 volts
- DC voltage measurements to 1,000 volts
- Resistance measurements
- Continuity measurements
- Compliance with tough IEC-1010 safety standards

MODEL 330B. Model 330B is the most economical clamp meter of the series. It includes all features needed for basic electrical testing. This model features a 3-1/2 digit (2000 count) LCD display and manual ranging. It offers a total of 9 measurement ranges. Although economical, it includes a useful MAX hold to retain the highest of varying readings.

MODEL 340B. Model 340B is a more versatile manual ranging AC clamp meter. It features a 3-1/2 digit (2000 count) LCD display and MAX hold like Model 330B. However, it has a greater number of voltage, current and resistance ranges. Furthermore, it adds diode test, frequency measurement and capacitance measurement. The total number of measurement ranges is 19.

MODEL 350B. Model 350B is a more deluxe AC clamp meter with a 3200 count LCD display with an analog bargraph and autoranging. Peak hold is included for current, voltage, frequency and resistance measurements. The total measurement ranges is expanded to 23.

MODEL 367A, 369B. Model 367A, 369B is the most deluxe instrument of the series and offers several features that are vital in some applications. Model 367A, 369B is an AC/DC clamp meter; that is, it measures both AC and DC currents to 1,000 amps. AC measurements, both voltage and current, are true RMS. Other deluxe features include a 4000 count LCD with analog bargraph, autoranging, Relative Mode, MIN/MAX recording and Peak Hold for current measurements. Model 367A, 369B boasts a total of 33 measurement ranges.

SPECIFICATIONS

ELECTRICAL

NOTE: Accuracy is given as \pm (% of reading + number of least significant digits) at 18°C to 28°C, with relative humidity up to 70%.

** Accuracy stated with conductor centered in jaws. Add 1% if conductor is not centered in jaws.

DC Current [367A] (Using clamp): ** Manual Ranging

Range	Resolution	Accuracy
400 A	100 mA	0-600 A, \pm (1.5% reading + 5 digits)
2000 A	1 A	600-800 A, \pm (2.0% reading + 5 digits) 800-1200 A, \pm (3.5% reading + 5 digits) 1200-2000 A, \pm (5.0% reading + 5 digits)

Overload Protection: 2000A for 60 seconds maximum.

AC Current [367A] (Using clamp): ** True rms, Manual Ranging

Range	Resolution	Accuracy at 50/60 Hz
400 A	100 mA	0-600 A, \pm (1.5% reading + 5 digits)
2000 A	1 A	600-1000 A, \pm (2.0% reading + 5 digits) 1000-1500 A, \pm (5.0% reading + 5 digits) 1500-1800 A, \pm (6.0% reading + 5 digits) 1800-2000 A, \pm (8.5% reading + 5 digits)
		Accuracy at 60-400 Hz
		0-600 A, \pm (3.0% reading + 5 digits) 600-1000 A, \pm (3.5% reading + 5 digits) 1000-1500 A, \pm (5.0% reading + 5 digits)

Crest Factor: ≥ 3 .

Overload Protection: 2000 A for 60 seconds maximum.

DC Current [369B] (Using clamp): ** Manual Ranging

Range	Resolution	Accuracy
400 A	100 mA	0-600 A, \pm (1.5% reading + 5 digits)
1000 A	1 A	600-800 A, \pm (2.5% reading + 5 digits) >800 A, \pm (3.5% reading + 5 digits)

Overload Protection: 1200A for 60 seconds maximum.

AC Current [369B] (Using clamp): ** True rms, Manual Ranging

Range	Resolution	Accuracy at 50/60 Hz
400 A	100 mA	0-600 A, \pm (1.5% reading + 5 digits)
1000 A	1 A	>600 A, \pm (2.0% reading + 5 digits)
		Accuracy at 60-400 Hz
		0-600 A, \pm (3.0% reading + 5 digits) >600 A, \pm (3.5% reading + 5 digits)

Crest Factor: ≥ 3

Overload Protection: 1200 A for 60 seconds maximum.

SPECIFICATIONS

AC Current [350B] (Using clamp): ** Average sensing, rms reading, Manual Ranging

Range	Resolution	Accuracy at 50/60 Hz
32 A	10 mA	0-600 A, $\pm(1.5\%$ reading + 5 digits)
320 A	100 mA	>600 A, $\pm(2\%$ reading + 5 digits)
1000 A	1 A	Accuracy at 60-400 Hz 0-600 A, $\pm(3\%$ reading + 5 digits) >600 A, $\pm(3.5\%$ reading + 5 digits)

Overload Protection: 1200 A for 60 seconds maximum.

AC Current [340B] (Using clamp): ** Average sensing, rms reading, Manual Ranging

Range	Resolution	Accuracy at 50/60 Hz
20 A	10 mA	<20 A, $\pm(2.5\%$ reading + 5 digits)
200 A	100 mA	20-600 A, $\pm(1.5\%$ reading + 5 digits)
1000 A	1 A	>600 A, $\pm(2.0\%$ reading + 5 digits) Accuracy at 60-400 Hz <20 A, $\pm(3.5\%$ reading + 5 digits) 20-600 A, $\pm(3\%$ reading + 5 digits) >600 A, $\pm(3.5\%$ reading + 5 digits)

Overload Protection: 1200 A for 60 seconds maximum.

AC Current [330B] (Using clamp): ** Average sensing, rms reading, Manual Ranging

Range	Resolution	Accuracy at 50/60 Hz
200 A	100 mA	<600 A, $\pm(1.5\%$ reading + 5 digits)
1000 A	1 A	>600 A, $\pm(2.0\%$ reading + 5 digits) Accuracy at 60-400 Hz <600 A, $\pm(3.0\%$ reading + 5 digits) >600 A, $\pm(3.5\%$ reading + 5 digits)

Overload Protection: 1200 A for 60 seconds maximum.

SPECIFICATIONS

DC Voltage [367A, 369B] (Using Test Leads): Auto or Manual Ranging

Range	Resolution	Accuracy	Input Impedance
400 mV	100 μ V	$\pm(0.5\%$ reading + 1 digit)	>1000 M Ω
4 V	1 mV	$\pm(0.5\%$ reading + 1 digit)	11 M Ω
40 V	10 mV	$\pm(0.5\%$ reading + 1 digit)	10 M Ω
400 V	100 mV	$\pm(0.5\%$ reading + 1 digit)	10 M Ω
1000 V	1 V	$\pm(0.5\%$ reading + 1 digit)	10 M Ω

Overload Protection: 1000 V dc or 750 V ac rms.

DC Voltage [350B] (Using Test Leads): Auto or Manual Ranging

Range	Resolution	Accuracy	Input Impedance
320 mV	100 μ V	$\pm(0.5\%$ reading + 1 digit)	>1000 M Ω
3.2 V	1 mV	$\pm(0.5\%$ reading + 1 digit)	11 M Ω
32 V	10 mV	$\pm(0.5\%$ reading + 1 digit)	10 M Ω
320 V	100 mV	$\pm(0.5\%$ reading + 1 digit)	10 M Ω
1000 V	1 V	$\pm(0.5\%$ reading + 1 digit)	10 M Ω

Overload Protection: 1000 V dc or 750 V ac rms.

DC Voltage [340B] (Using Test Leads): Manual Ranging

Range	Resolution	Accuracy	Input Impedance
200 mV	100 μ V	$\pm(0.5\%$ reading + 1 digit)	10 M Ω
20 V	10 mV	$\pm(0.5\%$ reading + 1 digit)	10 M Ω
1000 V	1 V	$\pm(0.5\%$ reading + 1 digit)	10 M Ω

Overload Protection: 200 mV range, 500 V dc or 350 V rms. All other ranges, 1000 V dc or 750 V ac rms.

DC Voltage [330B] (Using Test Leads): Manual Ranging

Range	Resolution	Accuracy	Input Impedance
1000 V	1 V	$\pm(0.5\%$ reading + 1 digit)	10 M Ω

Overload Protection: 1000 V dc or 750 V ac rms.

SPECIFICATIONS

AC Voltage [367A, 369B] (Using Test Leads): True rms. Auto or Manual Ranging

Range	Resolution	Accuracy, 50 to 500 Hz	Input Impedance
*400 mV	100 μ V	$\pm(1.5\%$ reading + 4 digits)	>1000 M Ω / <100 pF
4 V	1 mV	$\pm(1.5\%$ reading + 4 digits)	11 M Ω / <100 pF
40 V	10 mV	$\pm(1.5\%$ reading + 4 digits)	10 M Ω / <100 pF
400 V	100 mV	$\pm(1.5\%$ reading + 4 digits)	10 M Ω / <100 pF
750 V	1 V	$\pm(1.5\%$ reading + 4 digits)	10 M Ω / <100 pF

* Input signal, >40 mV; frequency, 50-100 Hz.

Crest Factor: ≥ 3 .

Overload Protection: 1000 V dc or 750 V ac rms.

AC Voltage [350B] (Using Test Leads): Average sensing, rms reading, Auto or Manual Ranging

Range	Resolution	Accuracy, 50 to 300 Hz	Input Impedance
3.2 V	1 mV	$\pm(1.5\%$ reading + 4 digits)	11 M Ω / <20 pF
32 V	10 mV	$\pm(1.5\%$ reading + 4 digits)	10 M Ω / <20 pF
320 V	100 mV	$\pm(1.5\%$ reading + 4 digits)	10 M Ω / <20 pF
750 V	1 V	$\pm(1.5\%$ reading + 4 digits)	10 M Ω / <20 pF

Overload Protection: 1000 V dc or 750 V ac rms.

AC Voltage [340B] (Using Test Leads): Average sensing, rms reading, Manual Ranging

Range	Resolution	Accuracy, 50 to 500 Hz	Input Impedance
200 V	100 mV	$\pm(1.5\%$ reading + 4 digits)	4.5 M Ω
750 V	1 V	$\pm(1.5\%$ reading + 4 digits)	4.5 M Ω

Overload Protection: 1000 V dc or 750 V ac rms.

AC Voltage [330B] (Using Test Leads): Average sensing, rms reading, Manual Ranging

Range	Resolution	Accuracy, 50 to 500 Hz	Input Impedance
750 V	1 V	$\pm(1.5\%$ reading + 4 digits)	4.5 M Ω

Overload Protection: 1000 V dc or 750 V ac rms.

SPECIFICATIONS

Resistance [367A, 369B] (Using Test Leads): Auto or Manual Ranging

Range	Resolution	Accuracy	Open Circuit Volts
400 Ω	0.1 Ω	$\pm(1.2\%$ reading + 4 digits)	0.4 V dc
4 k Ω	1 Ω	$\pm(1.0\%$ reading + 2 digits)	0.4 V dc
40 k Ω	10 Ω	$\pm(1.0\%$ reading + 2 digits)	0.4 V dc
400 k Ω	100 Ω	$\pm(1.0\%$ reading + 2 digits)	0.4 V dc
4000 k Ω	1 k Ω	$\pm(1.5\%$ reading + 4 digits)	0.4 V dc
40 M Ω	10 k Ω	$\pm(2.0\%$ reading + 4 digits)	0.4 V dc

Overload Protection: 500 V dc or ac rms.

Resistance [350B] (Using Test Leads): Auto or Manual Ranging

Range	Resolution	Accuracy	Test Current
320 Ω	0.1 Ω	$\pm(1.0\%$ reading + 3 digits)	<0.7 mA
3.2 k Ω	1 Ω	$\pm(1.0\%$ reading + 3 digits)	<0.13 mA
32 k Ω	10 Ω	$\pm(1.0\%$ reading + 3 digits)	<13 μ A
320 k Ω	100 Ω	$\pm(1.0\%$ reading + 3 digits)	<1.3 μ A
3.2 M Ω	1 k Ω	$\pm(1.5\%$ reading + 3 digits)	<0.13 μ A
30 M Ω	10 k Ω	$\pm(2.5\%$ reading + 5 digits)	<0.13 μ A

Overload Protection: 500 V dc or ac rms.

Resistance [340B] (Using Test Leads): Manual Ranging

Range	Resolution	Accuracy	Open Circuit Volts
200 Ω	0.1 Ω	$\pm(1.2\%$ reading + 4 digits)	3.0 V dc
2 k Ω	1 Ω	$\pm(1.0\%$ reading + 3 digits)	0.3 V dc
20 k Ω	10 Ω	$\pm(1.0\%$ reading + 3 digits)	0.3 V dc
200 k Ω	100 Ω	$\pm(1.0\%$ reading + 3 digits)	0.3 V dc
2 M Ω	1 k Ω	$\pm(1.0\%$ reading + 3 digits)	0.3 V dc
20 M Ω	10 k Ω	$\pm(2.0\%$ reading + 5 digits)	0.3 V dc

Overload Protection: 1000 V dc or 750 V ac rms.

Resistance [330B] (Using Test Leads): Manual Ranging

Range	Resolution	Accuracy	Open Circuit Volts
200 Ω	0.1 Ω	$\pm(1.2\%$ reading + 4 digits)	3.0 V dc
2 k Ω	1 Ω	$\pm(1.0\%$ reading + 3 digits)	0.3 V dc
20 M Ω	10 k Ω	$\pm(2.0\%$ reading + 5 digits)	0.3 V dc
2000 M Ω	100 k Ω	$\pm[(5\%$ reading - 10 digits) + 10 digits]	3.0 V dc

Overload Protection: 1000 V dc or 750 V ac rms.

SPECIFICATIONS

Continuity Test (Using Test Leads):

Model	Range	Audible Threshold	Response Time	Test Current
367A	400 Ω	< 40 Ω	About 500 ms	< 0.4 mA
369B	400 Ω	< 40 Ω	About 500 ms	< 0.4 mA
350B	320 Ω	< 20 Ω	About 500 ms	< 0.7 mA
340B	2k Ω	< 75 Ω	About 100 ms	< 1.0 mA
330B	200 Ω	< 75 Ω	About 100 ms	< 1.0 mA

Overload Protection: 500 V dc or ac rms.

Diode Test (Using Test Leads):

Model	Range	Resol.	Accuracy	Test Current	Open Circuit V
367A	4 V	1 mV	$\pm(1\% \text{ rdg} + 2 \text{ dgts})$	About 0.6 mA	3.2 V dc
369B	4 V	1 mV	$\pm(1\% \text{ rdg} + 2 \text{ dgts})$	About 0.6 mA	3.2 V dc
350B	3.2 V	1 mV	$\pm(10\% \text{ rdg} + 2 \text{ dgts})$	About 0.6 mA	3.0 V dc
340B	2 V	1 mV	$\pm(1.5\% \text{ rdg} + 2 \text{ dgts})$	About 1 mA	3.0 V dc

Overload Protection: 500 V dc or ac rms.

Frequency [367A, 369B] (Using Test Leads): Auto or Manual Ranging

Range	Resolution	Accuracy	Trigger Level
100 Hz	0.01 Hz	$\pm(0.1\% \text{ reading} + 10 \text{ digits})$	2.5V rms
1 kHz	0.1 Hz	$\pm(0.1\% \text{ reading} + 4 \text{ digits})$	2.5V rms
10 kHz	1 Hz	$\pm(0.1\% \text{ reading} + 4 \text{ digits})$	2.5V rms
100 kHz	10 Hz	$\pm(0.1\% \text{ reading} + 8 \text{ digits})$	2.5V rms
400 kHz	100 Hz	$\pm(0.1\% \text{ reading} + 20 \text{ digits})$	2.5V rms

Overload Protection: 500 V dc or ac rms.

NOTE: Frequencies < 100 Hz and > 100 kHz, reading may tend to be unstable

Minimum Frequency: 1 Hz.

Frequency [350B] (Using Test Leads): Manual Ranging

Range	Resolution	Accuracy at 50/60 Hz
320 Hz	0.1 Hz	$\pm(1.0\% \text{ rdg} + 4 \text{ digits})$
3200 Hz	1 Hz	$\pm(1.0\% \text{ rdg} + 4 \text{ digits})$
32 kHz	10 Hz	$\pm(1.0\% \text{ rdg} + 4 \text{ digits})$

Trigger Level: 3.5V rms min. at > 20% and < 80% duty cycle

Effective Reading: More than 100 digits at pulse width of > 2 μ s

Overload Protection: 500 V dc or ac rms

SPECIFICATIONS

Frequency [340B] (Using Test Leads): Auto Ranging

Range	Resolution	Accuracy	Trigger Level
10 Hz-40 kHz	1 Hz/10 Hz	$\pm(0.5\% \text{ reading} + 3 \text{ digits})$	2 V rms

Minimum Pulse Width: > 7.5 μ s w/duty cycle > 30% and < 70%.

Overload Protection: 500 V dc or ac rms.

Capacitance [367A, 369B] (Using Test Leads): Auto or Manual Ranging

Range	Resolution	Accuracy
4 nF	0.001 nF	$\pm(1.5\% \text{ reading} + 40 \text{ digits})^{**}$
40 nF	0.01 nF	$\pm(1.5\% \text{ reading} + 4 \text{ digits})^{**}$
400 nF	0.1 nF	$\pm(1.5\% \text{ reading} + 4 \text{ digits})$
4 μ F	0.001 μ F	$\pm(1.5\% \text{ reading} + 4 \text{ digits})$
40 μ F	0.01 μ F	$\pm(1.5\% \text{ reading} + 4 \text{ digits})$ at < 20 μ F $\pm(5.0\% \text{ reading} + 4 \text{ digits})$ at > 20 μ F

** After zeroing in relative mode.

Overload Protection: 500 V dc or ac rms.

Capacitance [340B] (Using Test Leads): Auto Ranging

Range	Resolution	Accuracy	Test Frequency
200 μ F	100 nF	$\pm(3.5\% \text{ reading} + 5 \text{ digits})$	42 Hz













Overload Protection: 500 V dc or ac rms.

SPECIFICATIONS

GENERAL

Jaw Opening:	2.24" (57 mm).
Display [367A, 369B]:	3-3/4 digit liquid crystal display (LCD), max. reading or 4000 counts (9999 in Frequency) with 42 segment bargraph. Character ht., 17 mm.
Display [350B]:	3-1/2 digit liquid crystal display (LCD), max. reading of 3200 counts with 34 segment bargraph. Character ht., 17 mm.
Display [330B, 340B]:	3-3/4 digit liquid crystal display (LCD), max. reading of 1999 counts. Character ht., 21 mm.
Measuring Rate:	[367A, 369B, 350B] Nominal, 2/sec.; Cap. & Freq., 1/sec. [330B, 340B] Nominal, 2.5/sec.
Auto Power OFF:	If not used, turns meter off after: [367A, 369B] about 30 minutes. [350B] about 10 minutes. [330B, 340B] manual shut-off.
Polarity:	Automatic, " - " shown + assumed.
Overrange Indication:	OL shown, all digits blank.
Low Battery Indication:	 symbol shown at about 7.4 V, or less.
Power Requirement:	Single 9 V battery (NEDA 1604A).
Battery Life, Alkaline:	[367A, 369B] 100 hours typical. [350B] 200 hours typical. [330B, 340B] 300 hours typical.
Operating Temp.:	0°C to 50°C, < 70% relative humidity.
Storage Temp.:	-20°C to +60°C, < 80% relative humidity w/battery removed.
Temperature Coefficient:	0.1° • specified accuracy / °C (<18°C or >28°C)
Dimensions (HxWxD):	10.9" x 4" x 1.9" (277 x 102 x 49 mm).
Weight:	18.9 oz (540 g), includes battery.
Accessories Supplied:	Battery Carrying Case Test Leads Instruction Manual

SYMBOLS

	See instruction manual for further precautionary information.
	Danger, high voltage terminal
	Double insulation, class II
COM	Common input jack
VOLT	Voltage input jack
V	Volts
A	Amperes
DC 	DC Voltage
AC 	AC Voltage
Ω	Ohms
	Continuity
	Diode Test
Hz	Frequency
μF	Capacitance
MAX/MIN	Monitor MAXimum or MINimum level
	Monitor PEAK level
Δ ZERO	Record ZERO (difference)
	Manual ranging
	Monitor maximum level
	Hold (freeze) level
	Earth ground
	Low battery symbol
500 V	Maximum input rating of terminal with respect to COM
750 V	input terminal.
1000 V	
MAX.	

CONTROLS & INDICATORS

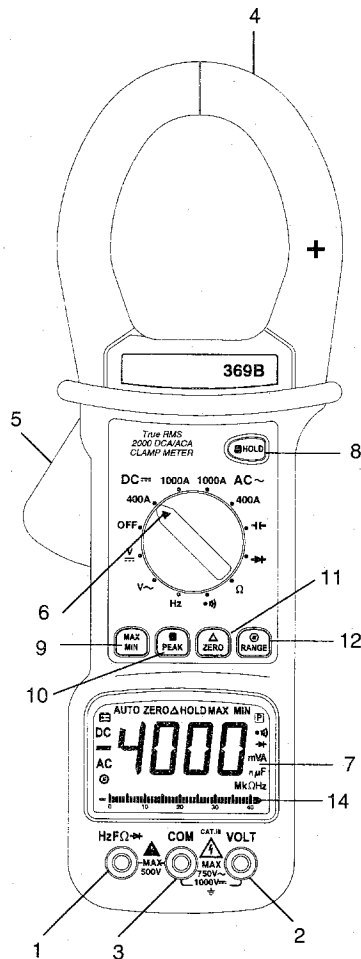
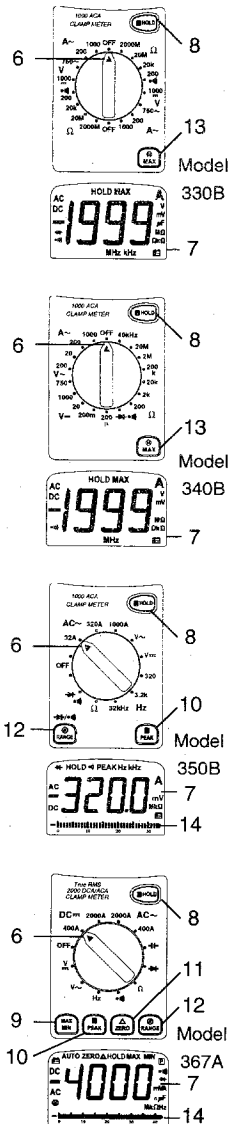

CONTROLS & INDICATORS

- **Hz Ω F Jack [367A, 369B, 340B]**. Test lead input for frequency, resistance, capacitance, continuity and diode test measurements.
 - **Hz Ω Jack [350B]**. Test lead input for frequency, resistance, continuity and diode test measurements.
 - **Ω Jack [330B]**. Test lead input for resistance and continuity measurements.
- VOLT Jack**. Positive (or high) test lead input for voltage measurements.
- COM Jack**. Black (common neutral, ground), low side test lead input.
- Current Clamp Jaws**. Use for current measurements without disconnecting circuit. Simply open jaws and loop around conductor.
- Lever**. Press to open, or release to close jaws.
- Power/Function/Range Selector**. Rotary switch to turn power off or to select measurement range and function.
- **Display, LCD Readout [367A, 369B, 350B]**. Indicates function selected, data reading selected (PEAK, HOLD, etc.) overrange, polarity (-), and low battery status. Digit display: 3¾ [367A, 369B], 3½ [350B], with automatic placement of decimal point. Maximum count: [367A, 369B] 4000; [350B] 3200.
 - **Display, LCD Readout [340B, 330B]**. Indicates function selected, data reading selected (MAX, HOLD) overrange, polarity (-), and low battery status. 3½ digit display (1999 maximum) with automatic placement of decimal.
- HOLD**. Press to freeze present reading at display and to display "HOLD" annunciator. Press again to exit.
- MAX/MIN [367A, 369B]**. Press to record and enable display of minimum and maximum input levels. Press this button to increment through levels recorded and present input level. Display shows HOLD MAX or MIN and active level.
- ▣ **PEAK [367A, 369B, 350B]**. Push button store peak value of a varying input, PEAK displayed. Press to toggle in and out.
 - ▲ **ZERO [367A, 369B]**. Push button to obtain difference between a stored reference and present reading, ▲ ZERO displayed. Stored reference is input level when ▲ ZERO data mode is enabled. Press and hold button down for at least 2 seconds to exit.

CONTROLS & INDICATORS

12. **Ⓢ RANGE [367A, 369B, 350B]**. Button to select manual range mode and to increment present range; **Ⓢ** shown at display. In this mode, each time button is pressed range increments by 0.1. Range starts from active autoranging level. To exit, press and hold down this button for about 2 seconds.
[367A, 369B] To override Auto Power Off, first set the Function switch to OFF, then press and hold the RANGE button while turning the Function switch to any "on" position, then release the RANGE button.
13. **Ⓜ MAX [340B, 330B]**. Button to capture and display the maximum value of a changing measurement. Press **Ⓜ** MAX again to exit.
14. **Bargraph**. Provides analog display of magnitude and direction of change of input; [369B] 42 segment, [350B] 32 segment.

OPERATING INSTRUCTIONS

OPERATING TIPS

Before using this meter review these tips carefully. They will help you to use it safely, get reliable measurements and avoid false readings.

1. Follow the instructions that apply to your specific model number. If an instruction applies only to a specific model or models, the model number is enclosed in brackets in the title or heading of the instruction.
2. Read, thoroughly understand and follow the SAFETY instructions given in this manual.
3. Examine your test leads. Make sure they are in good condition, free from cracks, etc., and that they make good contact with the jacks of your meter. Do this for safe operation and to avoid false readings.
4. Before taking a measurement, review the related instructions in this manual.
5. Before taking a measurement, estimate its expected value. If you are considerably out of an expected range, carefully review your circuit under test; it could be defective.
6. If value of measurement is unknown, start with the highest range.
7. Stay within the operating range of your meter. Never exceed the 750 V ac or 1000 V dc maximum limits and 500 V from **COM** jack to earth ground or reference.
8. If an overrange is shown, immediately switch to a higher range.

CAUTION

*Never switch between ranges while connected to high voltage.
This prevents damage to the instrument.*

9. When using the jaws to take a measurement, center a single conductor of a cable in the jaws and perpendicular to the jaws to avoid false readings. When two or more conductors are in the jaws when an ac reading is taken, current flows in each wire tend to cancel each other. Off center wires produce lower readings.
10. For reliable measurements, replace battery when the low battery symbol **Ⓛ** appears on display. See MAINTENANCE instructions to replace battery.
11. Set function selector to **OFF** when not in use to conserve battery power.

OPERATING INSTRUCTIONS

AUTO POWER OFF [367A, 369B, 350B]

Auto Power Off is a feature that conserves battery power when you forget to turn the power off. When the Function switch position has not been changed for about 30 minutes for Model 367A, 369B, or about 10 minutes for Model 350B, the meter automatically turns off. If you are using the meter to make several measurements without changing the position of the Function switch, the meter may turn off. To restart, simply rotate the Function switch at least one position.

MANUAL RANGING [367A, 369B, 350B]

Range selection of Models 330B and 340B is always done manually by the front panel rotary switch. Models 350B and 367A, 369B normally operate in the autoranging mode, but may be switched to manual ranging by the **RANGE** button.

This first press of the **RANGE** button switches the meter from autoranging to the manual ranging mode and the **RANGE** annunciator is displayed. The range does not change. With each additional press of the **RANGE** button, the meter steps to the next higher range until the highest range is reached, then it steps to lowest range.

When a range is exceeded, a series of "beeps" are emitted until the correct range is reached.

When any of the following modes are selected, the meter is automatically reverts to manual ranging. It may be necessary to preselect the correct range before making these measurements: **MAX/MIN**, **HOLD**, **PEAK HOLD** and Relative Mode.

To exit manual ranging mode and return to autoranging, hold the **RANGE** button down for about 2 seconds. The **RANGE** symbol will disappear from the display and the **AUTO** annunciator will reappear.

OPERATING INSTRUCTIONS

DATA HOLD

The Data Hold feature permits the displayed reading to be frozen. For example, when clamped around a conductor where light conditions are poor, press the **HOLD** button. The reading is frozen and can be read after unclamping the meter and bringing it into the light. While the Data Hold mode is enabled, the **HOLD** annunciator is displayed. Press the **HOLD** button a second time to exit this mode. The **HOLD** annunciator disappears from the display.

MAX/MIN HOLD [367A, 369B]

The **MAX/MIN HOLD** feature permits recording the lowest and highest value of a changing measurement.

The first press of the **MAX/MIN** button enables the **MAX/MIN** Record mode. The highest and lowest values measured since entering this mode are recorded and stored in memory. **MAX** or **MIN** or present values can be reviewed by successive presses of the **MAX/MIN** button. When **MIN** and **HOLD** are displayed, the reading shown is the "lowest" since entering this mode. When **MAX** and **HOLD** are displayed, the reading shown is the "highest" since entering this mode. When neither **MAX** nor **MIN** nor **HOLD** are displayed, but the manual ranging symbol (**RANGE**) remains, the present value is displayed and recording continues.

Auto Power Off is overridden in the **MAX/MIN** Record mode so that recording may be extended for many hours if desired.

To use the **MAX/MIN** Record mode properly, first connect the test leads to the point of measurement and then wait for the reading to stabilize. After it stabilizes, press the **MAX/MIN** button. If the button is pressed before the test leads are connected, the **MIN** reading will be zero. Also, the meter reverts to manual range operation upon entering the **MAX/MIN** Record mode. If the test leads are not yet connected, the meter will remain in the lowest range and may overrange when connected. If the variation swing of the value is great, it may be necessary to manually step to a higher range to prevent an overrange condition on the **MAX** value.

To exit the **MAX/MIN** Record mode, hold the **MAX/MIN** button down for about 2 seconds.

OPERATING INSTRUCTIONS

MAX/MIN HOLD [367A, 369B] (cont.)

The MAX/MIN Record mode operates at the speed of the display update, about 2 times per second. That is, it records the **MAX** or **MIN** reading of the display. The speed of acquisition in this mode differs (slower) from the PEAK HOLD operation.

The following illustration shows the displays when the DC Amperes function was selected with MIN of 10 A, MAX of 15.2 A and a present value of 12.03 A.

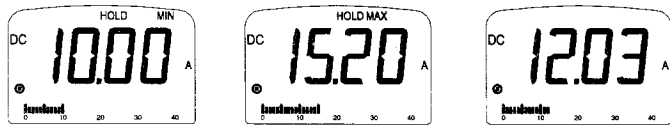

(1) MIN Active

(2) Increment to MAX

(3) Increment to Present

MAX HOLD [340B, 330B]

The operation of the MAX HOLD feature is similar to MAX/MIN Hold except that it records only the "highest value". Press the **MAX** button once to enable the MAX Hold mode. When enabled, **MAX** is displayed and the reading is the highest value sensed since entering this mode. Press the **MAX** button a second time to exit this mode and return to normal operation.

OPERATING INSTRUCTIONS

PEAK HOLD [367A, 369B, 350B]

The PEAK HOLD feature allows measurement of a peak value, for example, the starting current of a motor. Model 367A, 369B enables the use of this feature only for ac current measurements. However, Model 350B enables the use of this feature for ac current, ac voltage, dc voltage, frequency and resistance measurements.

To measure peak current, clamp the meter jaws around the conductor and place the meter in a PEAK HOLD mode before starting the current. When using Model 367A, 369B, select AC current, meter reverts to manual ranging, then press the **PEAK** button twice so the **HOLD PEAK** annunciator is displayed along with manual range. When using Model 350B, select AC current, next press **PEAK**, **PEAK** should be displayed. Now manually, select a range high enough for the measurement, but remember, peak current may be much higher than the normal current. Next, apply power to the circuit under test; the peak value will be displayed and held for several seconds. The reading may then slowly begin to decay.

When measuring ac or dc voltage, frequency and resistance peak values with the Model 350B meter, test leads are used. The general operation is similar to the description given for measuring current. When measuring ac or dc voltage and frequency, just as when measuring current, the meter is connected to the source being measured before power is applied. The remaining operation follows the description outlined for ac current. Peak resistance measurements must be made with the power off.

Since test leads are now used, we recommend that you fit alligator clips onto these leads so they can be clipped onto the measuring points. Color coded alligator clips that mate with your test leads are available from **BK Precision**. These clips will allow you get reliable and safe measurements.



PEAK HOLD operates very fast, in a few milliseconds, long before it's shown at the display. Exit the PEAK HOLD mode by holding the **PEAK** button down for about 2 seconds.

OPERATING INSTRUCTIONS

RELATIVE MODE [367A, 369B]



REFERENCE READING

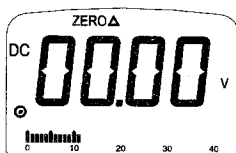

ZERO MODE ENTERED



DIFFERENCE

Relative mode (**Δ ZERO**) permits measurements with respect to a reference other than zero. First, measure a value for use as your reference, then press the **Δ ZERO** button. **ZERO Δ** is now displayed and the meter reverts to manual ranging. The reference value now becomes zero. All subsequent measurements are "relative" to the reference value. For example, for a reference of 316 ohms, first measure a 316 ohm value. Upon entering the **Δ ZERO** mode, a value of 316 ohms becomes zero, 320 ohms is read as 4 and 310 ohms is read as -6. If the variation from the reference is too great, an overrange may occur signaled by beeps. When this happens, uprange the meter then reestablish **Δ ZERO** reference on the new range.

To exit the relative mode, hold the **Δ ZERO** button down for about 2 seconds.

OPERATING INSTRUCTIONS

AC CURRENT MEASUREMENTS

CAUTION

Never try to measure currents where the maximum voltage between any conductor and ground exceeds 500 V to avoid personal harm and/or damage to the meter.

1. Remove test leads from meter.
2. Set function selector to **A ~** for ac current measurements and choose range. If range is unknown, start with the highest range, 1000 A.
3. Press trigger on left side of meter to open jaws. Now, clamp around a single conductor so it's centered and perpendicular in the jaws as shown in following illustration. Release trigger to clamp jaws and make sure they are fully closed.

ANY ADDITIONAL WIRES RUN OUTSIDE JAWS.

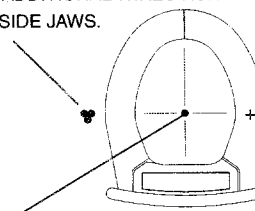

SINGLE CONDUCTOR CLAMPED, CENTERED AND PERPENDICULAR IN JAWS.

NOTE

Position jaws around only one conductor centered and perpendicular to jaws. If jaws are placed around two or more current carrying conductors reading will be false. For example, if clamped around the line cord of an ac appliance, currents flowing through the cord tend to cancel each other giving a false reading.

4. Read current level at display. If needed for better resolution, select a lower range.

DC CURRENT MEASUREMENTS [367A, 369B]

1. Set function selector to **A =** for dc current measurements and select range. If range is unknown, start with the highest range, 1000 A.
2. There may be a residual reading on the meter. Press the **Δ ZERO** button to zero the meter.
3. Clamp jaws around the conductor and read current level from display.
4. For maximum accuracy, remove the jaws from around the conductor and rezero the meter. Then repeat the measurement and use the second reading.

OPERATING INSTRUCTIONS

VOLTAGE MEASUREMENTS

Use these instructions for ac and dc measurements.

CAUTION

Never try to measure voltages greater than 750 V ac or 1000 V dc.

1. Select ac or dc voltage and range. If range is unknown, start with the highest range. Set function selector to V_{DC} for dc measurements or to V_{AC} for ac measurements.
2. Plug red test lead to VOLT jack, black test lead to COM jack.
3. Connect black test lead to common of circuit, red lead to point being measured at this circuit.
4. Value at display is actual level being measured, + assumed, - (negative) shown. Models 367A, 369B, 350B in AUTO mode only: Decimal point is correctly located for best resolution.
5. Models 330B, 340B, 367A, 369B, 350B in Manual ranging mode. Before changing range for better resolution, disconnect test leads from voltage source.

CAUTION

Never switch between ranges while connected to high voltage to avoid personal harm and/or damage to the meter.

6. Disconnect test leads from voltage source then switch meter to **OFF** to conserve power.

OPERATING INSTRUCTIONS

RESISTANCE/CONTINUITY MEASUREMENTS

CAUTION

Remove power from circuit under test before making resistance measurements.

1. Verify that power is off and that any capacitors are discharged in circuit about to be tested.
2. For resistance measurements:
 - [340B, 330B] Set function selector to Ω and select range. For best resolution, select range that closely matches actual resistance expected.
 - [367A, 369B, 350B] In AUTO (default) mode, set function selector to Ω . Range is automatically selected for best resolution. If meter is operating in manual ranging mode, select range that closely matches actual resistance expected.
3. For continuity measurements:
 - [367A, 369B, 330B] Set function selector to $\rightarrow \bullet$ position.
 - [350B, 340B] Set function selector to $\rightarrow \bullet$ position.
4. Plug black test lead into **COM** jack. Plug red test lead into following red jack as determined by model.
 - [367A, 369B, 340B] Plug red lead into **H Ω F** jack.
 - [350B] Plug red lead into **H Ω** jack.
 - [330B] Plug red lead into Ω jack.
5. Connect test leads across desired measuring points.
6. • Resistance measurements: Read resistance at display in ohms, kilohms, or megohms as shown by annunciator symbol.
 - Continuity measurements: Audible tone sounds when resistance is less than about:
 - [367A, 369B] 40 ohms.
 - [350B] 20 ohms.
 - [330B, 340B] 75 ohms.
7. Switch meter to **OFF** when readings are done to conserve battery power.

OPERATING INSTRUCTIONS

DIODE TESTS [367A, 369B, 350B, 340B]

CAUTION

Remove power from circuit under test before making diode measurements.

1. Verify that power is off and that any capacitors are discharged in circuit about to be tested.
2. • [367A, 369B] Set function selector to \rightarrow position.
• [350B, 340B] Set function selector to \rightarrow \bullet position.
• [350B] Press **RANGE** button so \rightarrow symbol is shown in display. Continuity \bullet is the default symbol.
3. Plug black test lead into **COM** jack. Plug red test lead into following red jack as determined by model.
• [367A, 369B, 340B] Plug red lead into **Hz Ω F \rightarrow** jack.
• [350B] Plug red lead into **Hz Ω \rightarrow** jack.
4. Connect black test lead to cathode of diode, red test lead to its anode. Typical forward voltages should be about as follows:
• Silicone diode: 0.7 V
• Germanium diode: 0.3 V
5. Reverse test leads, black to anode, red to cathode. Voltage reading should be as follows:
• [367A, 369B] 3.1 V
• [350B, 340B] OL should be shown.
6. Note: Make sure that correct reading is obtained in forward and reverse positions. If diode is partially shorted, the same or higher reading may be obtained in both positions. If diode is open, an overload OL may be shown in both positions.
7. Switch meter to **OFF** conserve power when tests are done.

OPERATING INSTRUCTIONS

FREQUENCY MEASUREMENTS [367A, 369B, 350B, 340B]

1. • [367A, 369B] Set function selector to **Hz** position. AUTO mode is on, range is automatically selected.
• [350B] Set function selector to Hz position and select range: **320 Hz, 3.2 kHz or 32 kHz**.
• [340B] Set function selector to **40 kHz** position.
2. Plug black test lead into **COM** jack. Plug red test lead into following red jack as determined by model.
• [367A, 369B, 340B] Plug red lead into **Hz Ω F \rightarrow** jack.
• [350B] Plug red lead into **Hz Ω \rightarrow** jack.
3. Connect test leads across desired measuring points. Make sure that peak of frequency signal does not exceed 500 V dc or ac.
4. Switch meter to **OFF** to conserve power.

CAPACITANCE MEASUREMENTS [367A, 369B, 340B]

CAUTION

Discharge capacitors before connecting to the meter. Capacitors should not be measured "in circuit". Parallel components will invalidate the measurement.

5. Verify that power is off and that any capacitors are discharged in circuit about to be tested. A capacitor can be safely discharged by connecting a 100 k resistor across its leads.
6. • [367A, 369B] Set function selector to \leftarrow position.
• [340B] Set function selector to 200 μ F position.
7. Plug black test lead into **COM** jack. Plug red lead into **Hz Ω F \rightarrow** jack.
8. Touch test leads to leads of capacitor. Be sure to observe polarity when testing polarized capacitors. Read capacity in microfarads at display.
9. Accuracy Note, 367A, 369B only: Measurement accuracy can be improved by first selecting the ZERO feature. Next, zero the display which automatically subtracts any residual capacitance in the meter and test leads. After zeroing, take your measurement. The new reading will be the true capacitance, residual capacitance subtracted from total capacitance.
10. Switch meter to **OFF** to conserve power.

MAINTENANCE

WARNING

Remove test leads before changing batteries. Never operate instrument with battery compartment open.

CAUTION

Remove discharged batteries immediately to prevent damage from battery leakage.

BATTERY REPLACEMENT

The low battery symbol on the display indicates that battery power under load has dropped to about 7.4 V. The meter may still be used for a short time afterwards; however, replace the battery as soon as possible.

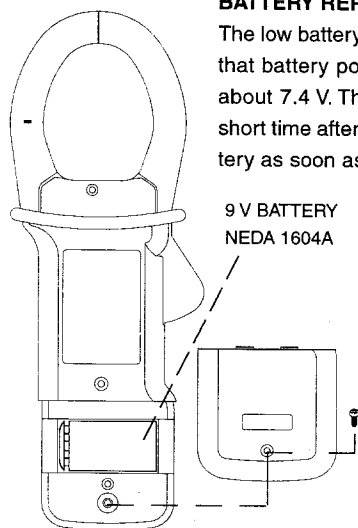

9 V BATTERY
NEDA 1604A

The battery compartment cover is located at the rear or the case - near bottom. To replace battery, remove Phillips screw in cover then remove cover. The meter uses a standard 9 V (NEDA 1604A) battery. After replacing battery, be sure to replace cover and tighten screw to secure the compartment.

REAR VIEW, COVER REMOVED

HELPFUL HINT, TEST LEADS

Only use the safety type test leads like those supplied with this meter for safe operation and to avoid false readings. Periodically inspect these test leads to ensure that the conductors are not intermittent, corroded or broken. Keep the jack area of the meter free of dirt. Inspect the test leads for breaks in the insulation and replace as necessary.

Replacement test leads are available from **BK Precision**, request Model TL-1.

SERVICE INFORMATION

Warranty Service: Please return the product in the original packaging with proof of purchase to the below address. Clearly state in writing the performance problem and return any leads, connectors and accessories that you are using with the device.

Non-Warranty Service: Return the product in the original packaging to the below address. Clearly state in writing the performance problem and return any leads, connectors and accessories that you are using with the device. Customers not on open account must include payment in the form of a money order or credit card. For the most current repair charges contact the factory before shipping the product.

Return all merchandise to B&K Precision Corp. with pre-paid shipping. The flat-rate repair charge includes return shipping to locations in North America. For overnight shipments and non-North American shipping fees contact B&K Precision Corp.

B&K Precision Corp.
1031 Segovia Circle
Placentia, CA 92870

Phone: 714-237-9220
Facsimile: 714-237-9214
Email: service@bkprecision.com

Include with the instrument your complete return shipping address, contact name, phone number and description of problem.