

**AOL1700**
**N-Channel Enhancement Mode Field Effect Transistor**
**SRFET™**
**General Description**

**SRFET™** AOL1700 uses advanced trench technology with a monolithically integrated Schottky diode to provide excellent  $R_{DS(ON)}$  and low gate charge. This device is suitable for use as a low side FET in SMPS, load switching and general purpose applications.

- RoHS Compliant
- Halogen and Antimony Free Green Device\*

**Features**

$V_{DS}$  (V) = 30V  
 $I_D$  =85A ( $V_{GS}$  = 10V)  
 $R_{DS(ON)} < 4.2m\Omega$  ( $V_{GS}$  = 10V)  
 $R_{DS(ON)} < 6.0m\Omega$  ( $V_{GS}$  = 4.5V)

UIS Tested!  
 Rg,Ciss,Coss,Crss Tested

Ultra SO-8™ Top View

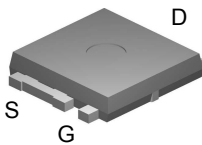

Bottom tab connected to drain

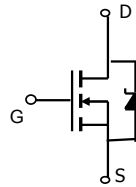

**SRFET™**  
 Soft Recovery MOSFET:  
 Integrated Schottky Diode

**Absolute Maximum Ratings  $T_A=25^\circ\text{C}$  unless otherwise noted**

| Parameter   | Symbol         | Maximum                             | Units            |
|---|----------------|-------------------------------------|------------------|
| Drain-Source Voltage                                      | $V_{DS}$       | 30                                  | V                |
| Gate-Source Voltage                                       | $V_{GS}$       | $\pm 20$                            | V                |
| Continuous Drain Current <sup>B</sup>                     | $I_D$          | $T_C=25^\circ\text{C}$ <sup>H</sup> | 85               |
|   |                | $T_C=100^\circ\text{C}$             | 81               |
| Pulsed Drain Current <sup>C</sup>                         | $I_{DM}$       | 200                                 | A                |
| Continuous Drain Current <sup>A</sup>                     | $I_{DSM}$      | $T_A=25^\circ\text{C}$              | 17               |
|   |                | $T_A=70^\circ\text{C}$              | 13               |
| Avalanche Current <sup>C</sup>                            | $I_{AR}$       | 30                                  | A                |
| Repetitive avalanche energy $L=0.3\text{mH}$ <sup>C</sup> | $E_{AR}$       | 135                                 | mJ               |
| Power Dissipation <sup>B</sup>                            | $P_D$          | $T_C=25^\circ\text{C}$              | 100              |
|   |                | $T_C=100^\circ\text{C}$             | 50               |
| Power Dissipation <sup>A</sup>                            | $P_{DSM}$      | $T_A=25^\circ\text{C}$              | 2.1              |
|   |                | $T_A=70^\circ\text{C}$              | 1.3              |
| Junction and Storage Temperature Range                    | $T_J, T_{STG}$ | -55 to 175                          | $^\circ\text{C}$ |

**Thermal Characteristics**

| Parameter                                | Symbol          | Typ                 | Max  | Units              |
|--|-----------------|---------------------|------|--------------------|
| Maximum Junction-to-Ambient <sup>A</sup> | $R_{\theta JA}$ | $t \leq 10\text{s}$ | 19.6 | $^\circ\text{C/W}$ |
| Maximum Junction-to-Ambient <sup>A</sup> |                 | Steady-State        | 50   | $^\circ\text{C/W}$ |
| Maximum Junction-to-Case <sup>D</sup>    | $R_{\theta JC}$ | 1                   | 1.5  | $^\circ\text{C/W}$ |

Electrical Characteristics (T<sub>J</sub>=25°C unless otherwise noted)

| Symbol                      | Parameter   | Conditions   | Min | Typ        | Max        | Units |
|-----------------------------|---|--|-----|------------|------------|-------|
| <b>STATIC PARAMETERS</b>    |   |  |     |            |            |       |
| BV <sub>DSS</sub>           | Drain-Source Breakdown Voltage                                      | I <sub>D</sub> =1mA, V <sub>GS</sub> =0V   | 30  |            |            | V     |
| I <sub>DSS</sub>            | Zero Gate Voltage Drain Current                                     | V <sub>DS</sub> =30V, V <sub>GS</sub> =0V<br>T <sub>J</sub> =125°C                         |     |            | 0.1<br>20  | mA    |
| I <sub>GSS</sub>            | Gate-Body leakage current   | V <sub>DS</sub> =0V, V <sub>GS</sub> = ±20V  |     |            | 0.1        | μA    |
| V <sub>GS(th)</sub>         | Gate Threshold Voltage  | V <sub>DS</sub> =V <sub>GS</sub> I <sub>D</sub> =250μA                                     | 1.2 | 1.5        | 2.2        | V     |
| I <sub>D(ON)</sub>          | On state drain current  | V <sub>GS</sub> =10V, V <sub>DS</sub> =5V  | 200 |            |            | A     |
| R <sub>DS(ON)</sub>         | Static Drain-Source On-Resistance                                   | V <sub>GS</sub> =10V, I <sub>D</sub> =20A<br>T <sub>J</sub> =125°C                         |     | 3.4<br>5.2 | 4.2<br>6.5 | mΩ    |
|                             |   | V <sub>GS</sub> =4.5V, I <sub>D</sub> =20A   |     | 4.8        | 6.0        | mΩ    |
| g <sub>FS</sub>             | Forward Transconductance  | V <sub>DS</sub> =5V, I <sub>D</sub> =20A   |     | 90         |            | S     |
| V <sub>SD</sub>             | Diode Forward Voltage   | I <sub>S</sub> =1A, V <sub>GS</sub> =0V  |     | 0.36       | 0.5        | V     |
| I <sub>S</sub>              | Maximum Body-Diode + Schottky Diode Continuous Current <sup>H</sup> |  |     |            | 85         | A     |
| <b>DYNAMIC PARAMETERS</b>   |   |  |     |            |            |       |
| C <sub>iss</sub>            | Input Capacitance   | V <sub>GS</sub> =0V, V <sub>DS</sub> =15V, f=1MHz  |     | 3760       | 4512       | pF    |
| C <sub>oss</sub>            | Output Capacitance  |  |     | 682        |            | pF    |
| C <sub>rss</sub>            | Reverse Transfer Capacitance  |  |     | 314        |            | pF    |
| R <sub>g</sub>              | Gate resistance   | V <sub>GS</sub> =0V, V <sub>DS</sub> =0V, f=1MHz   |     | 0.75       | 1.5        | Ω     |
| <b>SWITCHING PARAMETERS</b> |   |  |     |            |            |       |
| Q <sub>g</sub> (10V)        | Total Gate Charge   | V <sub>GS</sub> =10V, V <sub>DS</sub> =15V, I <sub>D</sub> =20A                            |     | 62         | 74         | nC    |
| Q <sub>g</sub> (4.5V)       | Total Gate Charge   |  |     | 29         | 35         | nC    |
| Q <sub>gs</sub>             | Gate Source Charge  |  |     | 12         |            | nC    |
| Q <sub>gd</sub>             | Gate Drain Charge   |  |     | 12         |            | nC    |
| t <sub>D(on)</sub>          | Turn-On DelayTime   | V <sub>GS</sub> =10V, V <sub>DS</sub> =15V, R <sub>L</sub> =0.75Ω,<br>R <sub>GEN</sub> =3Ω |     | 9.5        |            | ns    |
| t <sub>r</sub>              | Turn-On Rise Time   |  |     | 8.5        |            | ns    |
| t <sub>D(off)</sub>         | Turn-Off DelayTime  |  |     | 34         |            | ns    |
| t <sub>f</sub>              | Turn-Off Fall Time  |  |     | 9          |            | ns    |
| t <sub>rr</sub>             | Body Diode Reverse Recovery Time                                    | I <sub>F</sub> =20A, di/dt=300A/μs   |     | 18         | 27         | ns    |
| Q <sub>rr</sub>             | Body Diode Reverse Recovery Charge                                  | I <sub>F</sub> =20A, di/dt=300A/μs   |     | 22         |            | nC    |

A: The value of R<sub>θJA</sub> is measured with the device in a still air environment with T<sub>A</sub>=25°C. The power dissipation P<sub>DSM</sub> and current rating I<sub>DISM</sub> are based on T<sub>J(MAX)</sub>=150°C, using steady-state junction-to-ambient thermal resistance.

B: The power dissipation P<sub>D</sub> is based on T<sub>J(MAX)</sub>=175°C, using junction-to-case thermal resistance, and is more useful in setting the upper dissipation limit for cases where additional heatsinking is used.

C: Repetitive rating, pulse width limited by junction temperature T<sub>J(MAX)</sub>=175°C.

D: The R<sub>θJA</sub> is the sum of the thermal impedance from junction to case R<sub>θJC</sub> and case to ambient.

E: The static characteristics in Figures 1 to 6 are obtained using <300 us pulses, duty cycle 0.5% max.

F: These curves are based on the junction-to-case thermal impedance which is measured with the device mounted to a large heatsink, assuming a maximum junction temperature of T<sub>J(MAX)</sub>=175°C. The SOA curve provides a single pulse rating.

G: These tests are performed with the device mounted on 1 in 2 FR-4 board with 2oz. Copper, in a still air environment with T<sub>A</sub>=25°C.

H: The maximum current rating is limited by bond-wires.

\* This device is guaranteed green after date code 8P11 (June 1<sup>ST</sup> 2008)

Rev3: Dec 2008

THIS PRODUCT HAS BEEN DESIGNED AND QUALIFIED FOR THE CONSUMER MARKET. APPLICATIONS OR USES AS CRITICAL COMPONENTS IN LIFE SUPPORT DEVICES OR SYSTEMS ARE NOT AUTHORIZED. AOS DOES NOT ASSUME ANY LIABILITY ARISING OUT OF SUCH APPLICATIONS OR USES OF ITS PRODUCTS. AOS RESERVES THE RIGHT TO IMPROVE PRODUCT DESIGN, FUNCTIONS AND RELIABILITY WITHOUT NOTICE.

TYPICAL ELECTRICAL AND THERMAL CHARACTERISTICS

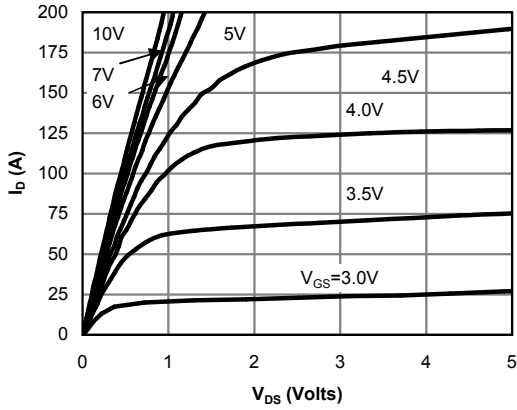

Figure 1: On-Region Characteristics

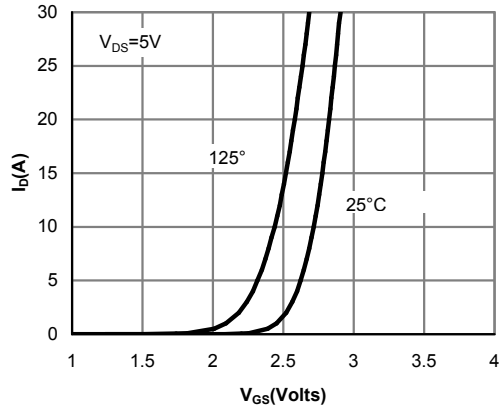

Figure 2: Transfer Characteristics

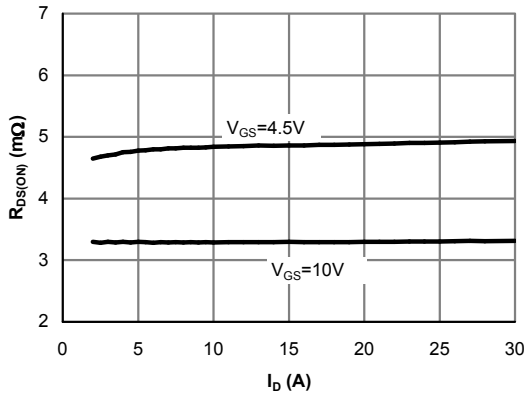

Figure 3: On-Resistance vs. Drain Current and Gate Voltage

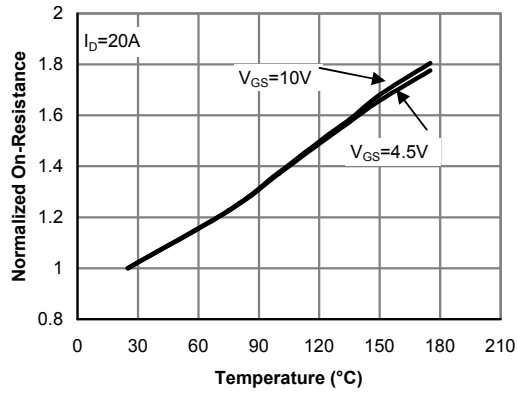

Figure 4: On-Resistance vs. Junction Temperature

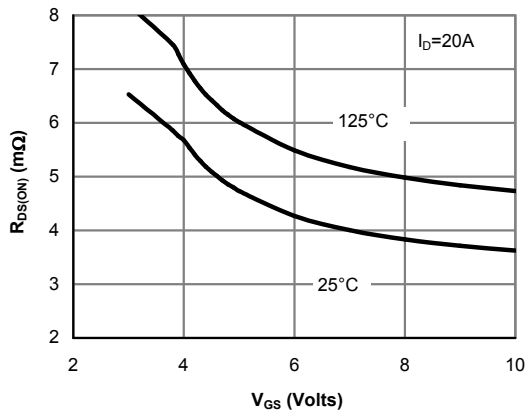

Figure 5: On-Resistance vs. Gate-Source Voltage

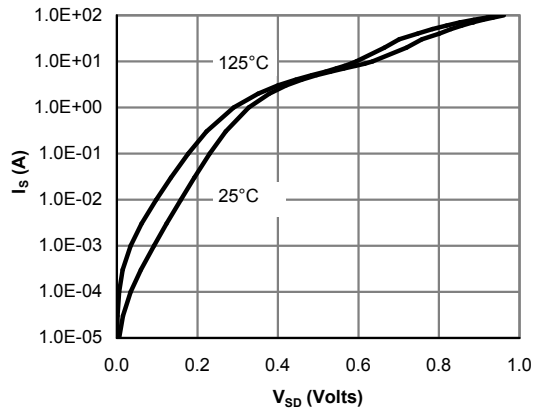

Figure 6: Body-Diode Characteristics

TYPICAL ELECTRICAL AND THERMAL CHARACTERISTICS

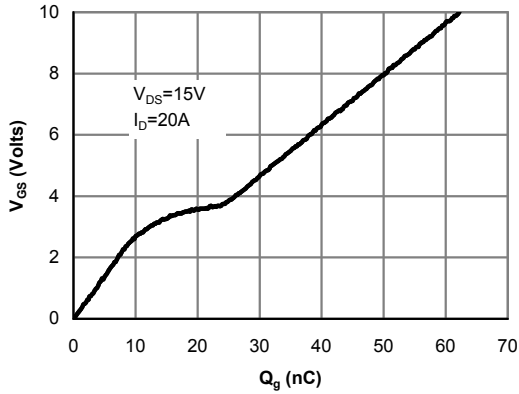

Figure 7: Gate-Charge Characteristics

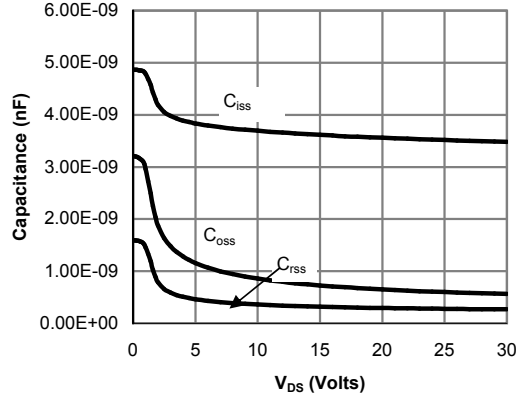

Figure 8: Capacitance Characteristics

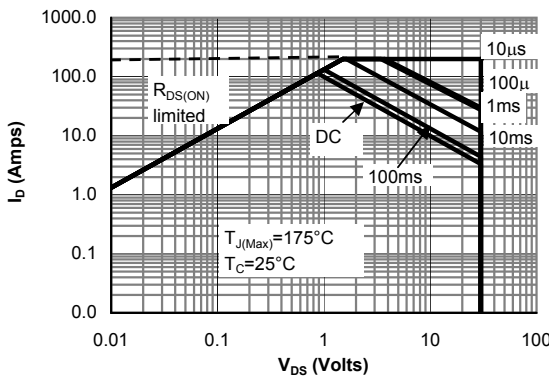

Figure 9: Maximum Forward Biased Safe Operating Area (Note F)

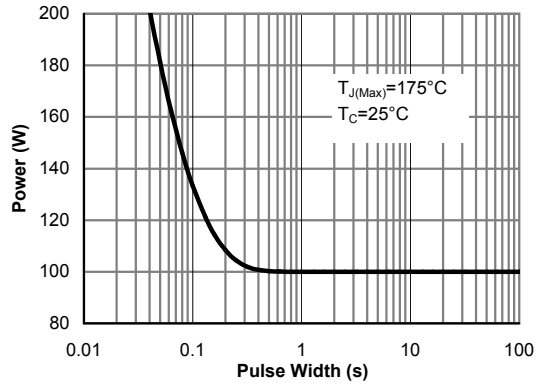

Figure 10: Single Pulse Power Rating Junction-to-Case (Note F)

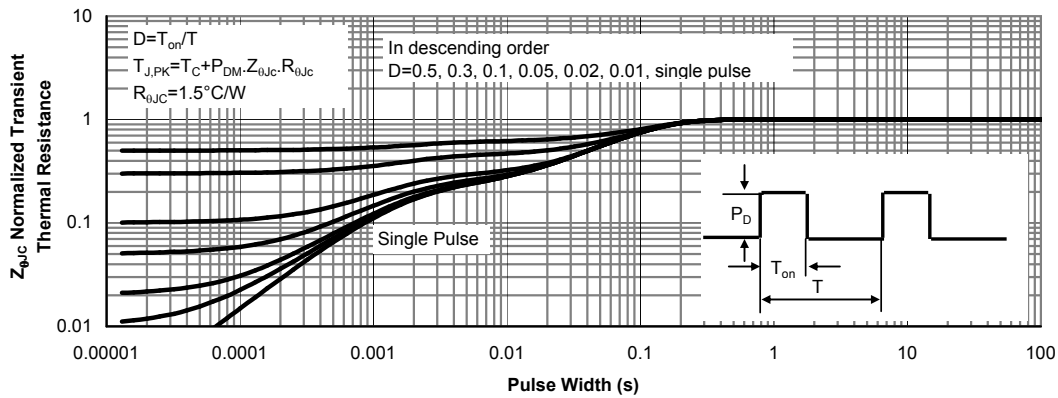

Figure 11: Normalized Maximum Transient Thermal Impedance (Note F)

TYPICAL ELECTRICAL AND THERMAL CHARACTERISTICS

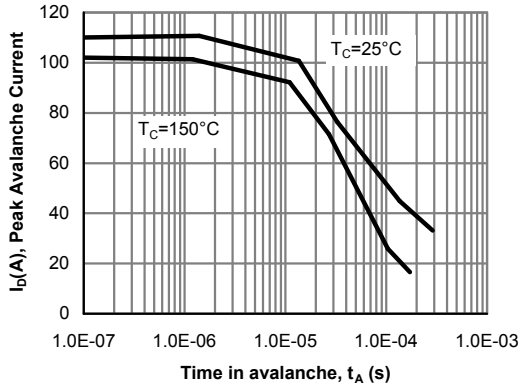

Figure 12: Single Pulse Avalanche capability

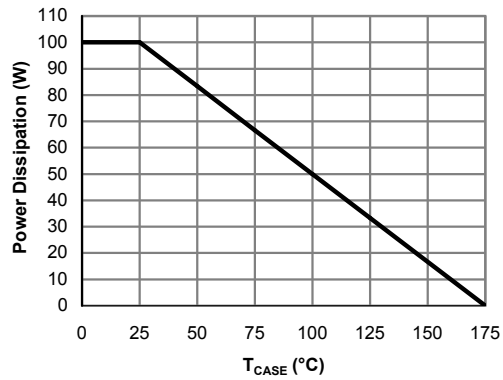

Figure 13: Power De-rating (Note B)

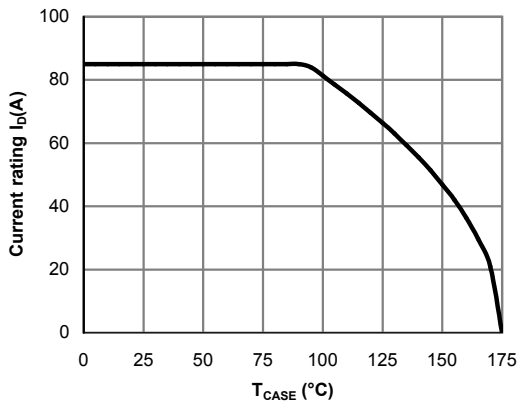

Figure 14: Current De-rating (Note B)

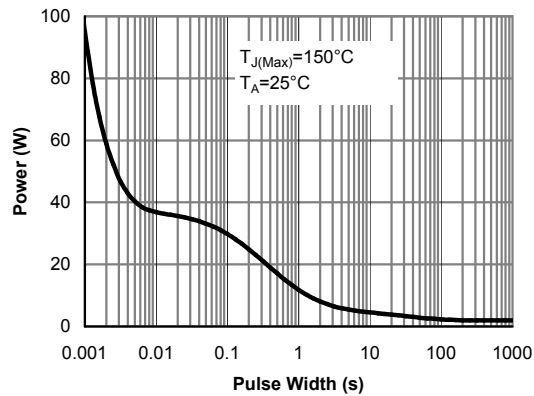

Figure 15: Single Pulse Power Rating Junction-to-Ambient (Note G)

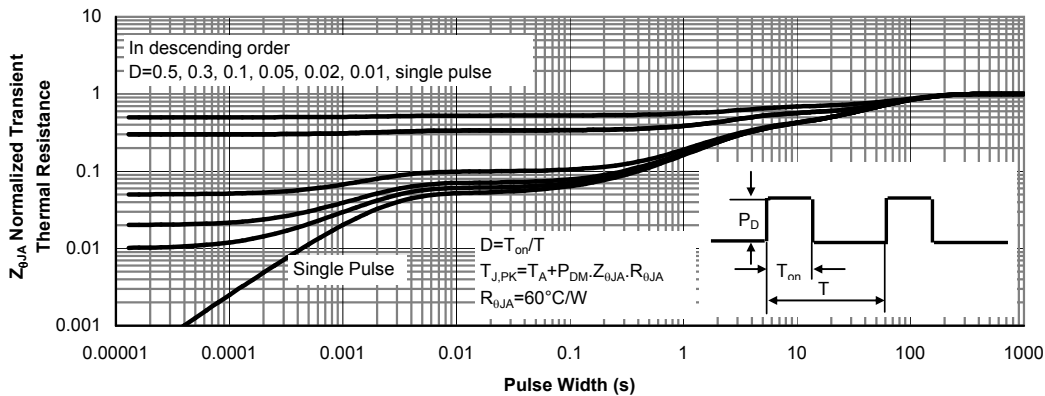
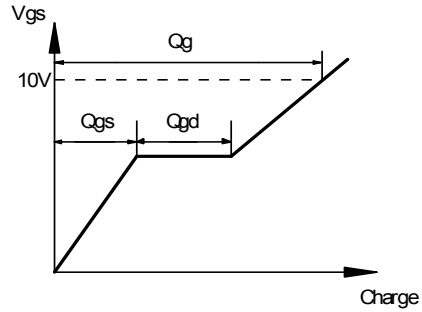
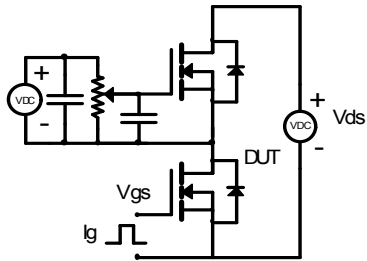
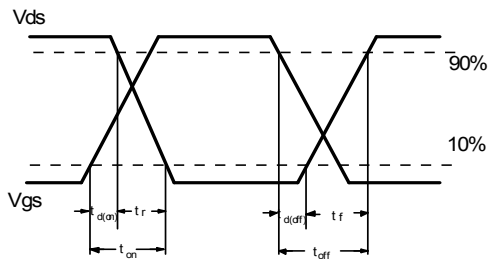
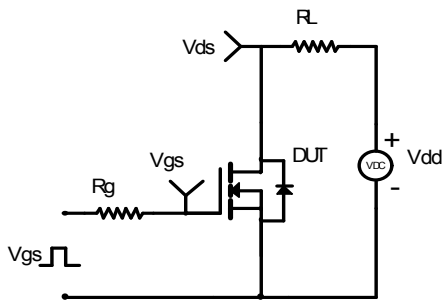

Figure 16: Normalized Maximum Transient Thermal Impedance (Note G)

Gate Charge Test Circuit & Waveform



Resistive Switching Test Circuit & Waveforms



Unclamped Inductive Switching (UIS) Test Circuit & Waveforms

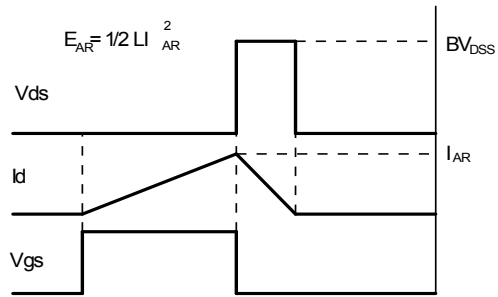
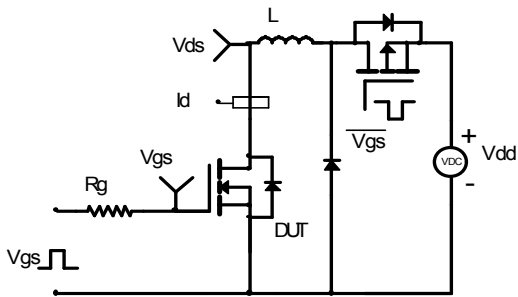

Diode Recovery Test Circuit & Waveforms

