

Leaded Actuators, 51um +/-9um, 800 N

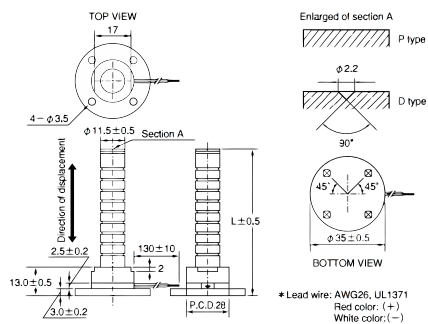

Dimensions (mm)		
Symbol	Dimension	Tolerance
L	72.4	+/-0.5

General Information	
Supplier:	KEMET
Part Type Description:	Metal Sealed Type Multilayer Piezoelectric Actuators

Specifications	
Displacement:	51um +/-9um
Temperature Range:	-25/+85C
Voltage:	150 VDC
Capacitance:	4.5 uF +/-20%
Resonant Frequency:	10 kHz
Resonant Frequency:	12 kHz (Without Flange)
Insulation Resistance:	10 MOhms
Dissipation Factor:	5%
Generated Force:	800 N