

Model No: XT19TD00-04
 Product Line: Tymphany

Rev: 1
 Last Update: 2017-03-03 02:00:02

Product Description

This member of the XT tweeter family utilizes two Tymphany technologies to deliver exceptional sound quality: the ring radiator patent, and the central waveguide patent. This model features a 4 ohm 19 mm voice coil, mounted in a ferrite magnet motor. The tweeter also features a rear chamber to create extended low frequency response. The faceplate features recessed mounting holes which minimizes reflections off of mounting screws.



Mechanical Drawing

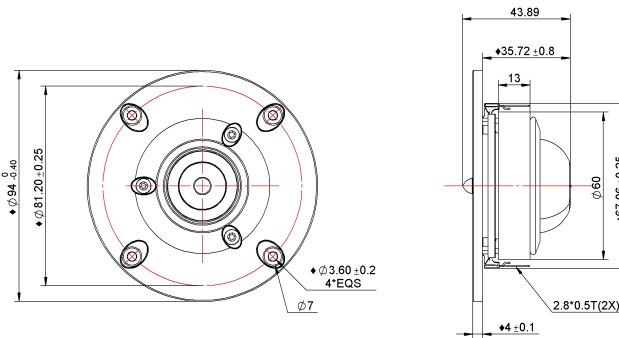

Specifications

DC Resistance	Revc	Ohms	2.86	5.0%	Energy Bandwidth Product	EBP	(1/Qes)*fs
Minimum Impedance	Zmin	Ohms	3.28	7.5%	Moving Mass	Mms	g
Voice Coil Inductance	Le	mH	0.01		Suspension Compliance	Cms	um/N
Resonant Frequency	Fs	Hz	762.77	15%	Effective Cone diameter	D	cm
Mechanical Q Factor	Qms		3.05		Effective Piston Area	Sd	cm ²
Electrical Q Factor	Qes		0.83		Effective Volume	Vas	L
Total Q Factor	Qts		0.65		Motor Force Factor	BL	Tm
Ratio Fs/Qts	F	Fs/Qts	1171.69		Motor Efficiency Factor	β	(T*M ²)/Ohms
Half Space Sensitivity @2.83V	db@2.83V/1M	dB	89.13	+/- 1.0db	Voice coil former Material	VCfm	ASV
Half Space Sensitivity @1W/1M	db@1W/1M	dB	85.2	+/- 1.0db	Voice coil inner diameter	VCd	mm
Gap Height	Gh	mm	2.5		Rated Noise Power	P	W
Maximum Linear Excursion	Xmax	mm	0.4		Test Spectrum Bandwidth		700Hz - 20kHz
Ferrofluid Type	FF				Driver Size	Inch	19 mm
Driver Mass	Kg		0.32				

Frequency and Impedance Response

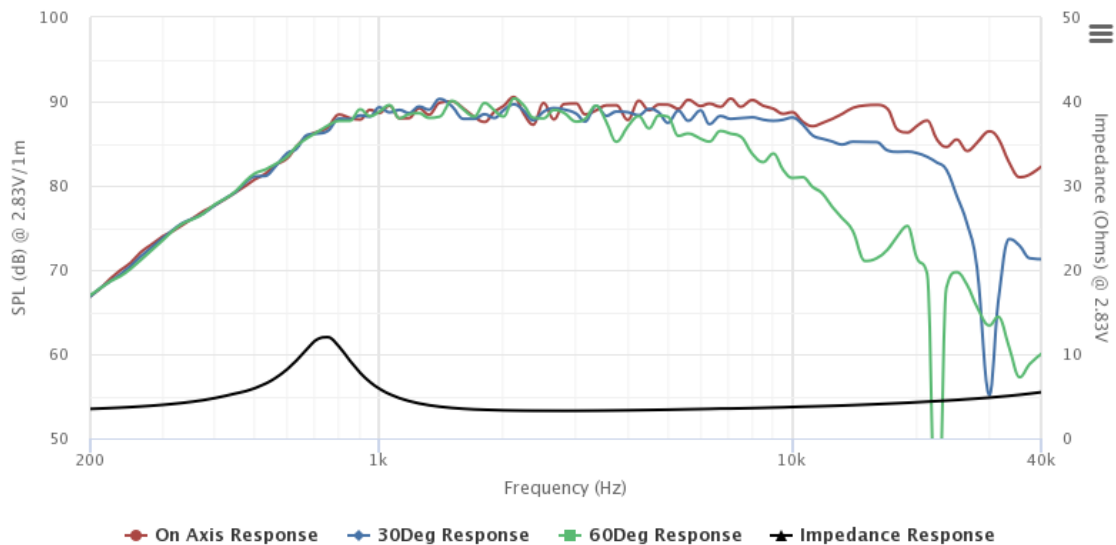

Highcharts.com