

PRODUCT DATASHEET

Leila series

last update 3/11/2016

Product number	FCN11455_LZ1-M2		
Family	Leila	FWHM	(simulated) 28
Type	Pack	Efficiency	-
LED	P4	cd/lm	-
Color	White	Gerber File	Available
Diameter	21.6 mm		
Height	14.7 mm		
Style	Round		
Optic Material	-		
Holder Material	-		
Fastening	["glue"]		
Status	Production ready		
Product number	FCN10788_LZ1-RS		
Family	Leila	FWHM	10 degrees
Type	Pack	Efficiency	95 %
LED	P4	cd/lm	-
Color	White	Gerber File	Available
Diameter	21.6 mm		
Height	14.65 mm		
Style	Round		
Optic Material	-		
Holder Material	-		
Fastening	["glue"]		
Status	Production ready		
Product number	FCN10790_LZ1-D		
Family	Leila	FWHM	14 degrees
Type	Pack	Efficiency	92 %
LED	P4	cd/lm	-
Color	White	Gerber File	Available
Diameter	21.6 mm		
Height	14.65 mm		
Style	Round		
Optic Material	-		
Holder Material	-		
Fastening	["glue"]		
Status	Production ready		
Product number	FCN10787_LZ1-M		
Family	Leila	FWHM	26 degrees
Type	Pack	Efficiency	91 %
LED	P4	cd/lm	-
Color	White	Gerber File	Available
Diameter	21.6 mm		
Height	14.65 mm		
Style	Round		
Optic Material	-		
Holder Material	-		
Fastening	["glue"]		
Status	Production ready		

PRODUCT DATASHEET

Leila series

last update 3/11/2016

Product number	FCN10789_LZ1-REC		
Family	Leila	FWHM	36+24 degrees
Type	Pack	Efficiency	-
LED	P4	cd/lm	-
Color	White	Gerber File	Available
Diameter	21.6 mm		
Height	14.65 mm		
Style	Round		
Optic Material	-		
Holder Material	-		
Fastening	["glue"]		
Status	Production ready		
Product number	FCN11102_LZ1-O-90		
Family	Leila	FWHM	40+16 degrees
Type	Pack	Efficiency	90 %
LED	P4	cd/lm	-
Color	White	Gerber File	Available
Diameter	21.6 mm		
Height	14.65 mm		
Style	Round		
Optic Material	-		
Holder Material	-		
Fastening	["glue"]		
Status	Production ready		

NOTE: The typical divergence will be changed by different color, chip size and chip position tolerance. The typical total divergence is the full angle measured where the luminous intensity is half of the peak value.

Relative intensity of CA11640_LR2-O-90_(Rebel)

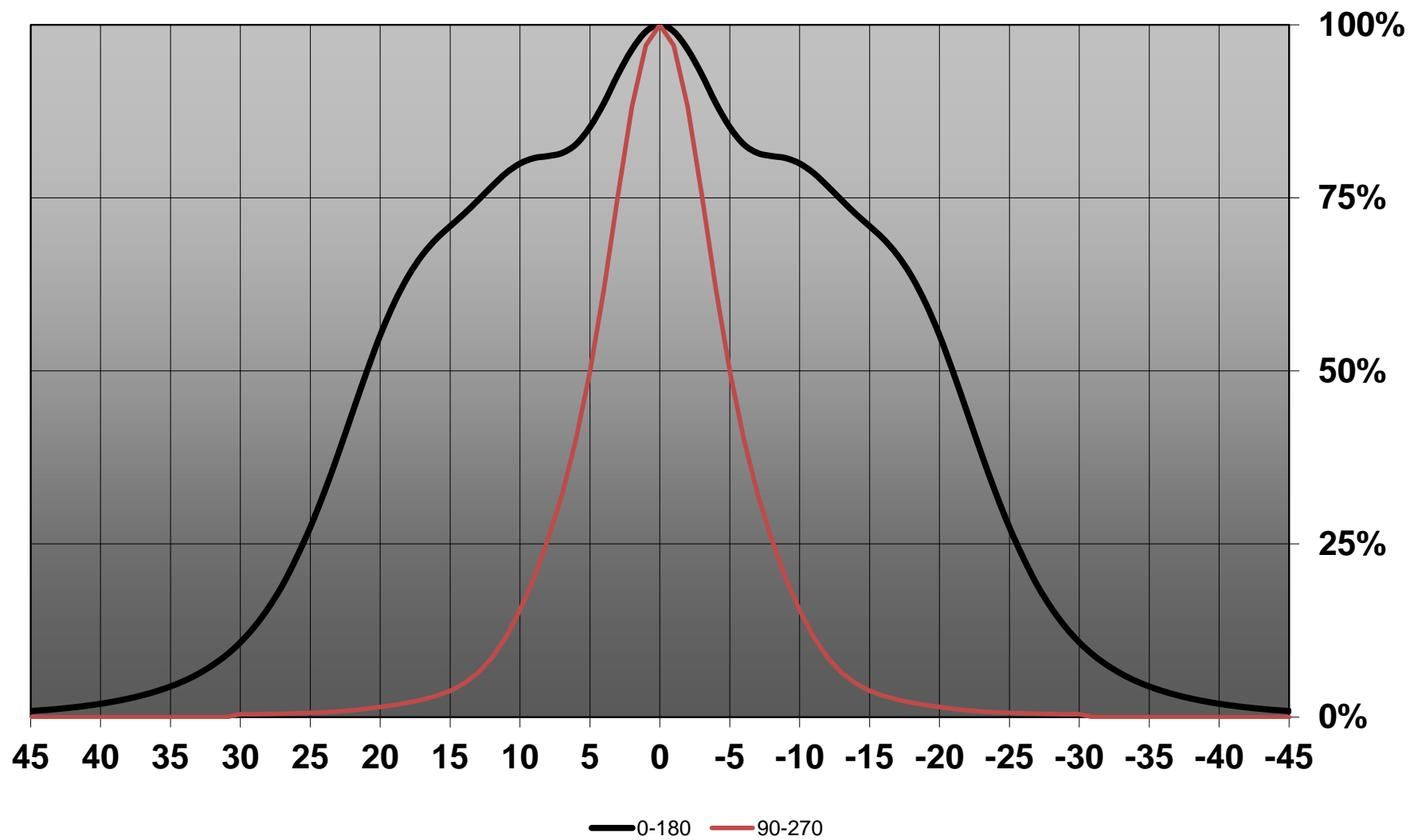

D

C

B

A

4

4

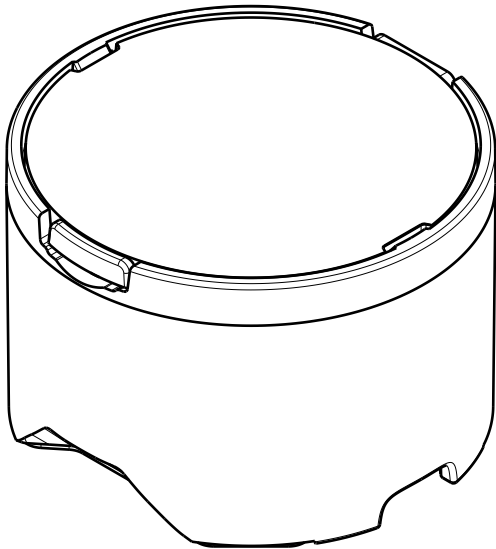

Isometric view
Scale: 3:1

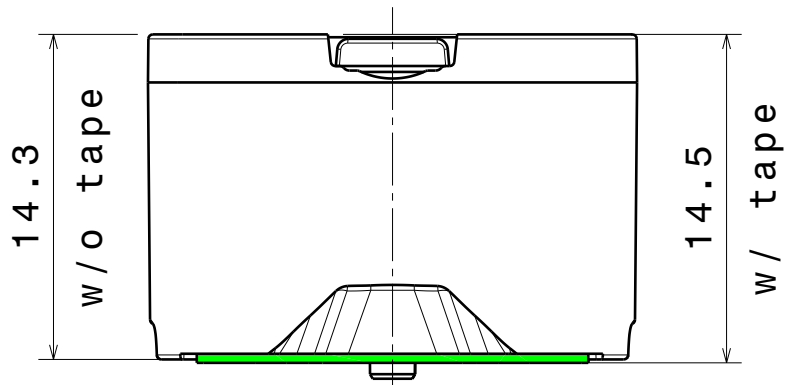

Front view
Scale: 3:1

3

3

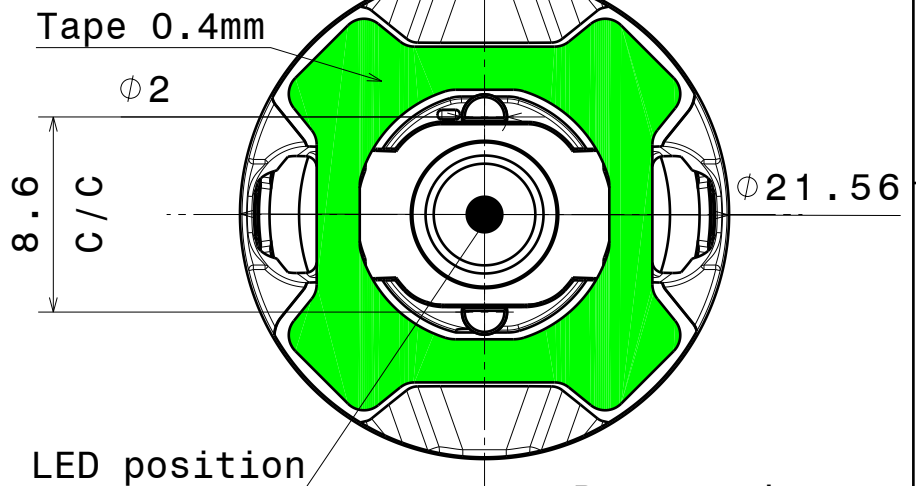

Bottom view
Scale: 3:1

2

2

Tolerances if not otherwise shown
According to DIN ISO 2768-1
Linear measures:
Up to 30mm class M, otherwise class C.
According to DIN ISO 2768-2
Form and position: class L



Ledil Oy
Salorankatu 10
FIN 24240 SALO
Finland

THIRD ANGLE PROJECTION:

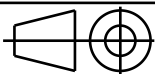

DRAWING TITLE

Leila_LR2-W

This drawing is the property
of LEDiL Oy. It may not be
reproduced, copied or
communicated without a written
agreement with LEDiL Oy."

SIZE PART NUMBER

A4

-

SCALE 3:1 WEIGHT

-

SHEET 1/1

D

A

1

1

Luminaire: Ledil Oy FA10804_LR1-RS FA10804_LR1-RS
Lamps: 1 x LUXEON REBEL

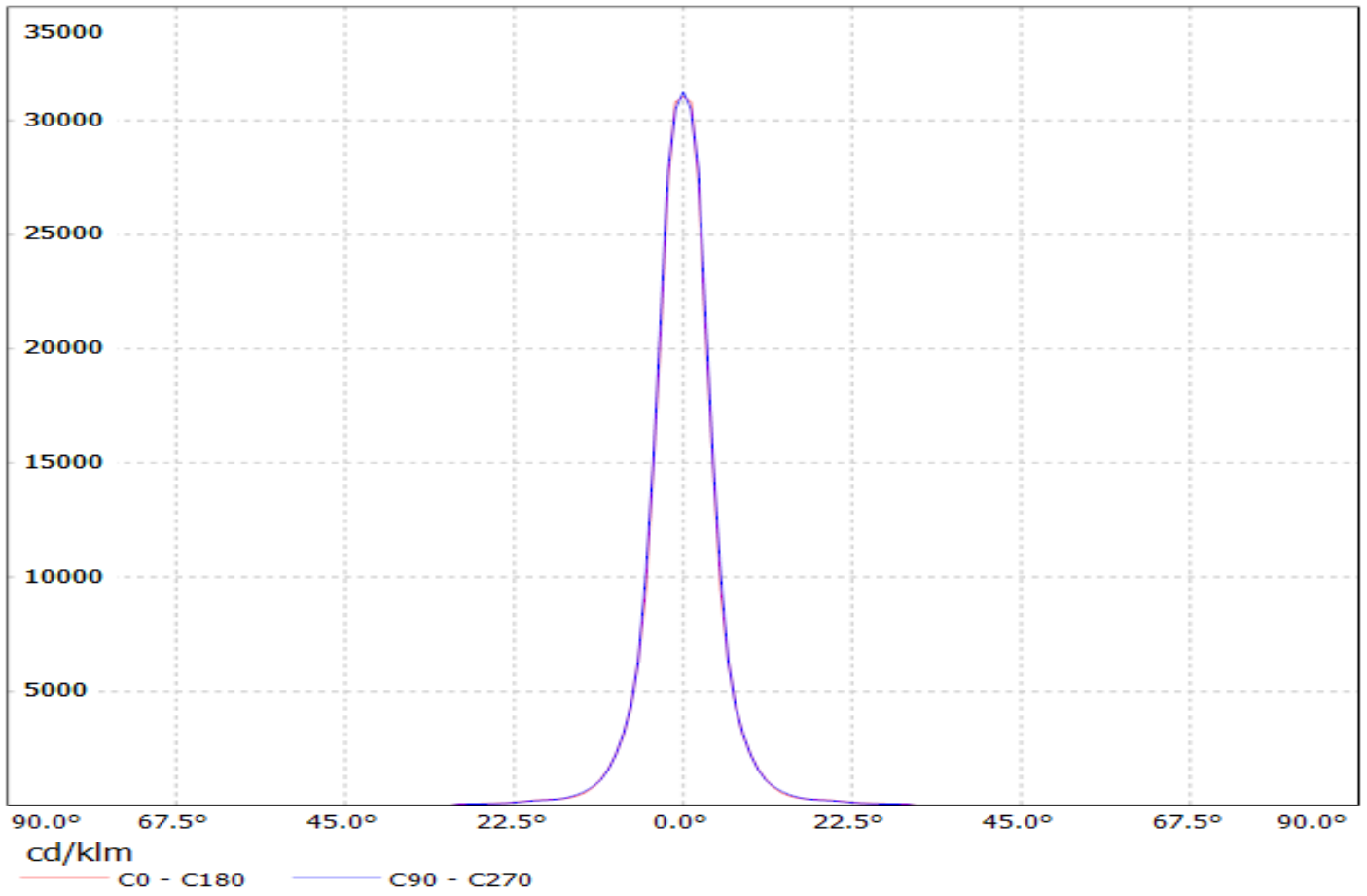

Luminaire: Ledil OY FCN11738_LR1-RS2-RE LOR=93%
Lamps: 1 x Luxeon Rebel 250mA 78lm

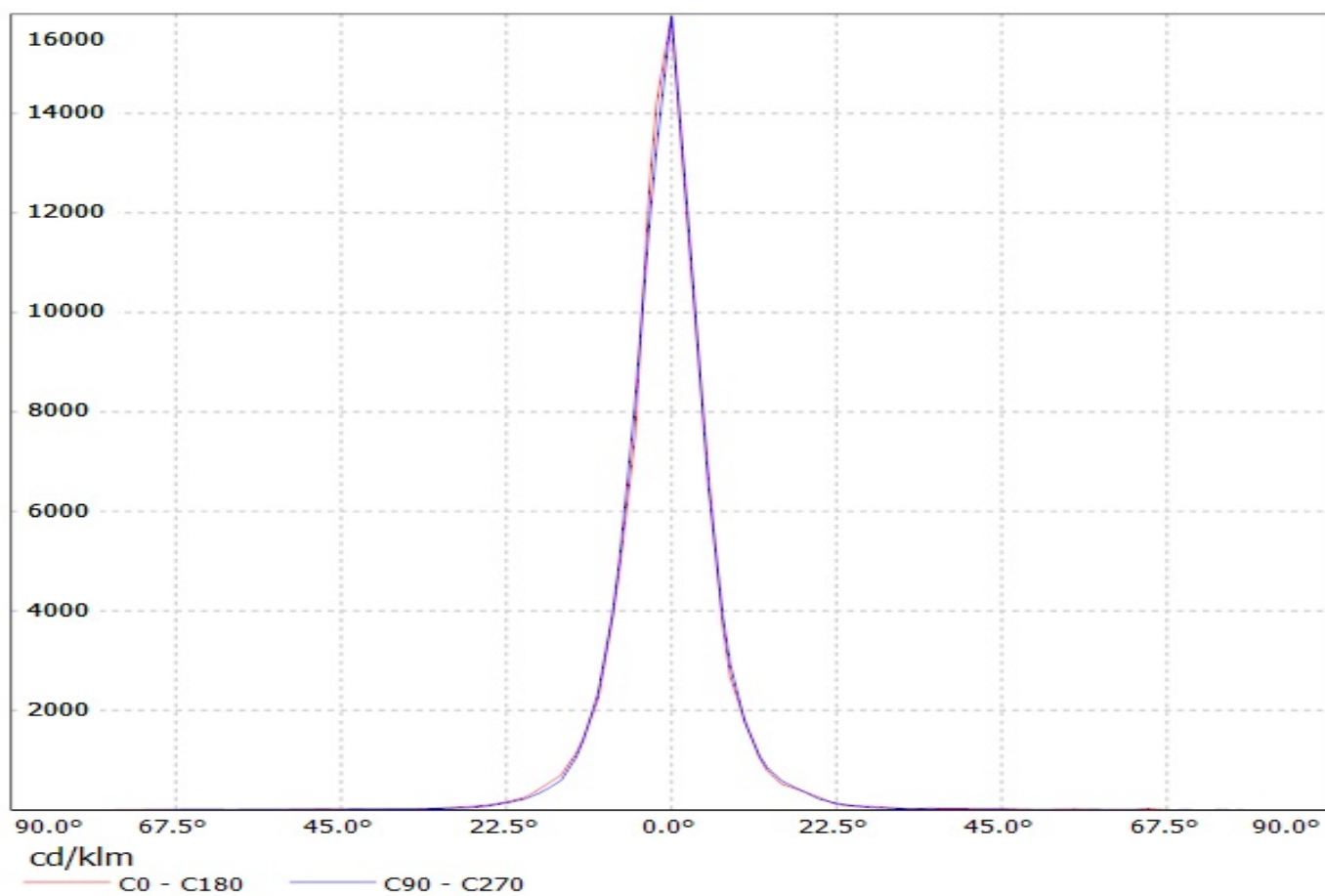

Luminaire: Ledil Oy FA10803_LR1-M FA10803_LR1-M
Lamps: 1 x Luxeon Rebel

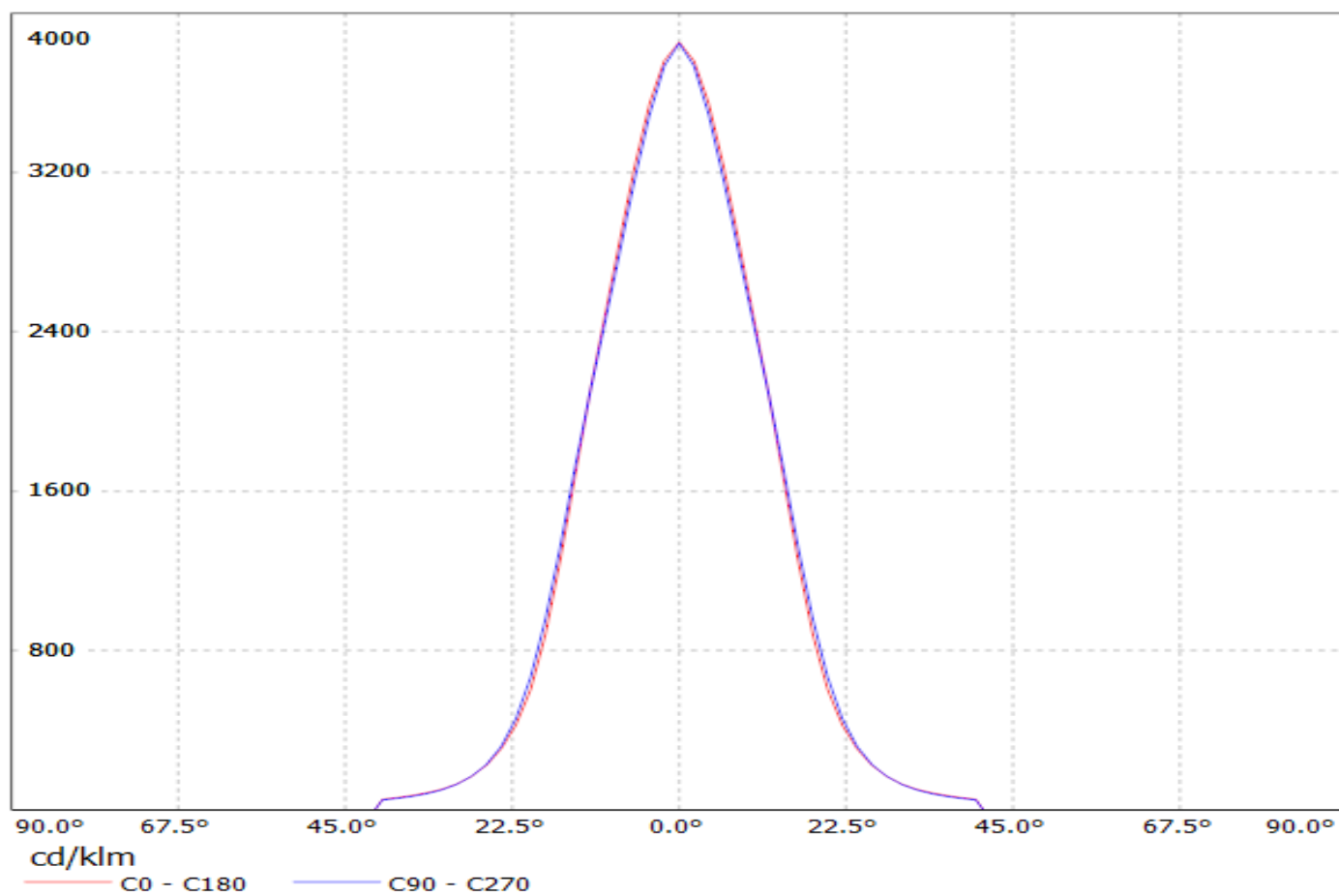

Luminaire: Ledil Oy FA10805_LR1-REC FA10805_LR1-REC
Lamps: 1 x Luxeon Rebel (white)

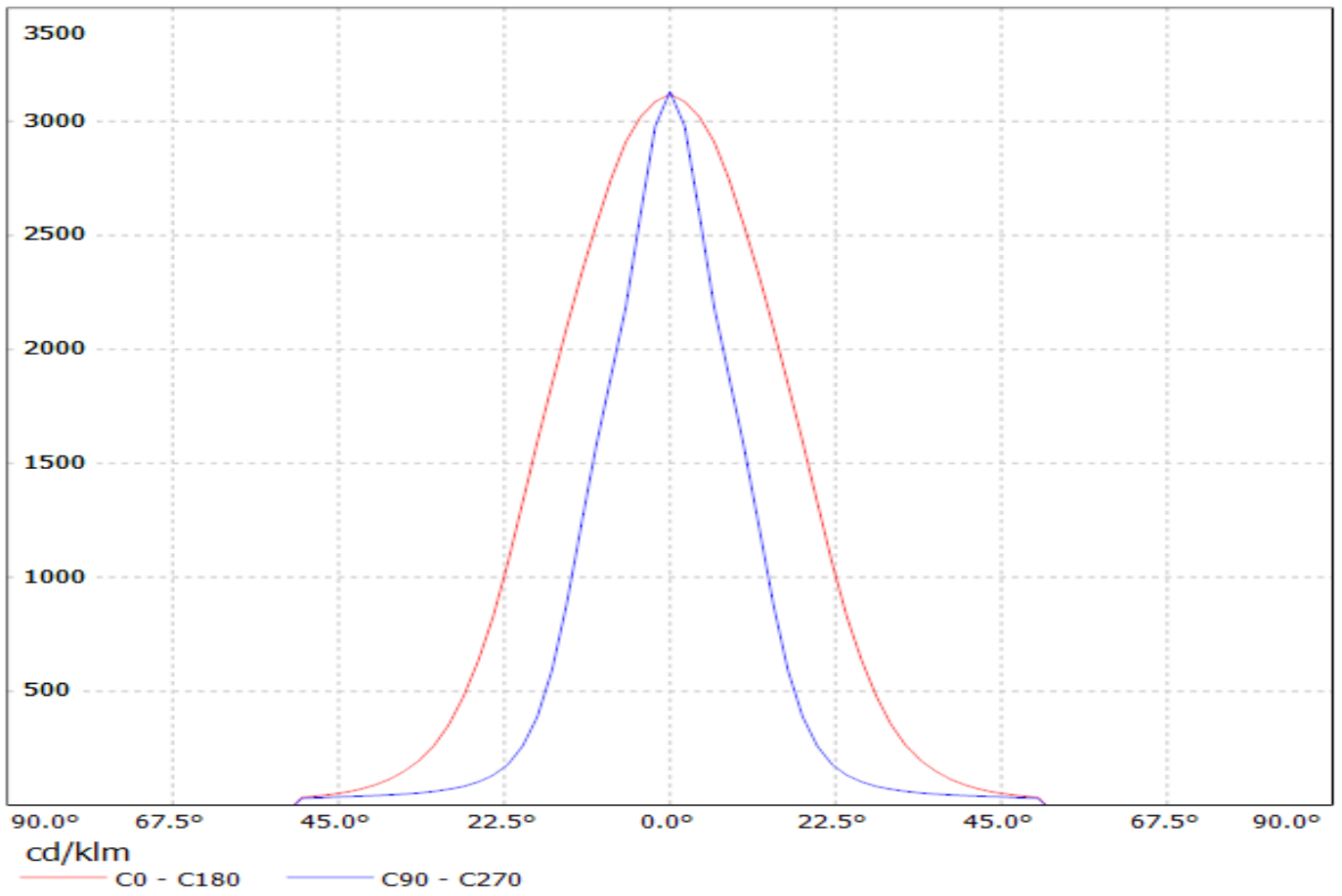

Luminaire: Ledil Oy FA10890_LR1-W FA10890_LR1-W
Lamps: 1 x Luxeon Rebel (white)

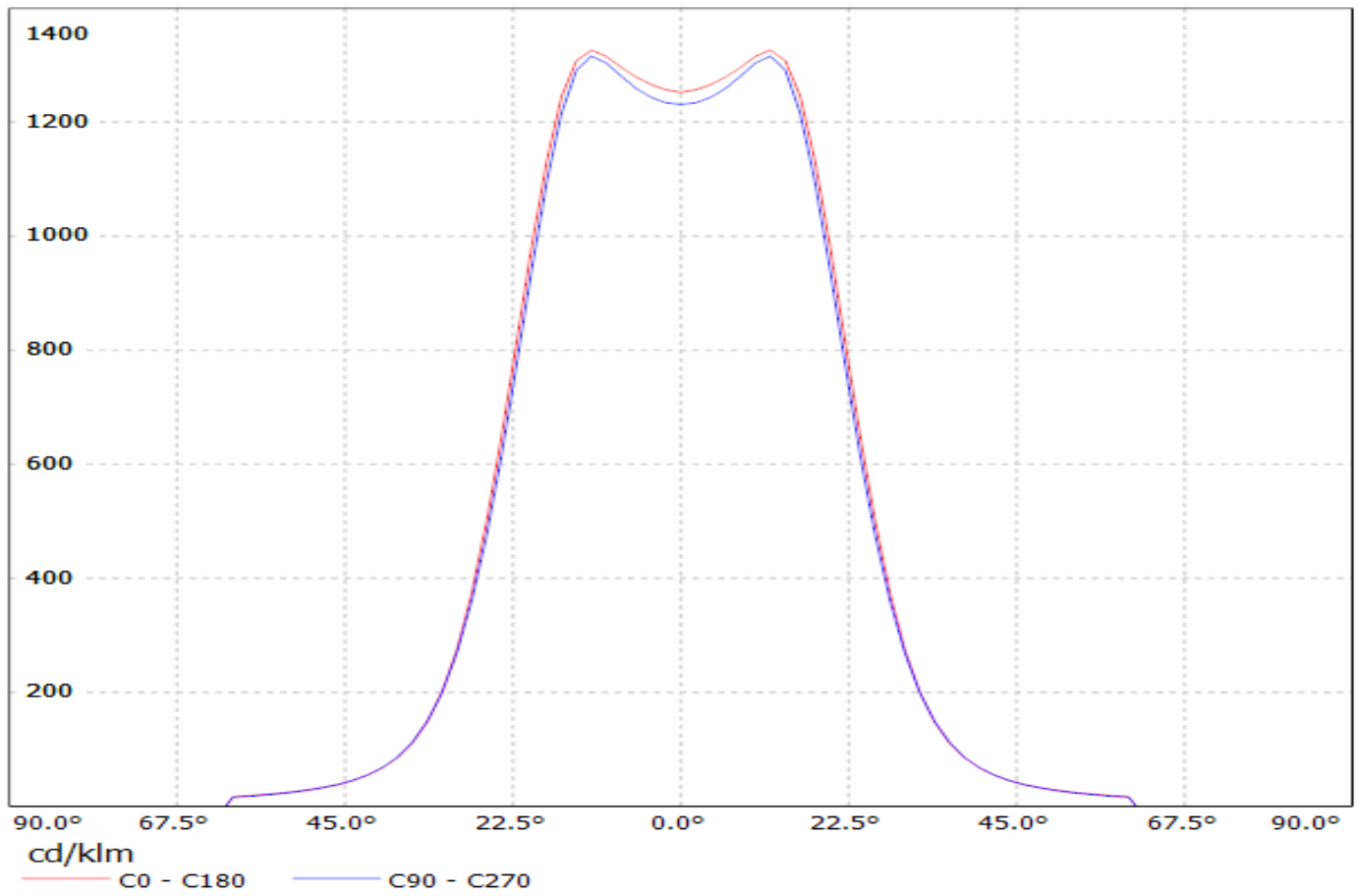

Luminaire: LEDiL Oy C13353_LEILA-R-CLIP16
Lamps: 1 x Luxeon Rebel 80.7lm @ 250mA

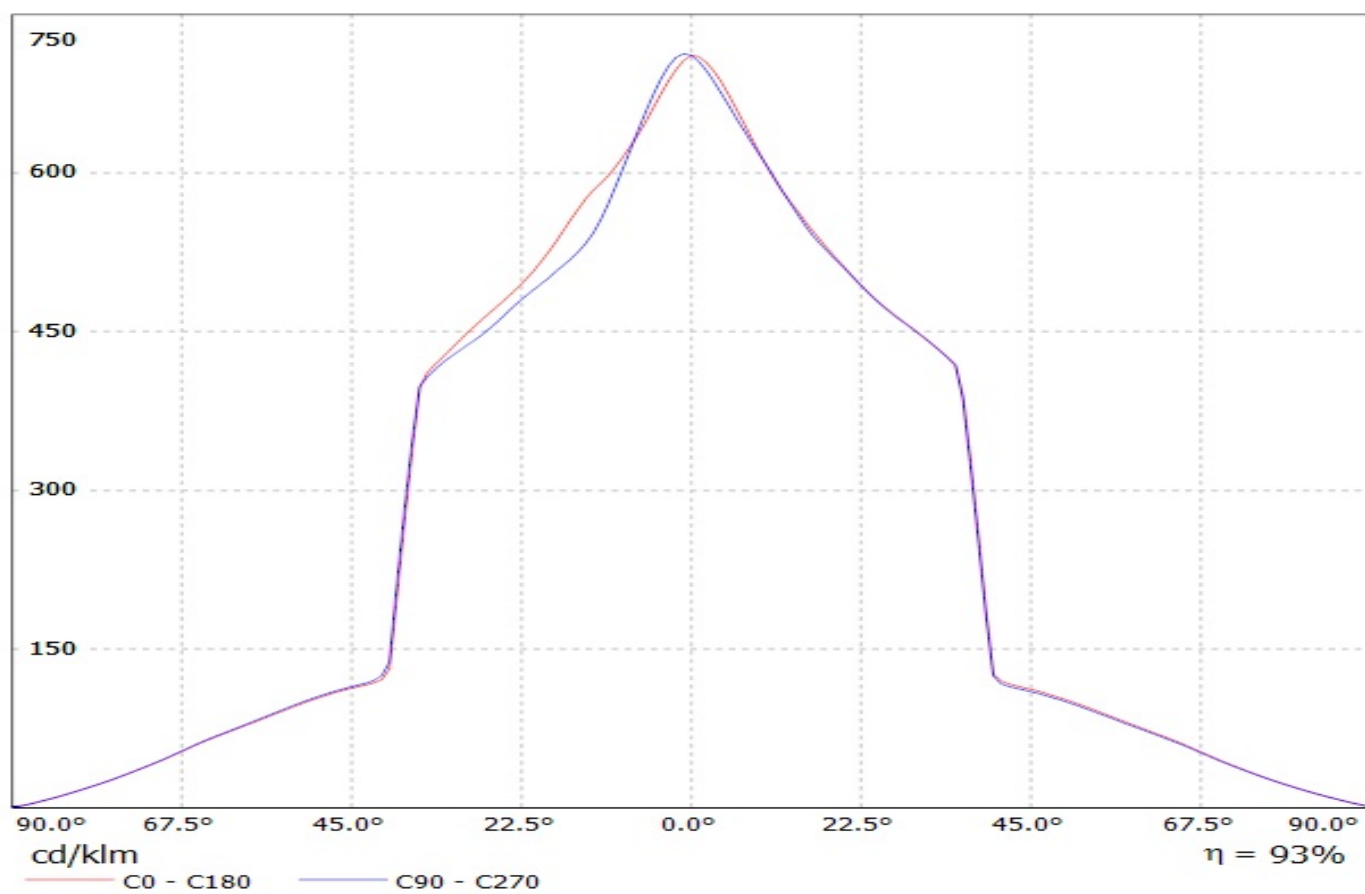

Luminaire: Ledil Oy FA10804_LR1-RS FA10804_LR1-RS
Lamps: 1 x LUXEON REBEL

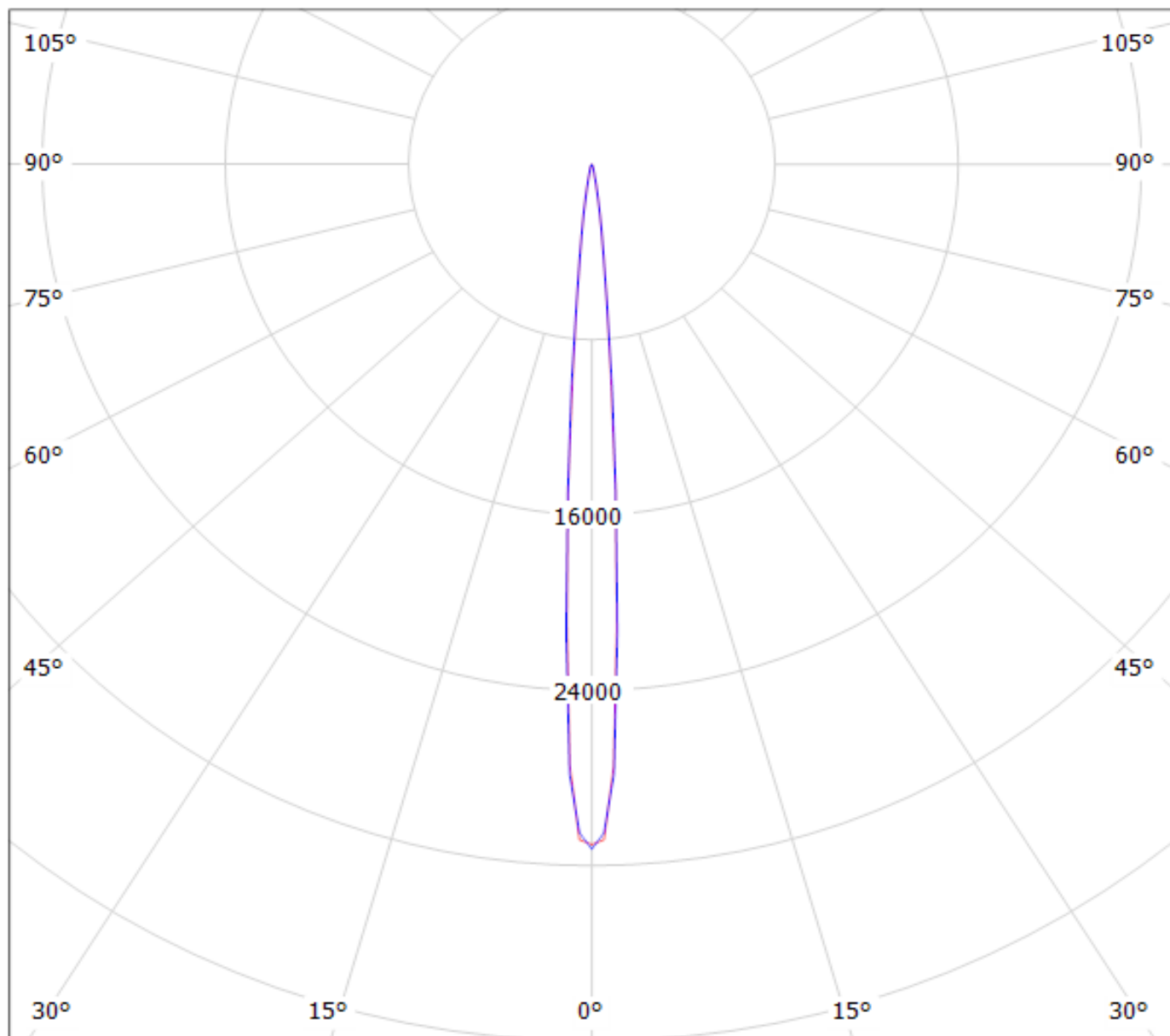

cd/klm

— C0 - C180

— C90 - C270

Luminaire: Ledil OY FCN11738_LR1-RS2-RE LOR=93%
Lamps: 1 x Luxeon Rebel 250mA 78lm

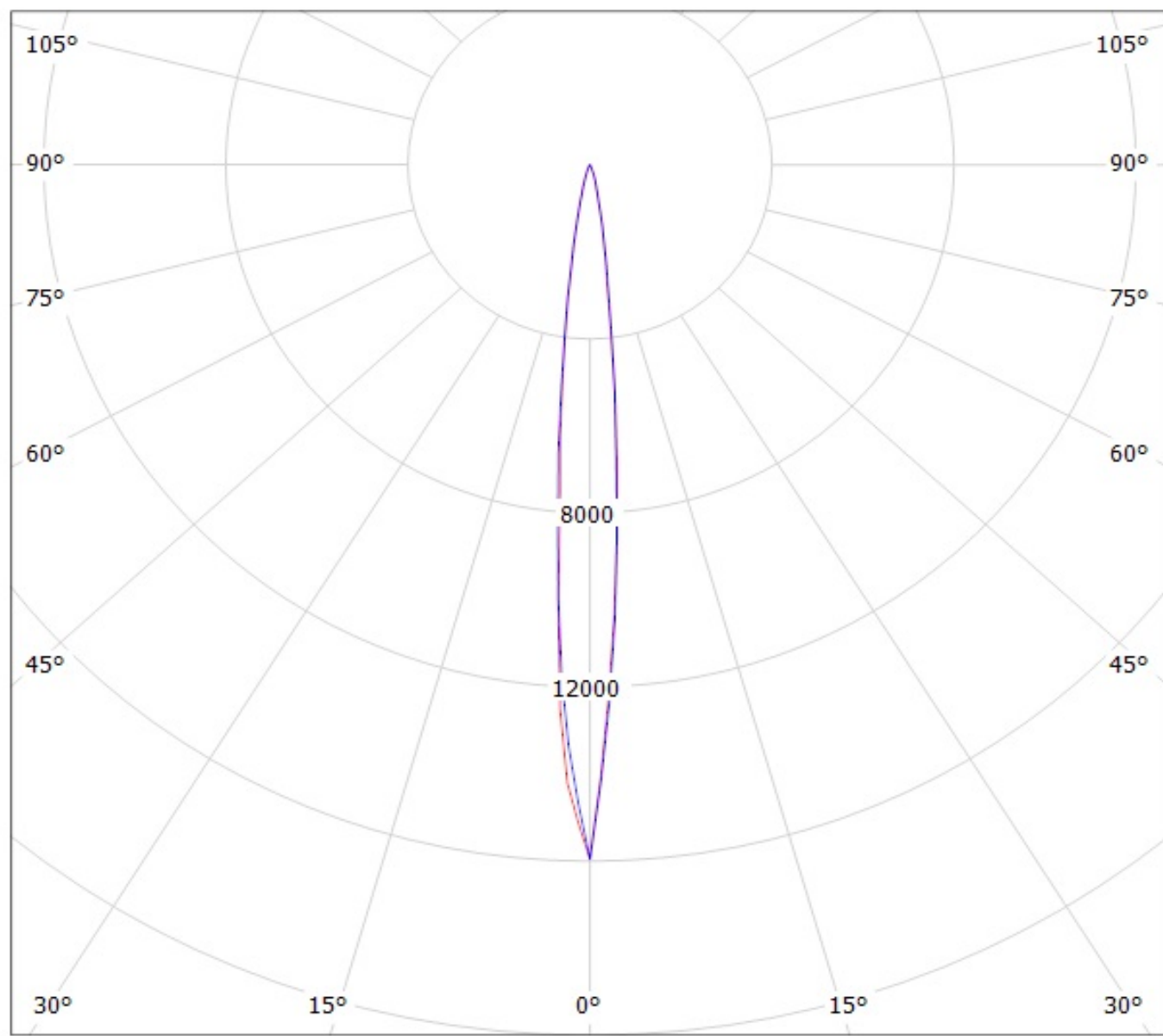

cd/klm

— C0 - C180

— C90 - C270

Luminaire: Ledil Oy FA10803_LR1-M FA10803_LR1-M
Lamps: 1 x Luxeon Rebel

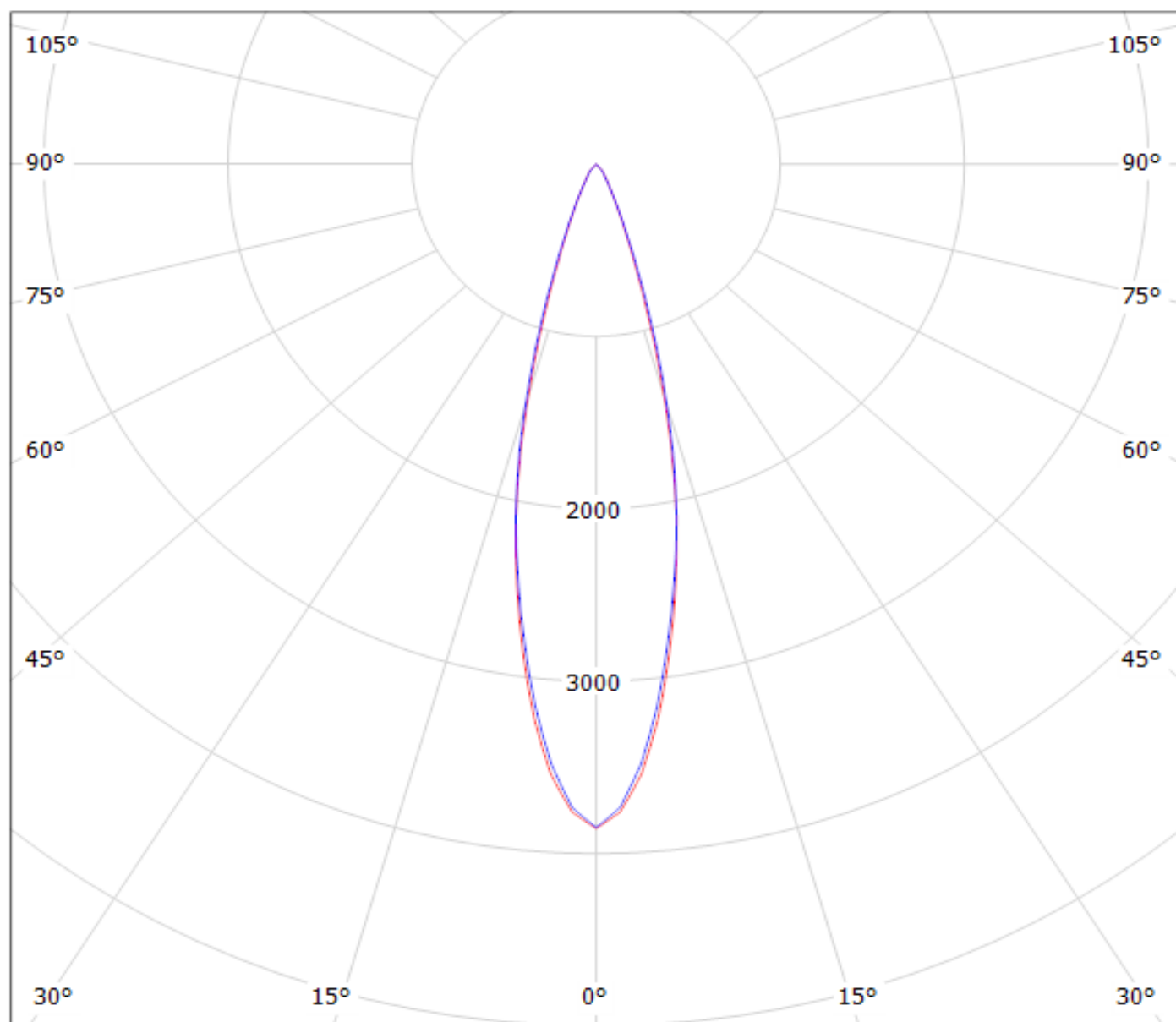

cd/klm

— C0 - C180

— C90 - C270

Luminaire: Ledil Oy FA10805_LR1-REC FA10805_LR1-REC
Lamps: 1 x Luxeon Rebel (white)

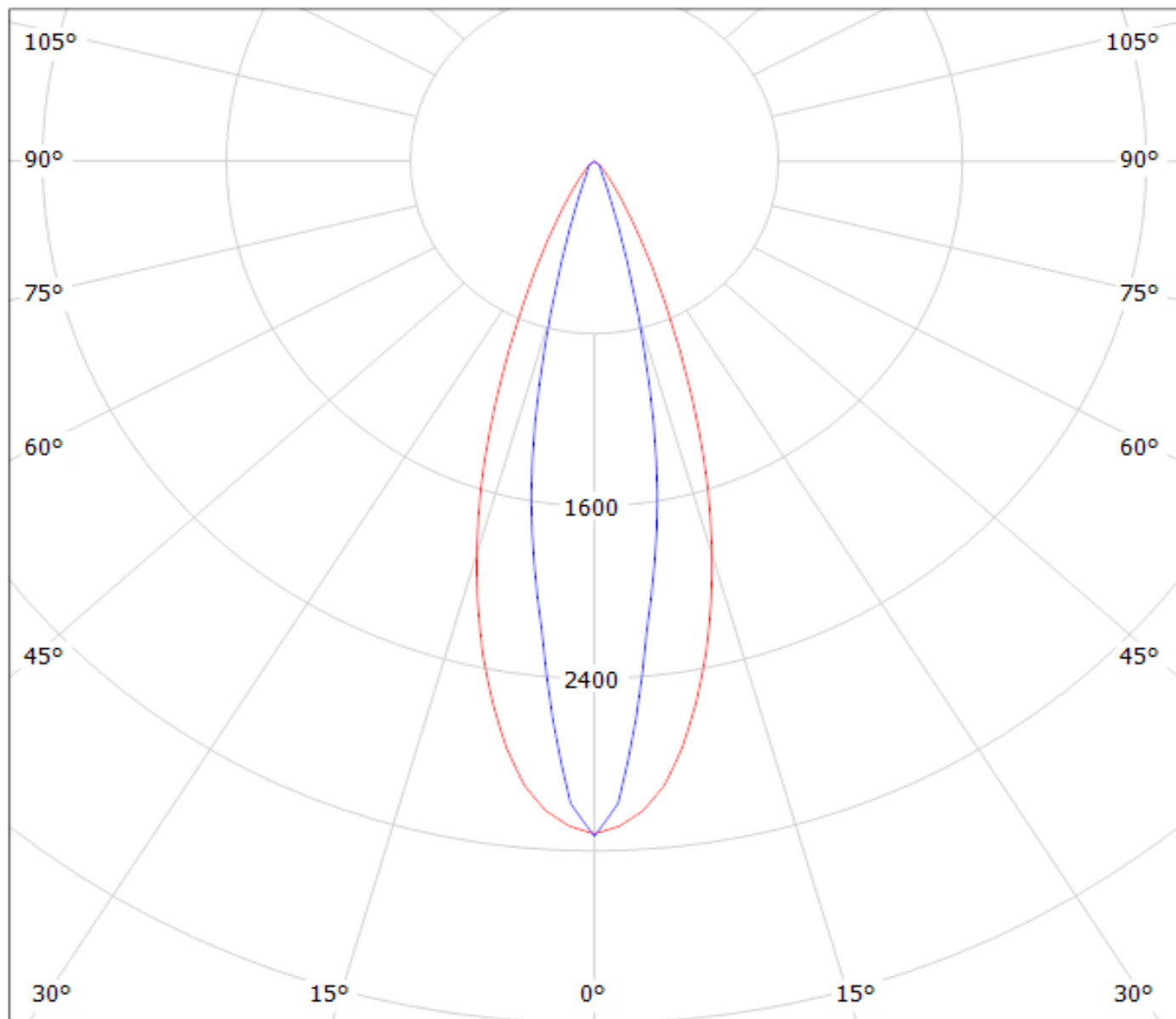

cd/klm

— C0 - C180

— C90 - C270

Luminaire: Ledil Oy FA10890_LR1-W FA10890_LR1-W
Lamps: 1 x Luxeon Rebel (white)

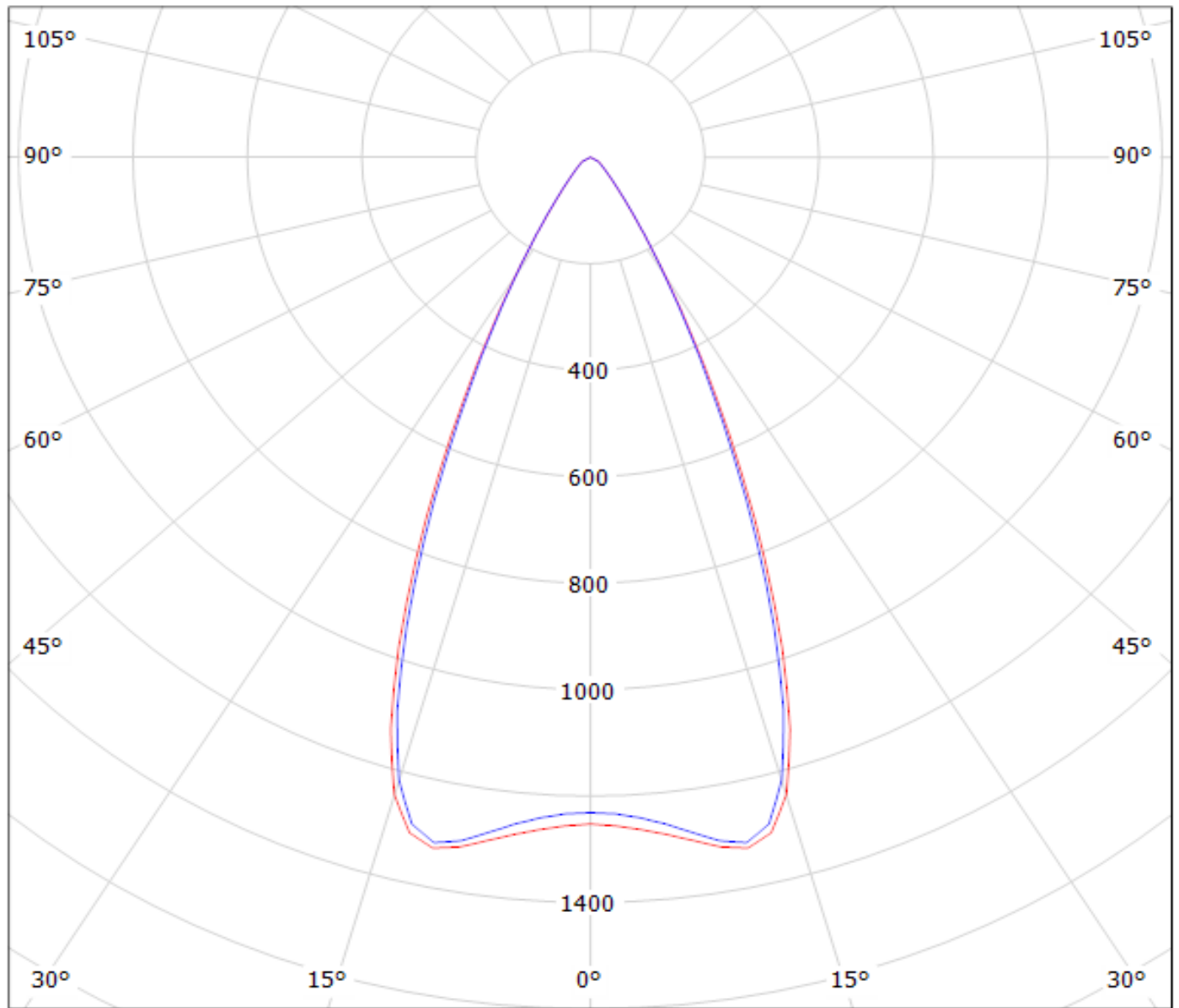

cd/klm

— C0 - C180

— C90 - C270

Luminaire: LEDiL Oy C13353_LEILA-R-CLIP16
Lamps: 1 x Luxeon Rebel 80.7lm @ 250mA

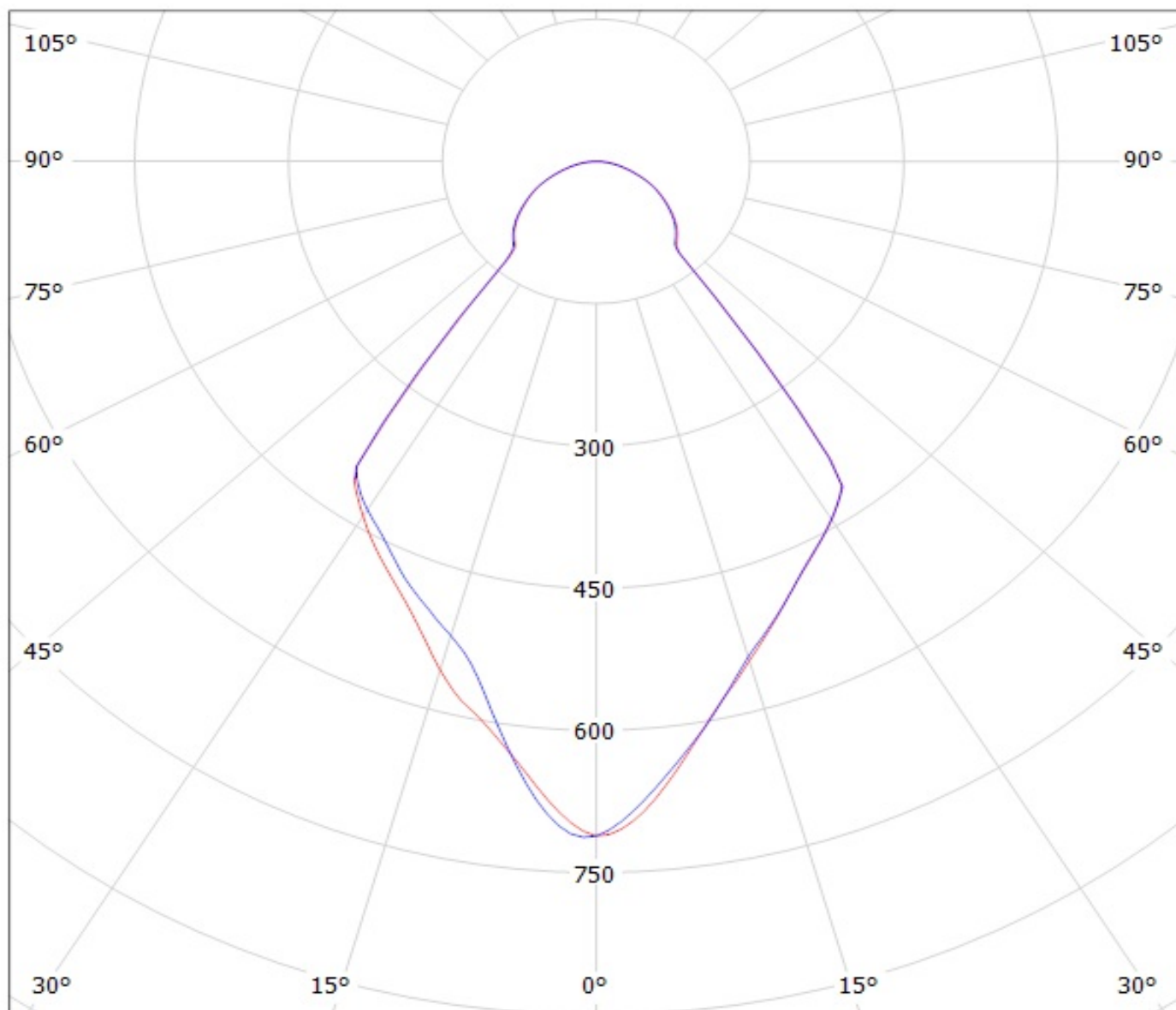

cd/klm

— C0 - C180 — C90 - C270

$\eta = 93\%$