

## DETAILS

<b>Product Number</b>	CN13520_MIRELLA-50-W-CL
<b>Family</b>	Mirella
<b>Type</b>	RefPack
<b>Color</b>	metal
<b>Diameter</b>	49,9 mm
<b>Height</b>	23,9 mm
<b>Style</b>	round
<b>Optic Material</b>	PC
<b>Holder Material</b>	
<b>Fastening</b>	glue
<b>Status</b>	production ready
<b>ROHS Compliant</b>	Yes
<b>Date Updated</b>	1/11/2016



## OPTICAL PROPERTIES

LED	Viewing	Light	Efficiency	cd/lm	Connector
	Angle	Beam			
BXRA LS	42 deg	Wide	84 %	1.400	-
CLL01x	48 deg	Wide	84 %	1.200	-
CLL02x/CLU02x (LES10)	46 deg	Wide	84 %	1.200	-
CLU720/721	55 deg	Wide	83 %	1.000	-
CLU710/711	48 deg	Wide	83 %	1.100	-
CLU700/701	44 deg	Wide	82 %	1.300	-
MT-G2	50 deg	Wide	84 %	1.100	-
CXA/B 15xx	46 deg	Wide	85 %	1.400	-
CXA/B 13xx	42 deg	Wide	81 %	1.500	-
CXA/B 1816 & CXA/B 1820 & CXA 1850	56 deg	Wide	82 %	1.100	-
XHP50	45 deg	Wide	84 %	1.200	-
XHP70	53 deg	Wide	84 %	1.000	-
MHD-E/G	50 deg	Wide	87 %	1.100	-
COB 4W	41 deg	Wide	84 %	1.500	-
LUXEON S1000	34 deg	Wide	84 %	1.700	-
LUXEON CoB 1202/1203	49 deg	Wide	84 %	1.200	-
CXM-9	48 deg	Wide	83 %	1.200	-
COB L-Type (LES 9)	47 deg	Wide	85 %	1.300	-
NSCxL036A	44 deg	Wide	83 %	1.300	-
Soleriq S13	57 deg	Wide	80 %	1.000	-
Duris S10	45 deg	Wide	82 %	1.300	-
Soleriq S9	sim: 50	Wide	sim: 87 %	sim: 1.200	-
ZC4/6	46 deg	Wide	80 %	1.300	-
STARK SLE PURE G3 LES10	45 deg	Wide	81 %	1.400	-

Relative intensity of CN13520\_MIRELLA-50-W-CL-(LS)

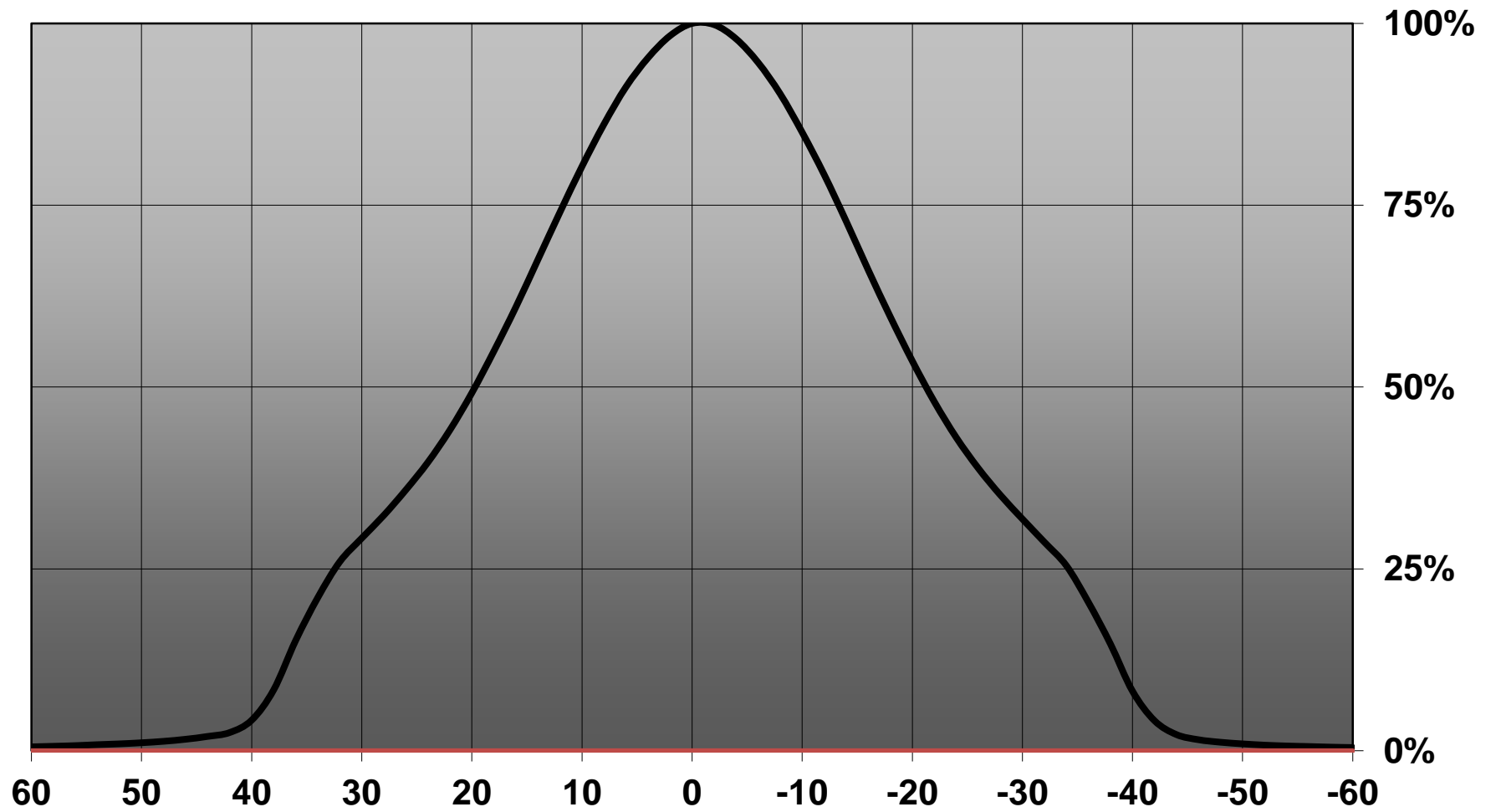

Relative intensity of CN13520\_MIRELLA-50-W-CL-(CLL010)

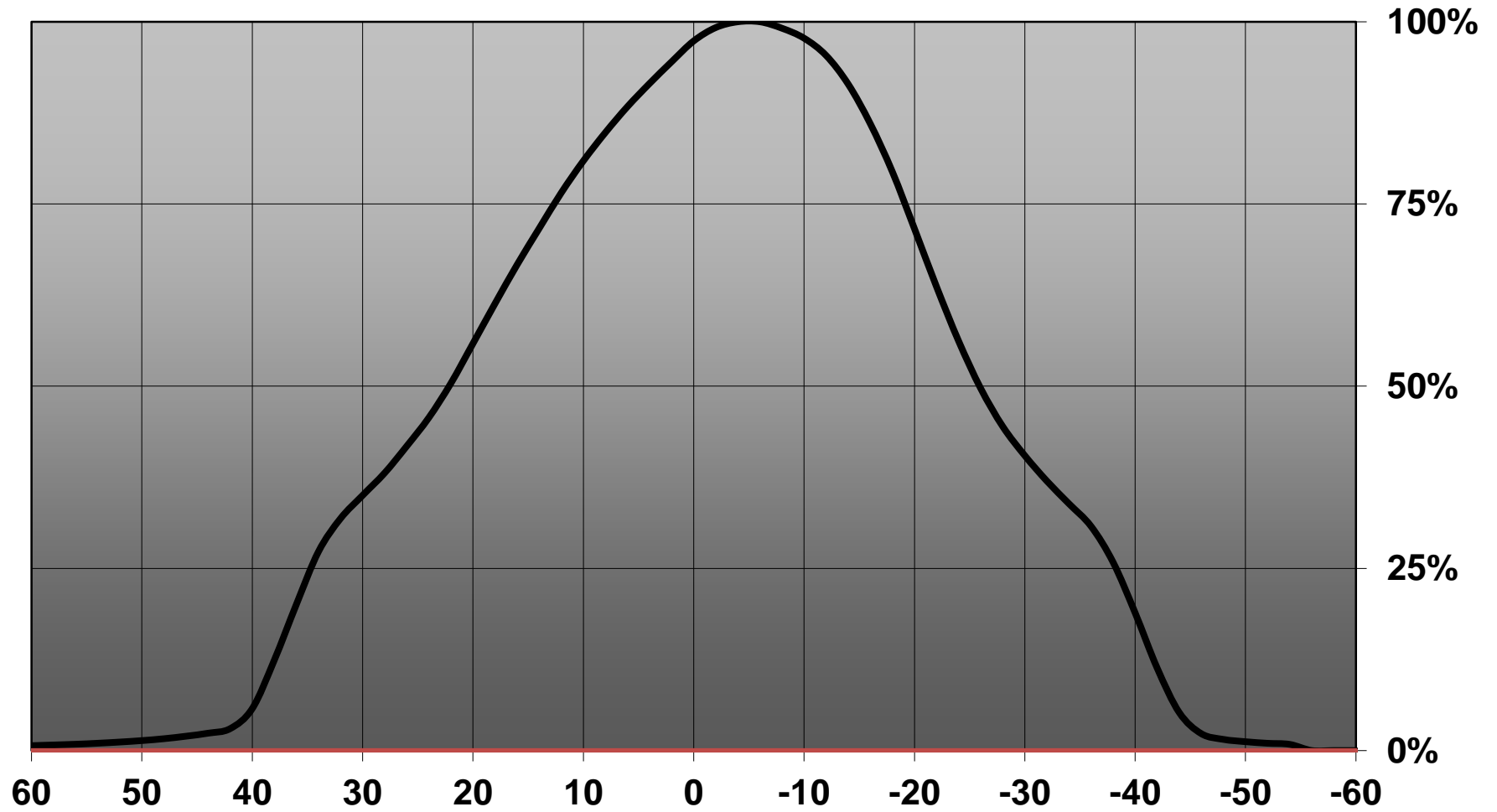

Relative intensity of CN13520\_MIRELLA-50-W-CL-(CLL020)

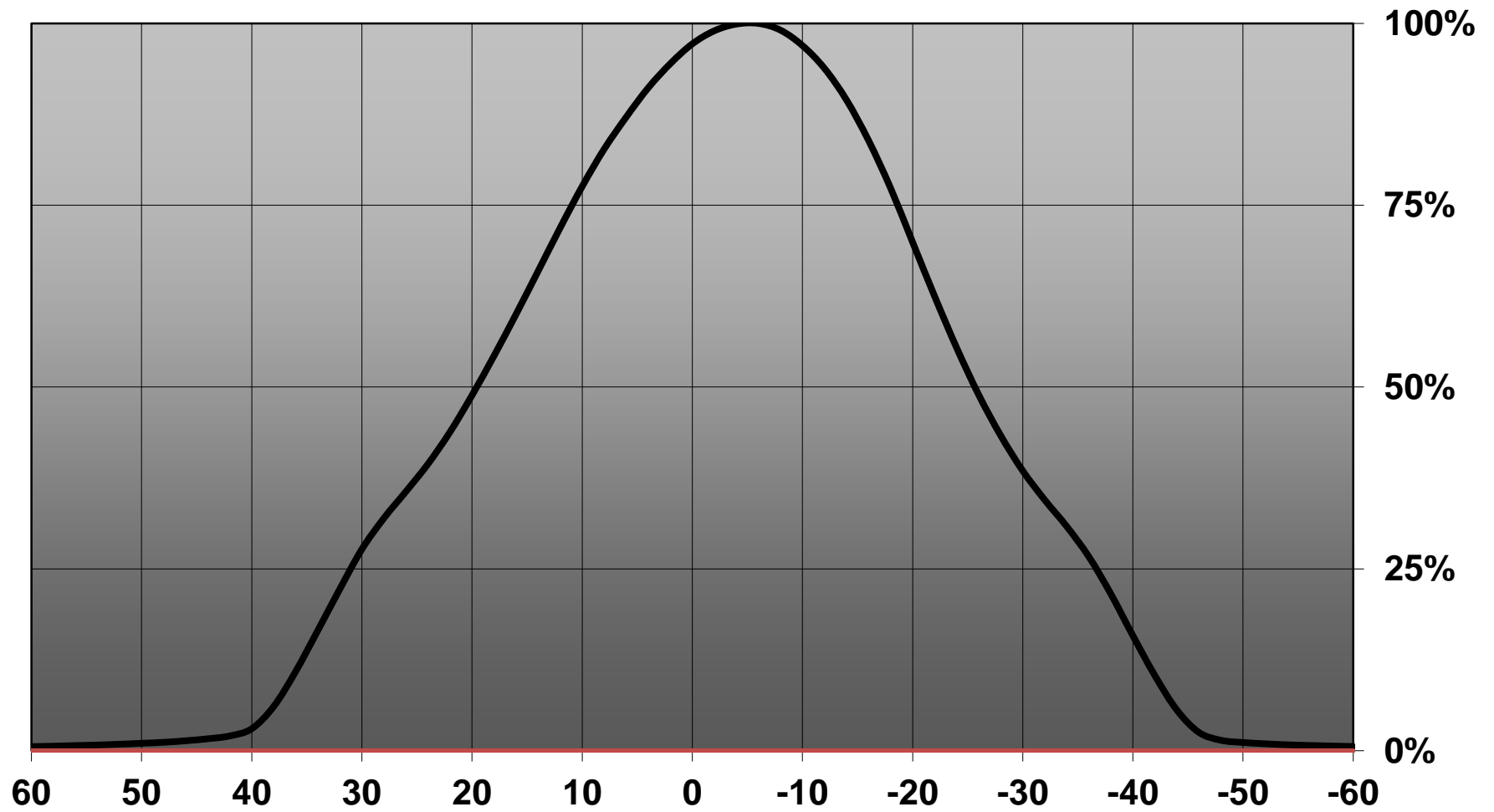

Relative intensity of CN13520\_MIRELLA-50-W-CL-(MTG2)

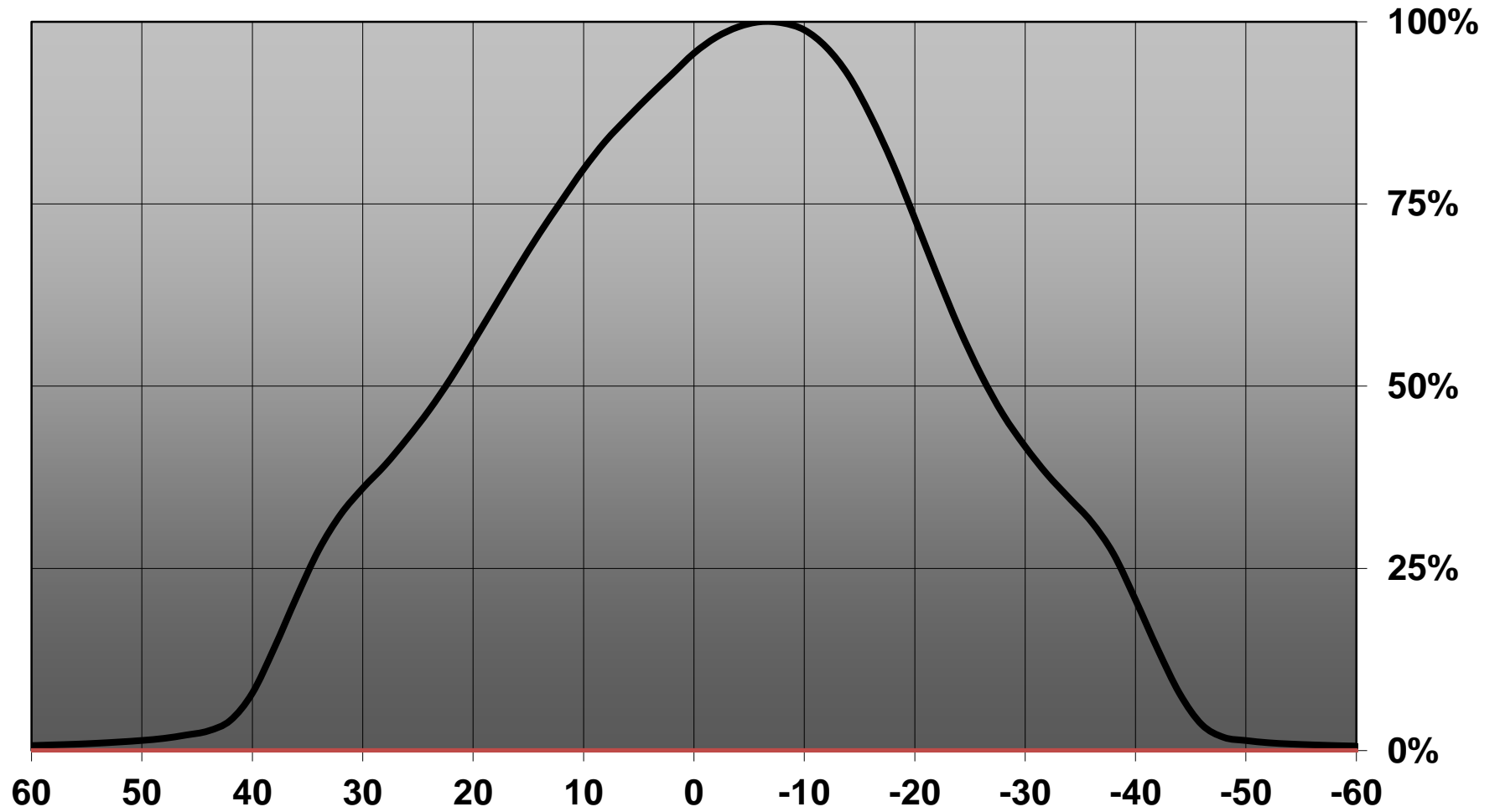

Relative intensity of CN13520\_MIRELLA-50-W-CL-(CXA15)

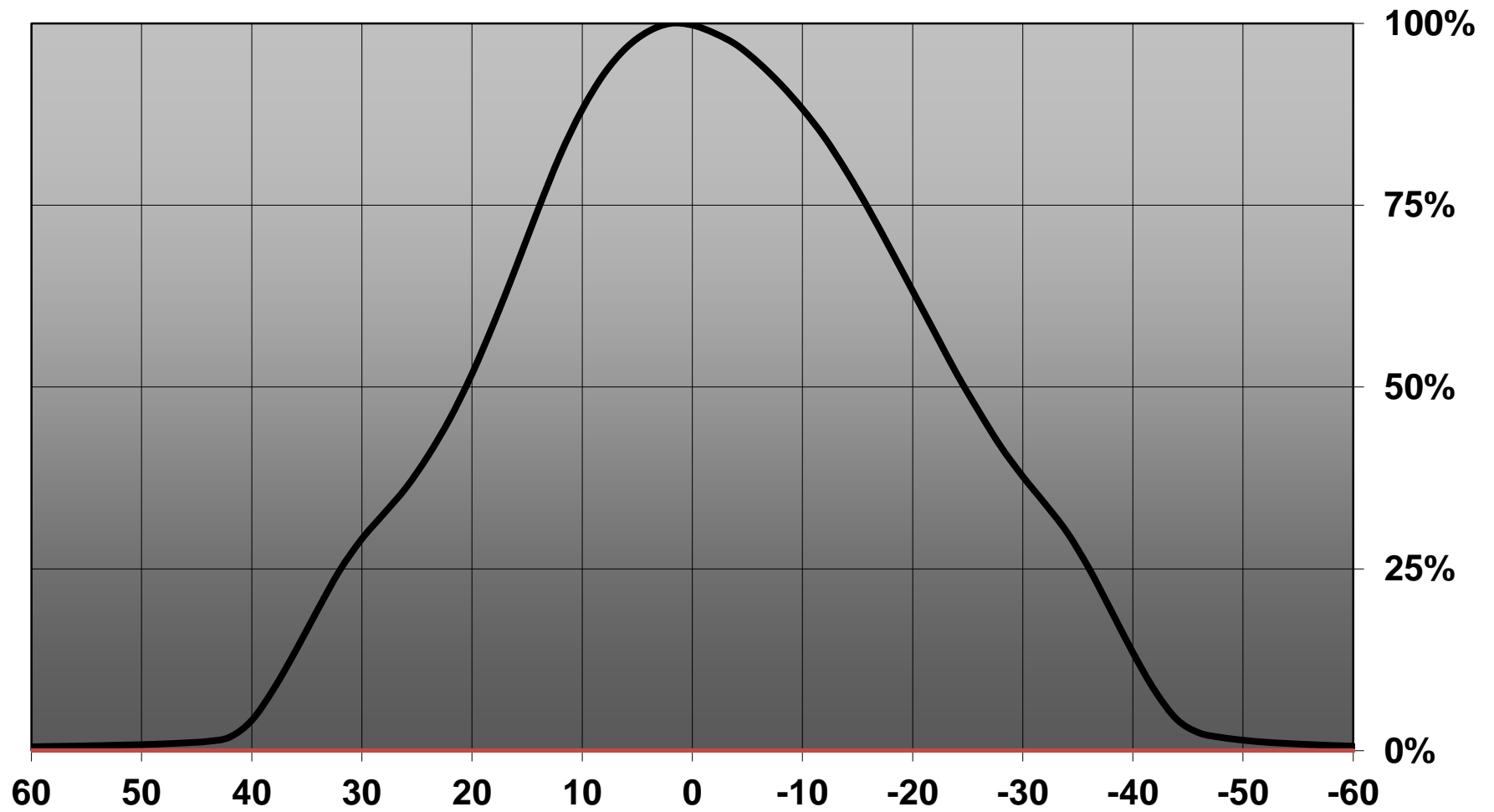

Relative intensity of CN13520\_MIRELLA-50-W-CL\_(CXA1304)

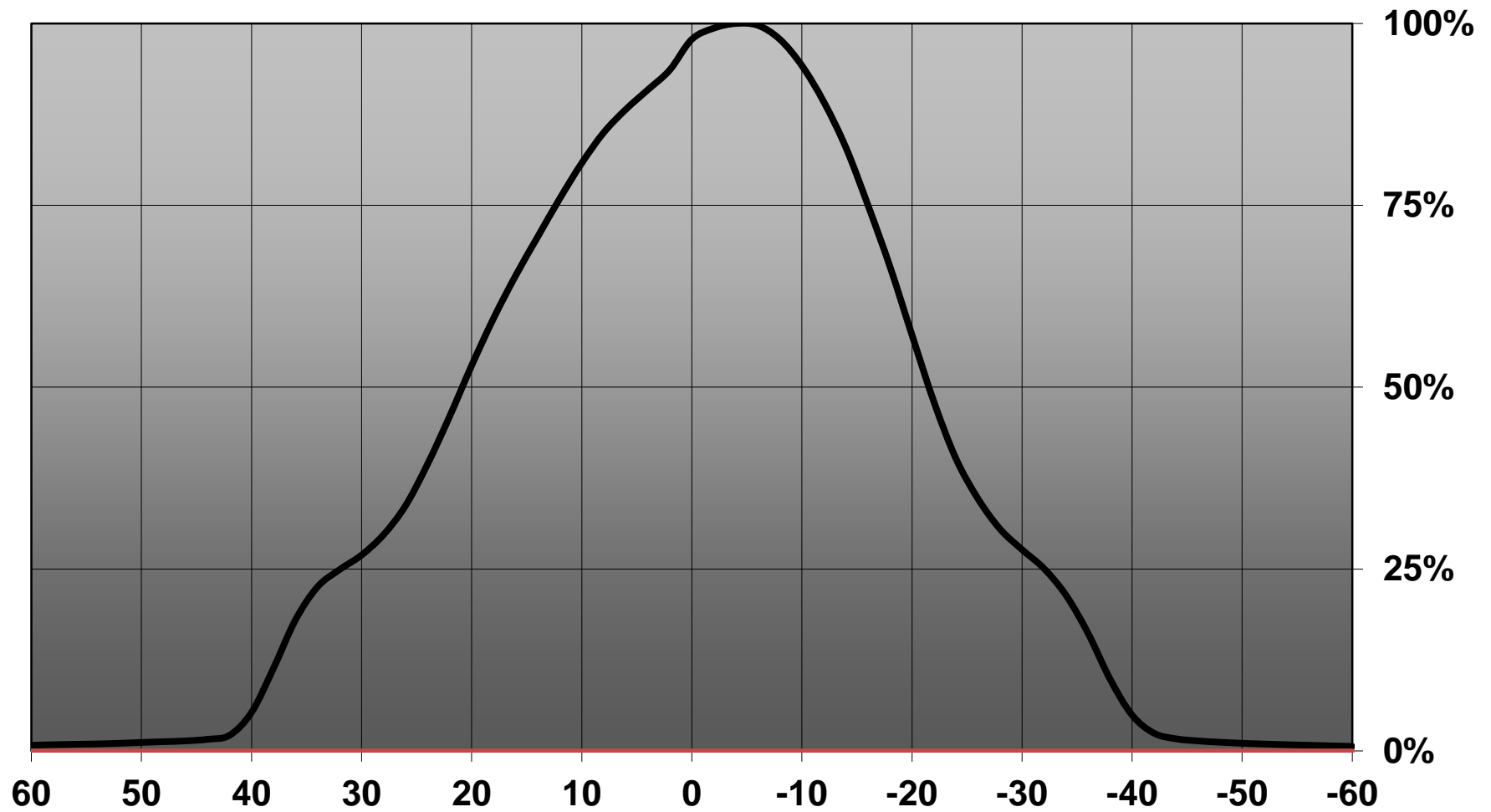

Relative intensity of CN13520\_MIRELLA-50-W-CL\_(CXA1816)

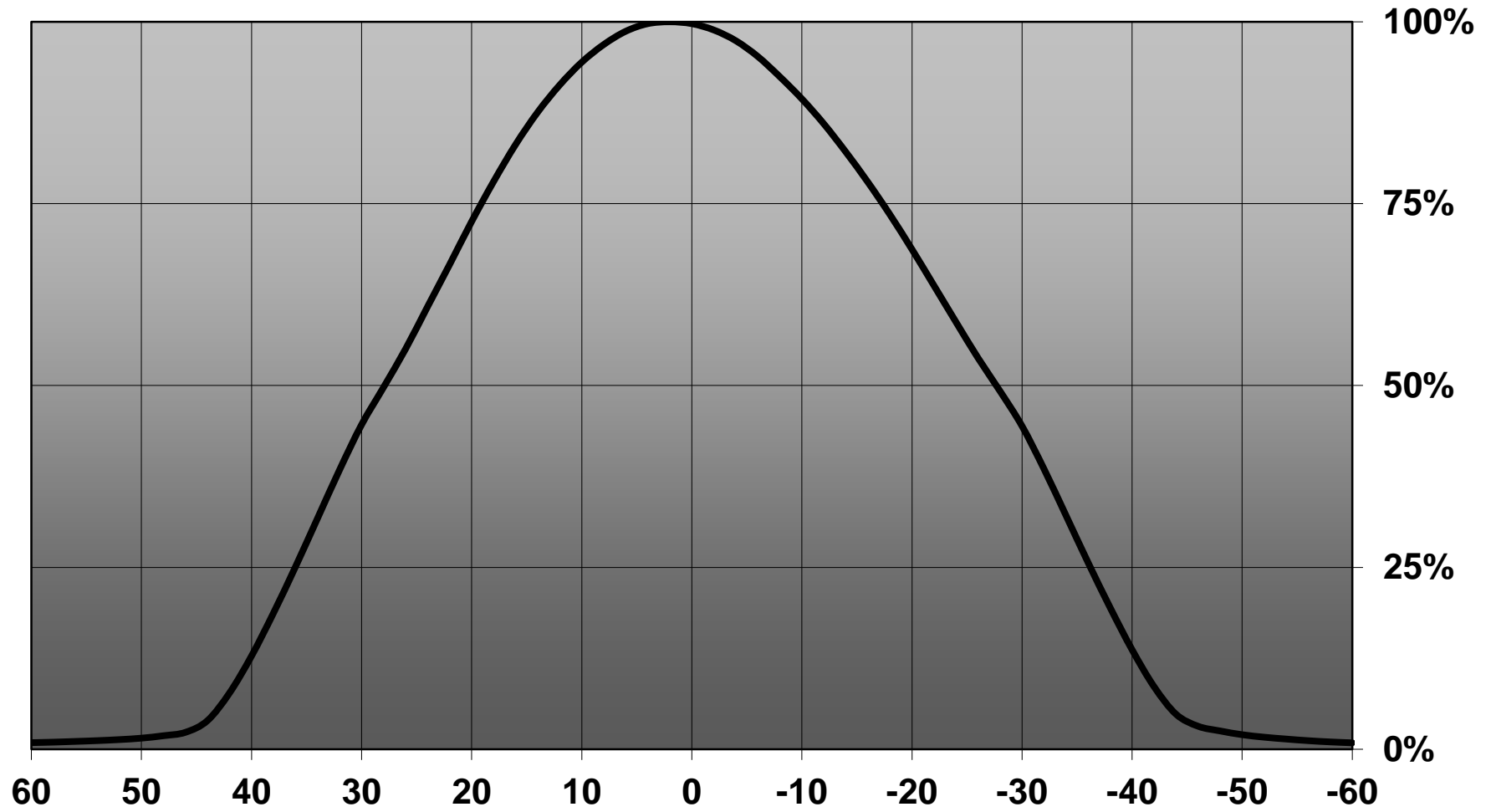



Relative intensity of CN13520\_MIRELLA-50-W-CL-(COB-4W)

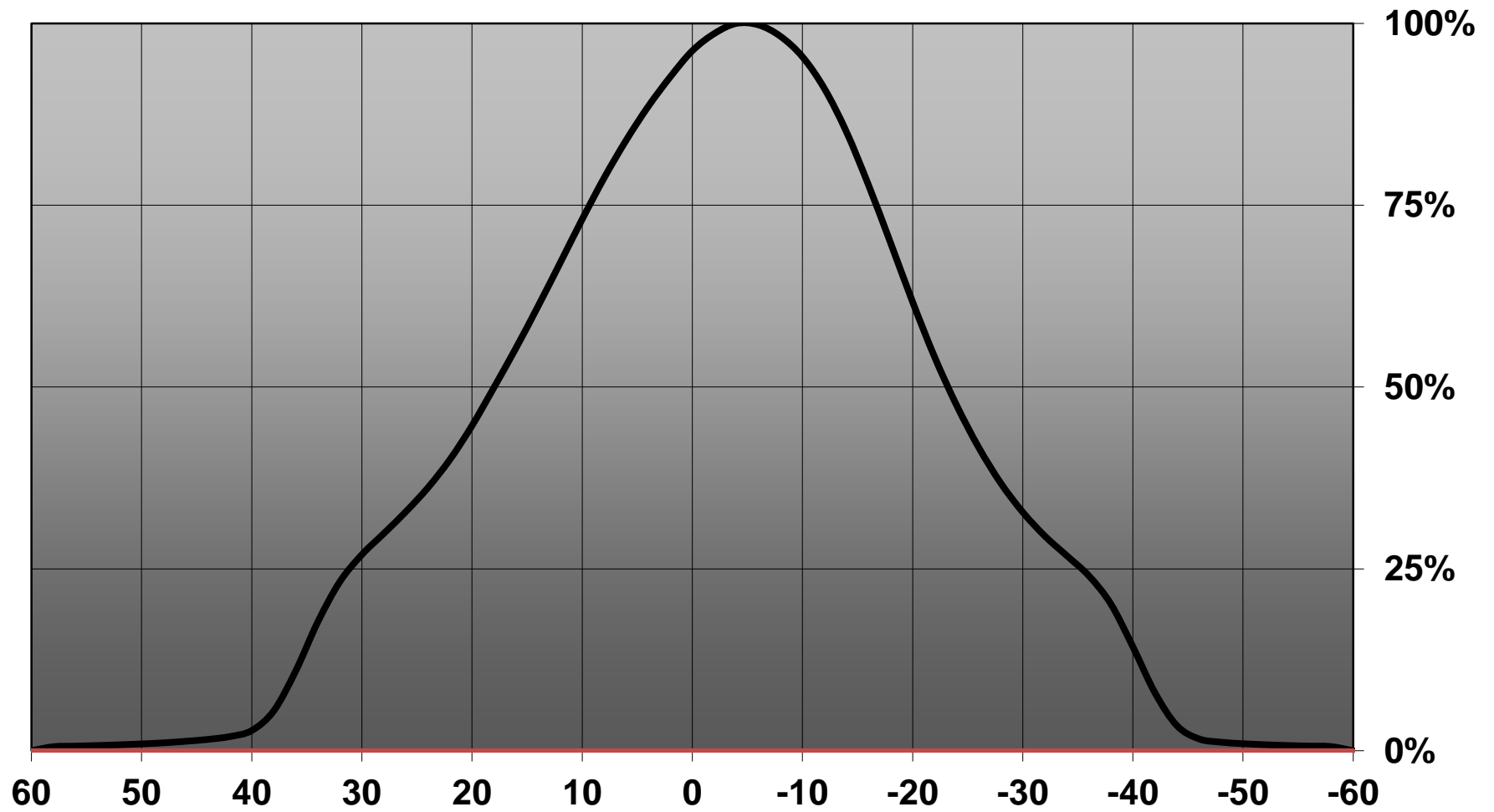

Relative intensity of CN13520\_MIRELLA-50-W-CL-(LuxS)

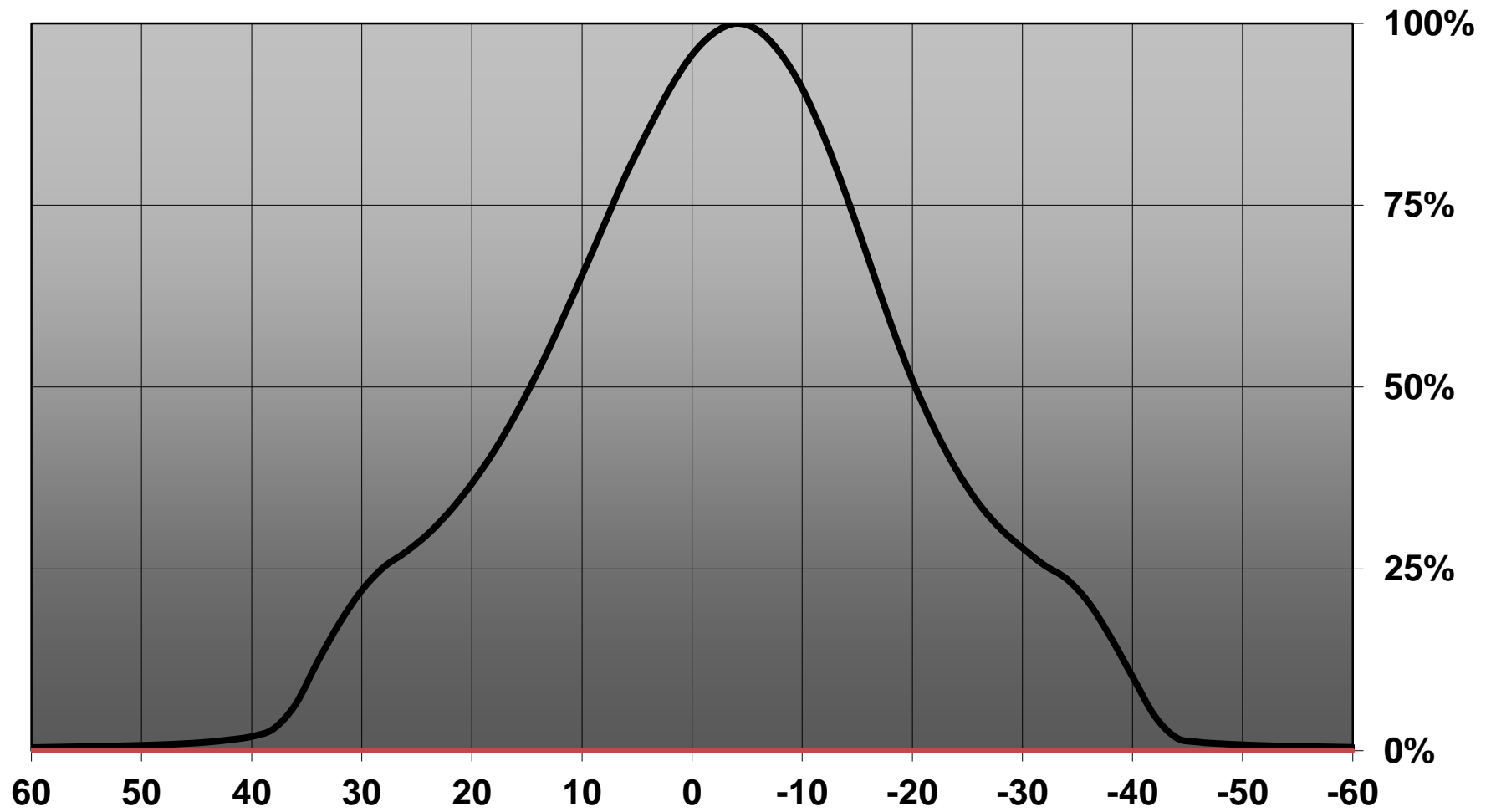

Relative intensity of CN13520\_MIRELLA-50-W-CL\_(Duris\_S10)

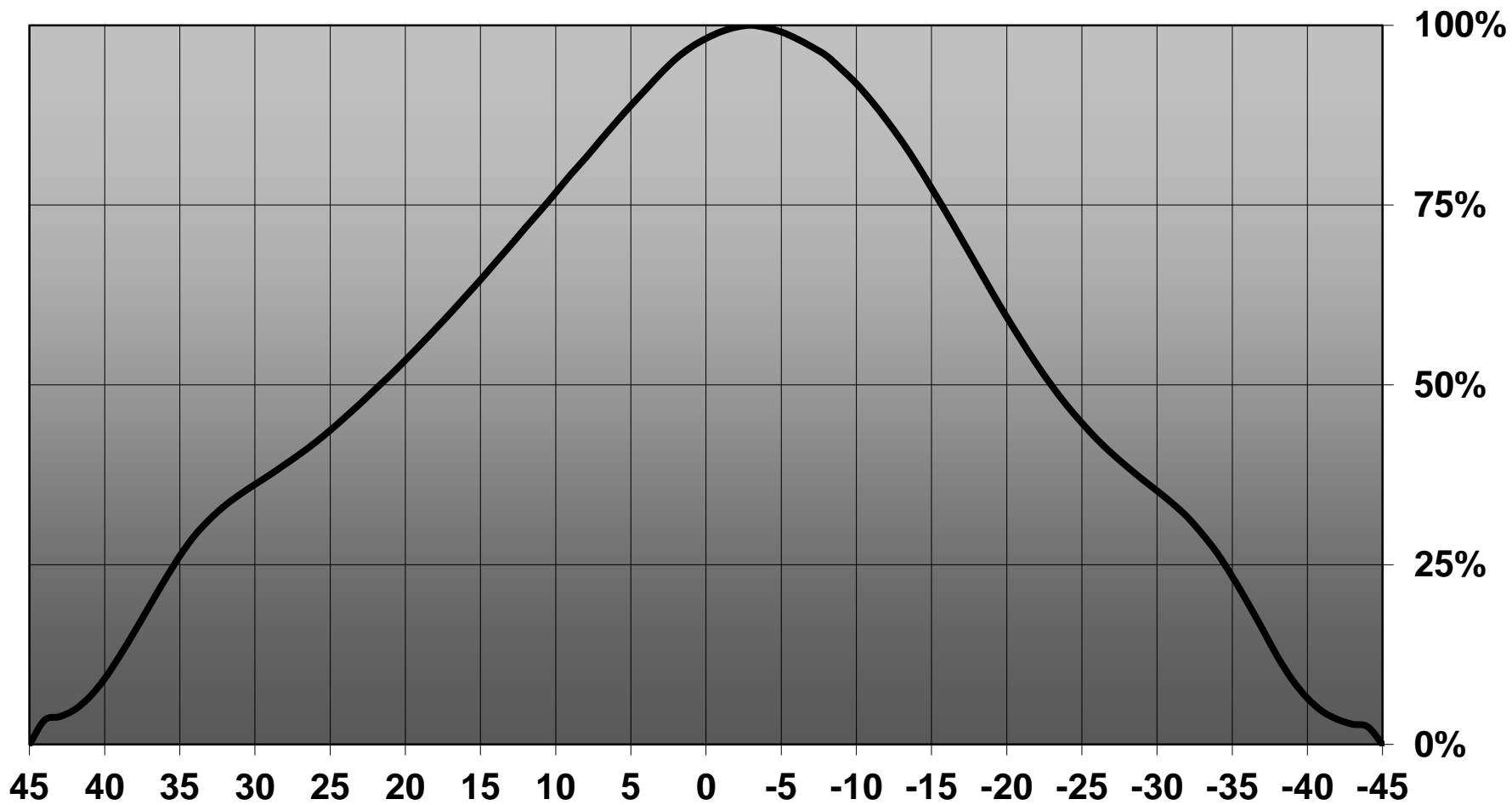

H G F E D C B A

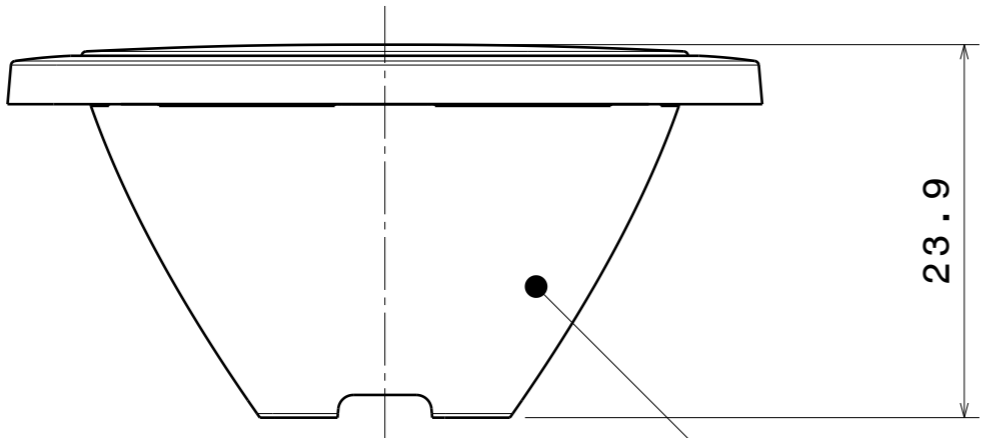

Front view

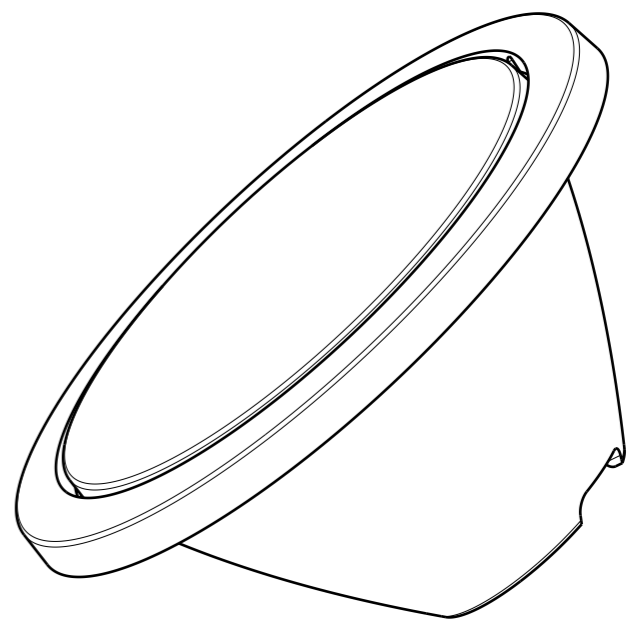

Isometric view

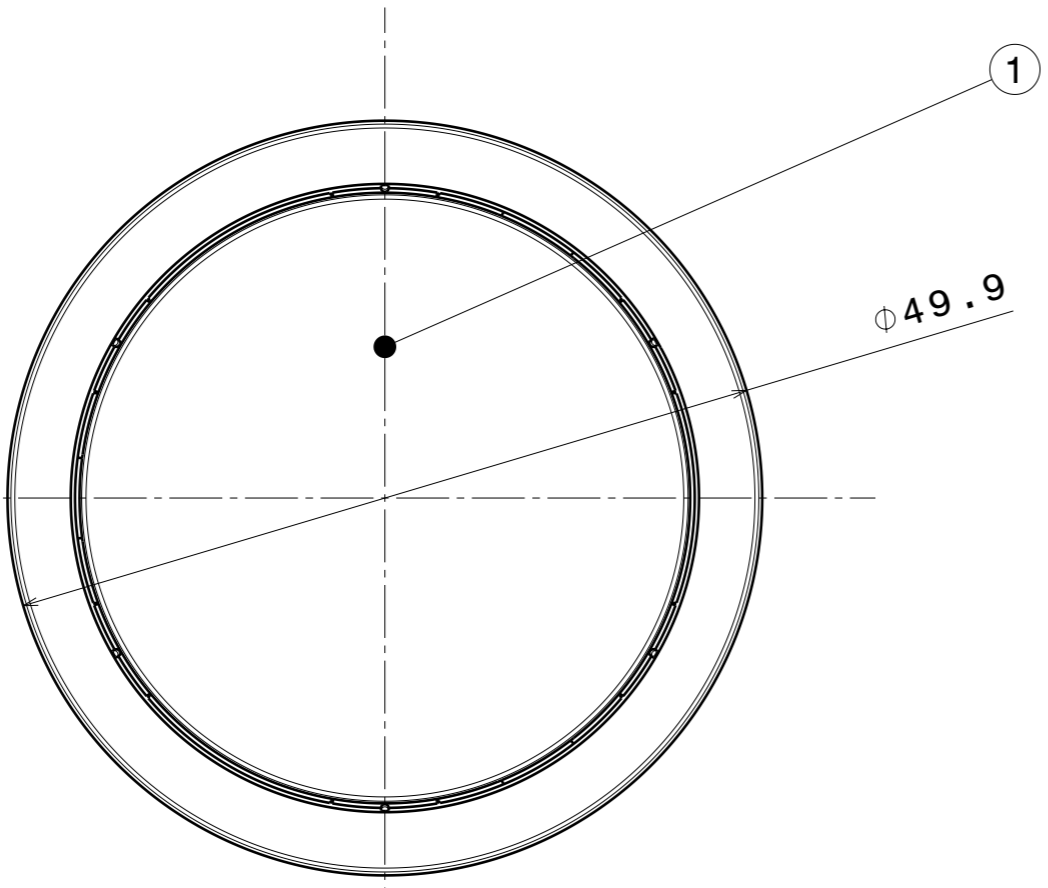

Front view

INDEX	PART NO	DESCRIPTION	MATERIAL
1	C13333	MIRELLA-CL	PC
2	C12478	MIRELLA-50-W	PC

Tolerances if not otherwise shown  
 According to DIN ISO 2768-1  
 Linear measures:  
 Up to 30mm class M, otherwise class C.  
 According to DIN ISO 2768-2  
 Form and position: class L

**LEDiL** Ledil Oy  
 Salorankatu 10  
 FIN 24240 SALO  
 Finland

THIRD ANGLE PROJECTION:

DRAWING TITLE  
**CN13520\_MIRELLA-50-W-CL**

This drawing is the property  
 of LEDiL Oy. It may not be  
 reproduced, copied or  
 communicated without a written  
 agreement with LEDiL Oy."

SIZE	PART NUMBER
<b>A3</b>	<b>CN13520</b>

SCALE	2:1	WEIGHT	(g)	SHEET	1/1
-------	-----	--------	-----	-------	-----

H G B A

# Ledil CN13520\_MIRELLA-50-W-CL\_(CLU720) / LDC (Linear)

Luminaire: Ledil CN13520\_MIRELLA-50-W-CL\_(CLU720)  
Lamps: 1 x CITIZEN\_CLU720\_(CLU720-1206B8-273M2)  
\_1298.17lm@250mA\_CCT=2700K\_P=8.3W\_I=0.25A

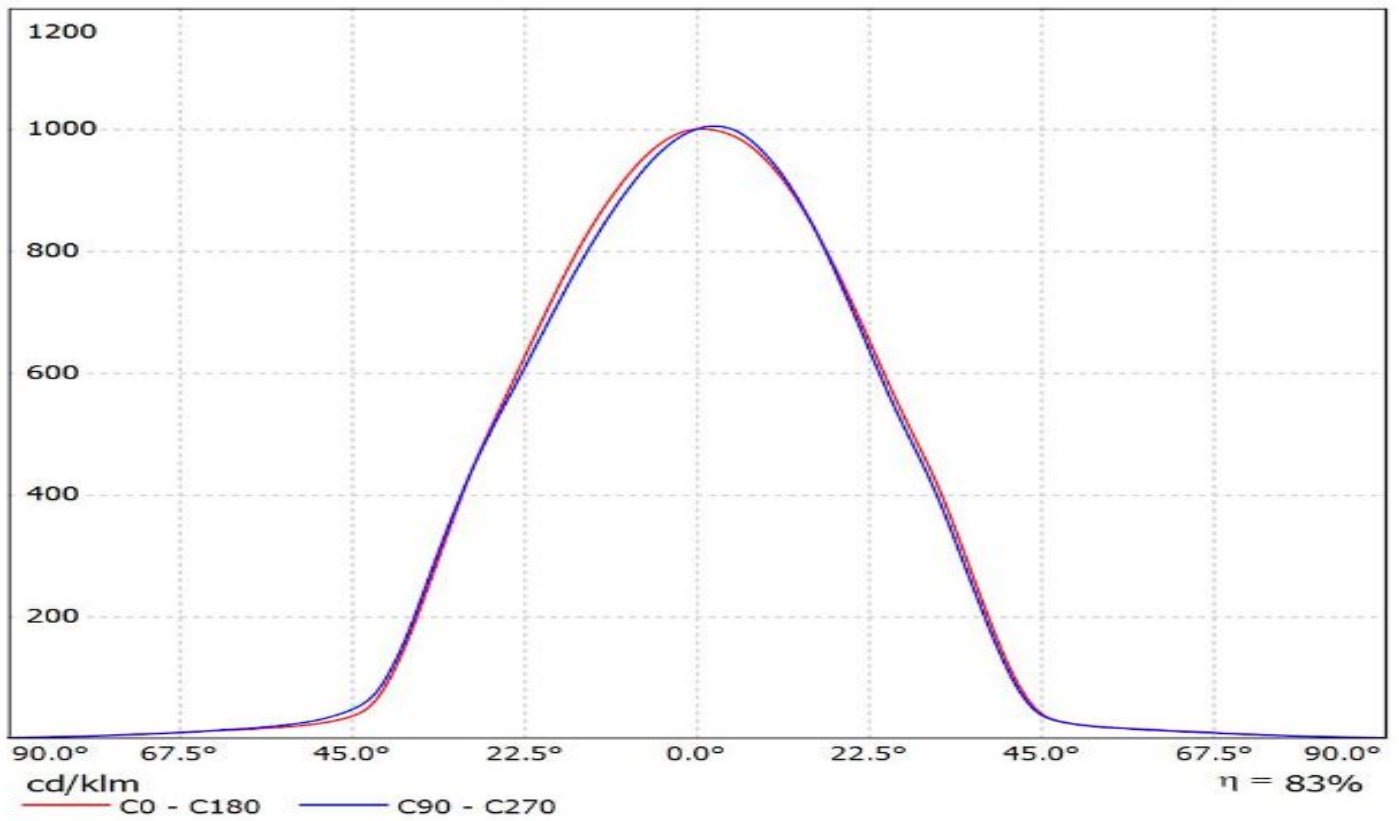

Luminaire: Ledil CN13520\_MIRELLA-50-W-CL\_(CLU710)

Lamps: 1 x CITIZEN\_CLU710\_(CLU710-1204B8-273M2G1)\_1212.66lm@250mA\_P=8.5W\_I=0.25A

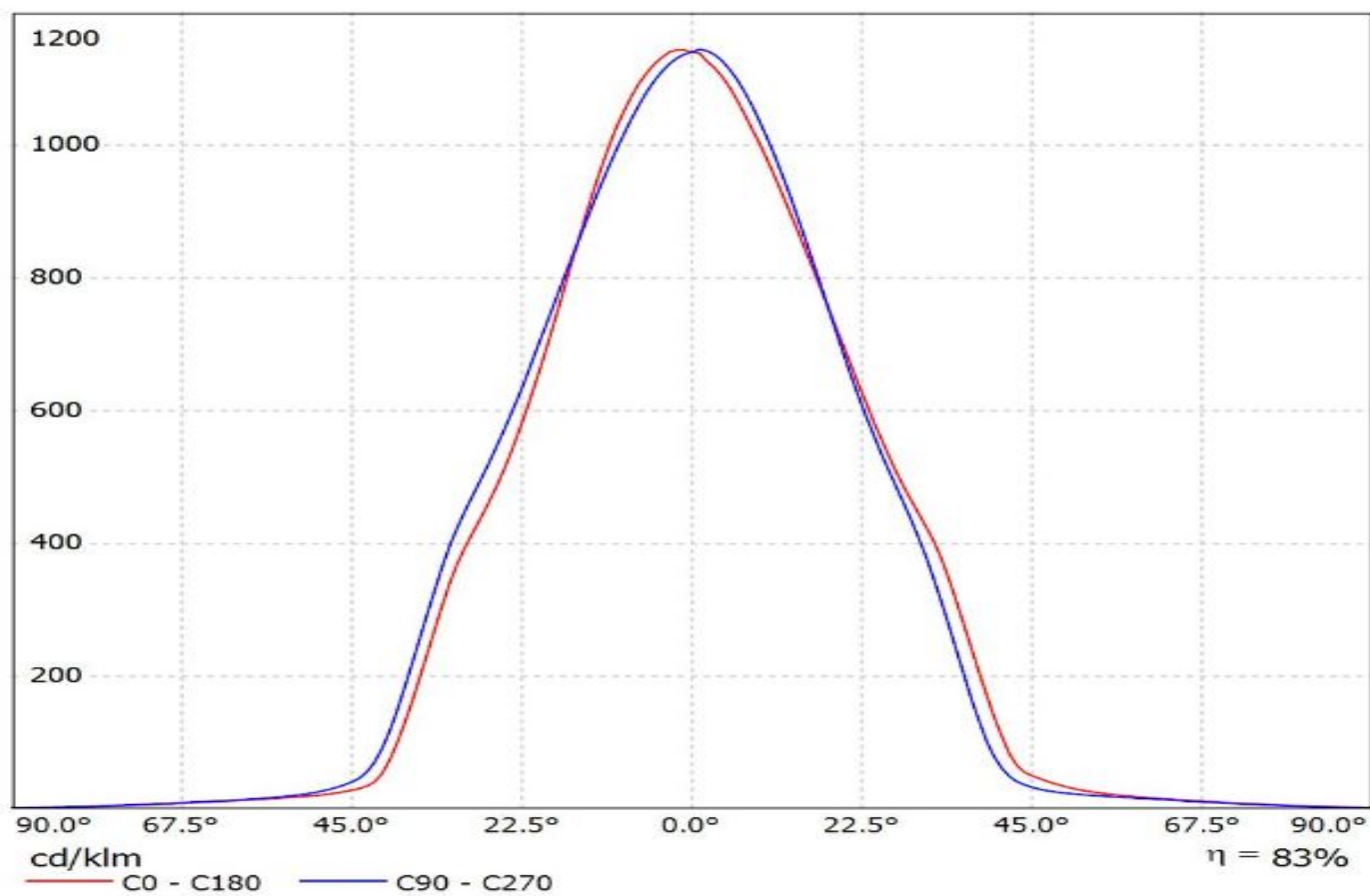

Luminaire: Ledil CN13520\_MIRELLA-50-W-CL\_(CLU700)  
Lamps: 1 x Citizen\_CLU700\_395.592lm@100mA\_P=2.815W\_I=0.1A

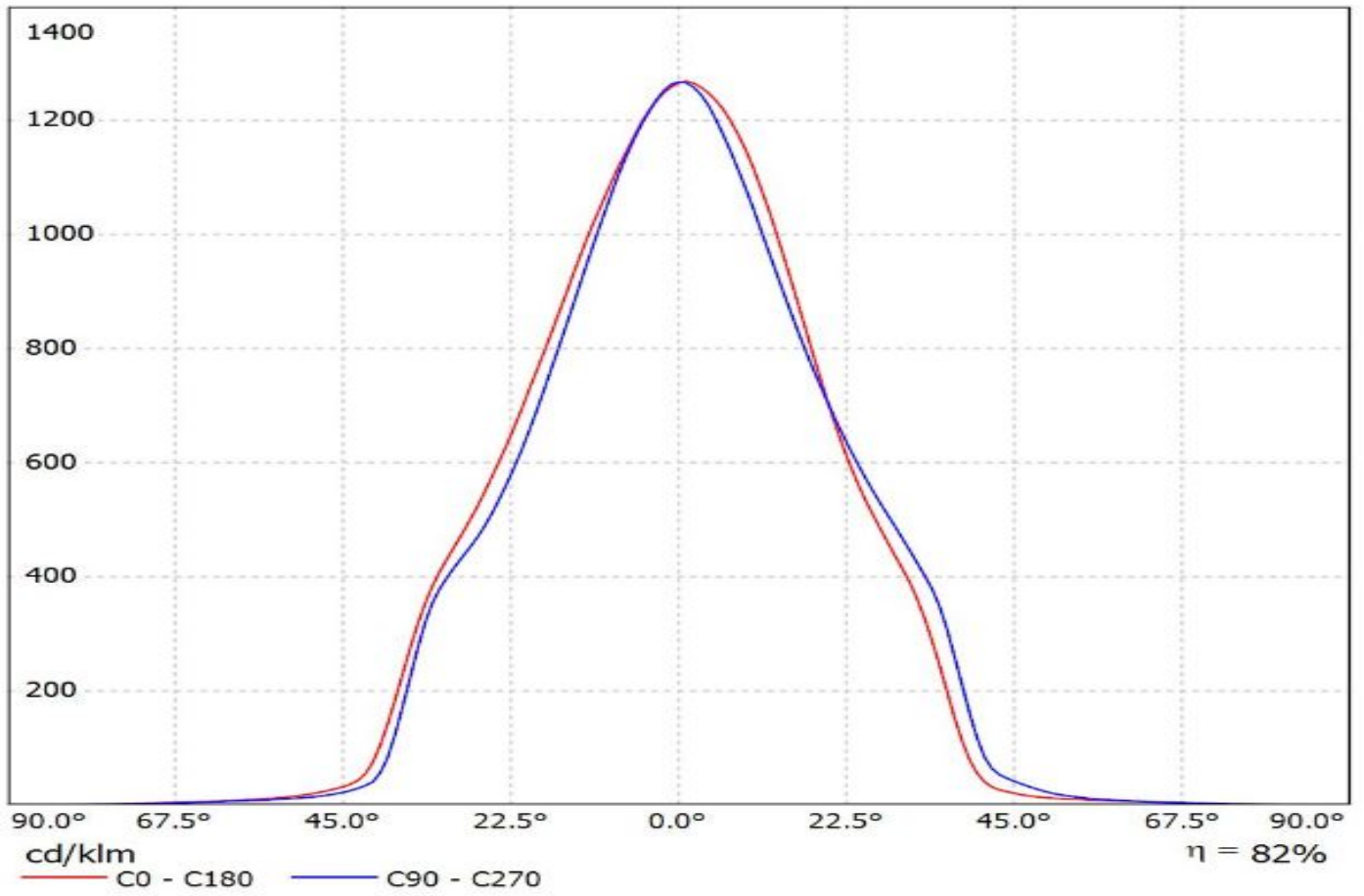

Luminaire: LEDiL Oy CN13520\_MIRELLA-50-W-CL\_(CREE\_XHP50\_WARM\_WHITE)  
Lamps: 1 x CREE\_XHP50\_WARM\_WHITE\_194.925lm@250mA\_P=1.39897W\_I=0.2499A

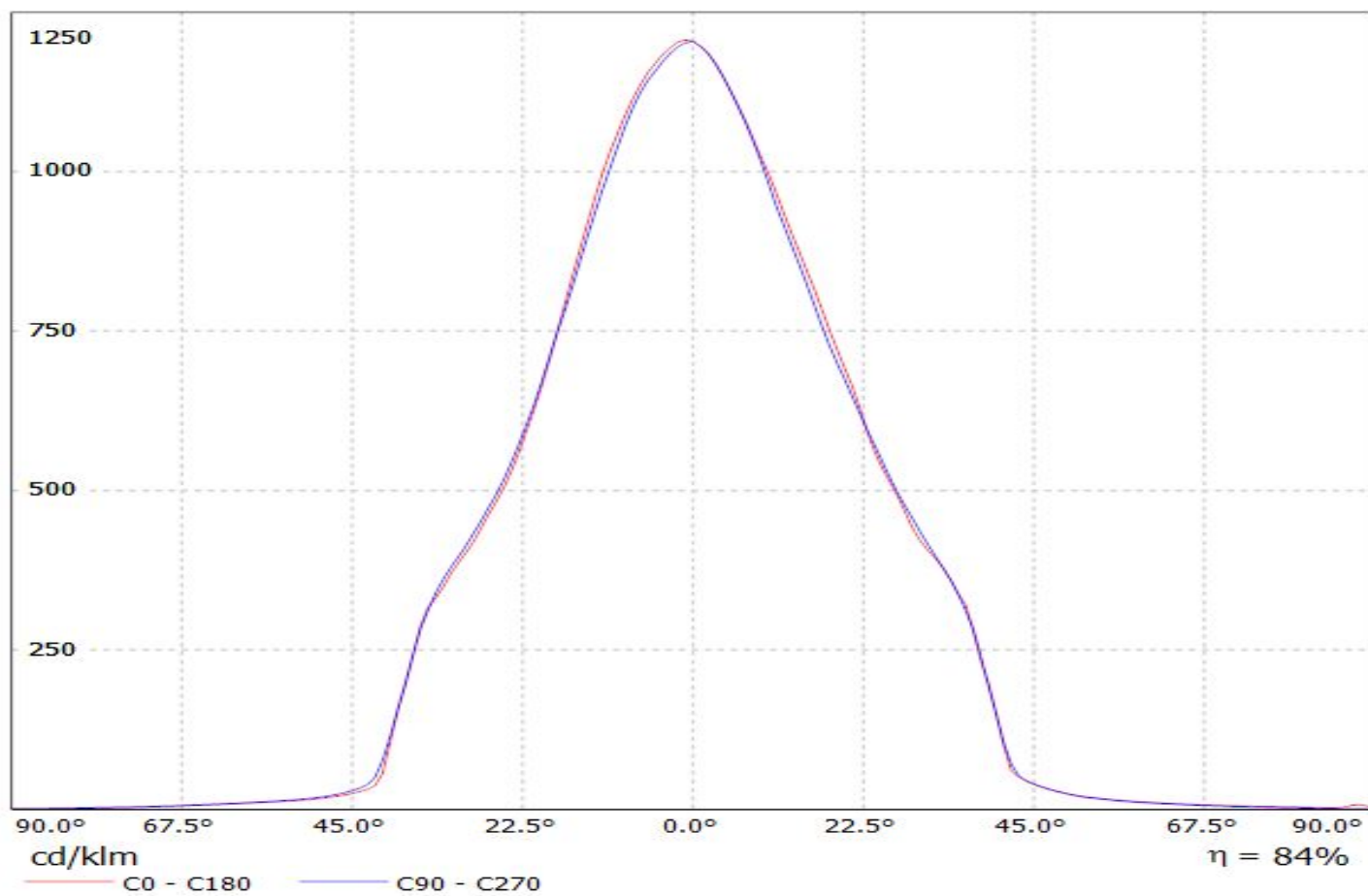



Luminaire: LEDiL Oy CN13520\_MIRELLA-50-W-CL\_(Cree\_XHP70)  
Lamps: 1 x Cree\_XHP70\_258.083lm@250mA\_P=1.38117W\_I=0.2499A

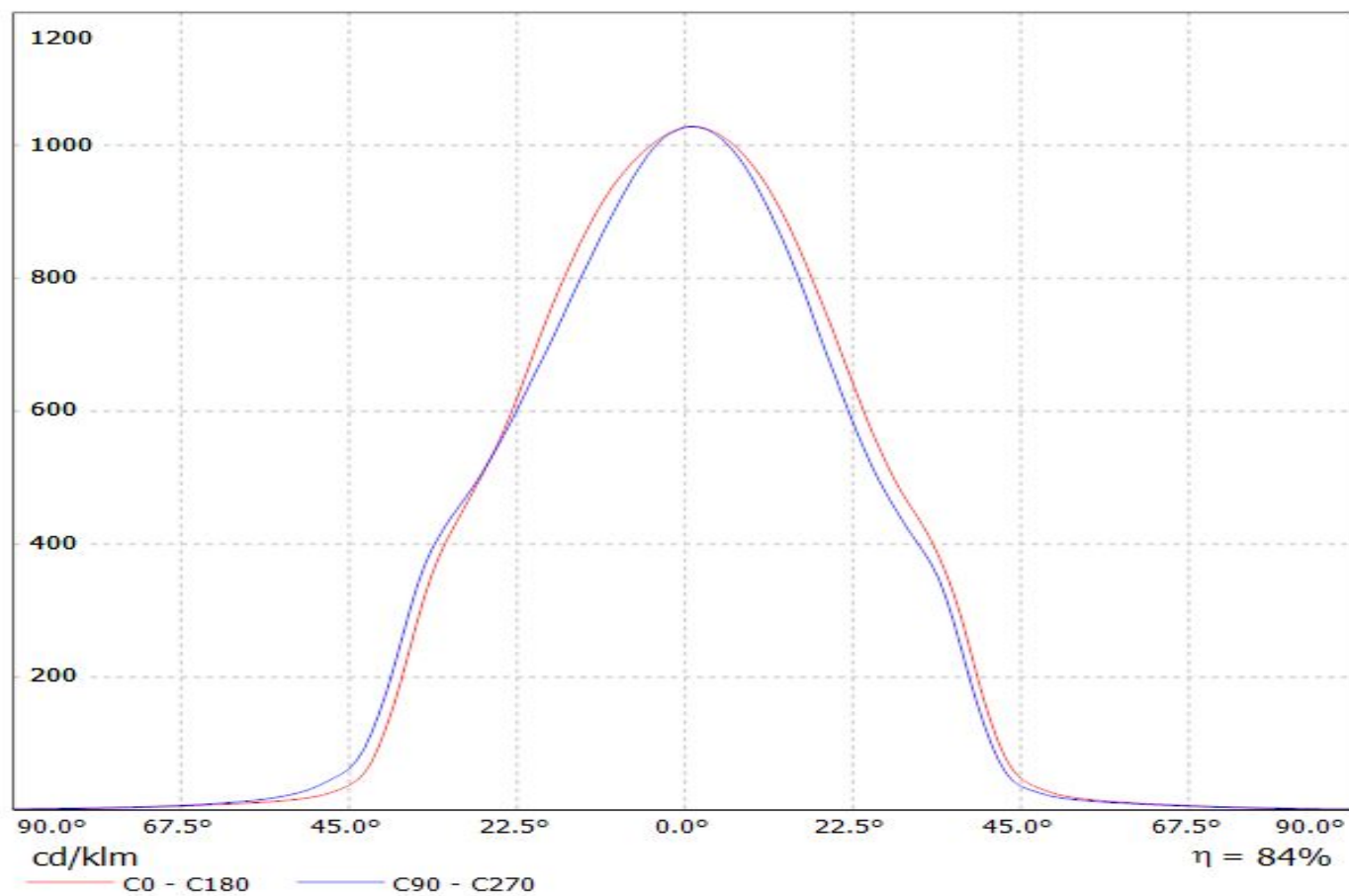

Luminaire: Ledil CN13520\_MIRELLA-50-W-CL\_(MHD-G)  
Lamps: 1 x Cree MHD-G\_528.649lm@100mA\_P=3.0W\_I=0.100A

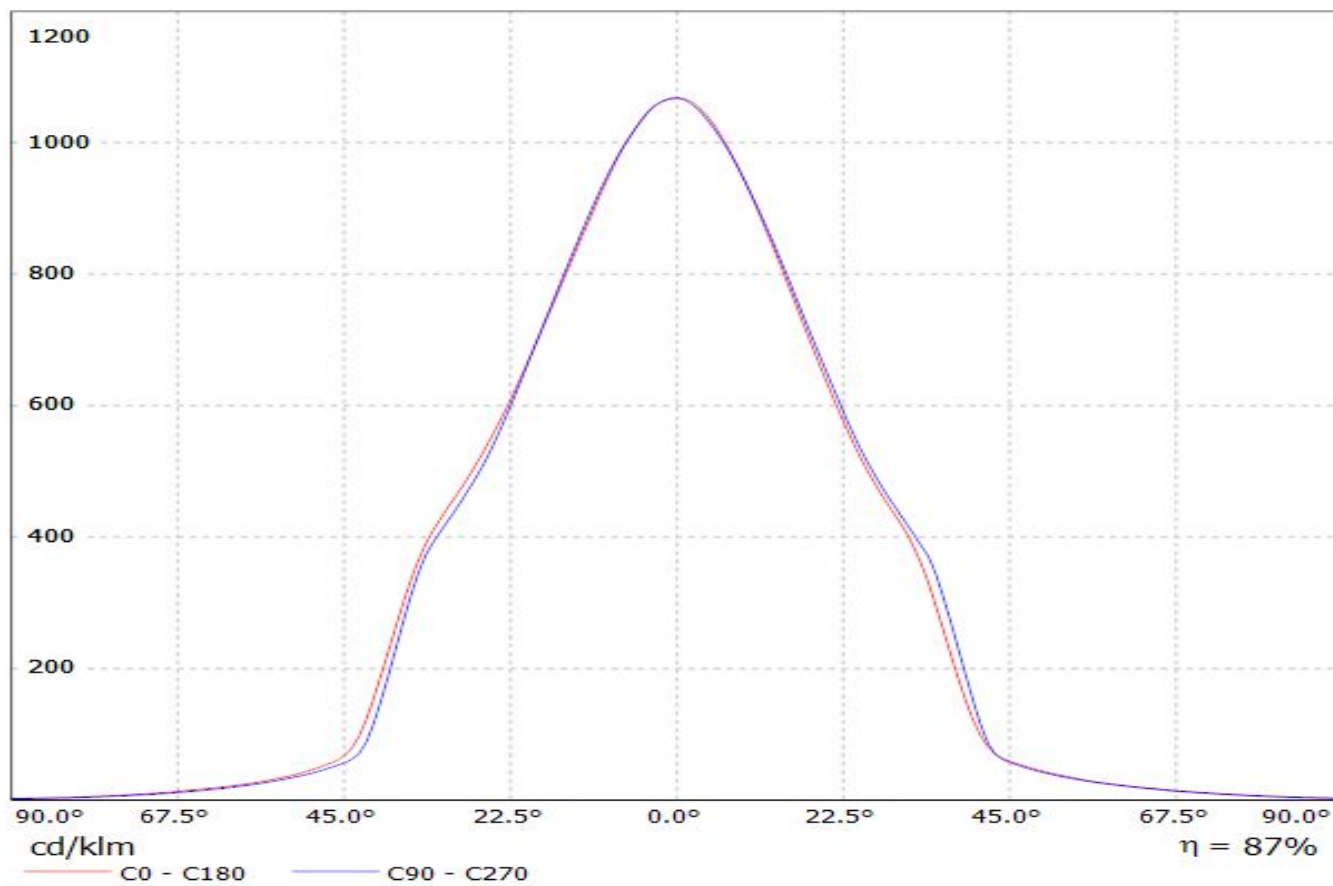

Luminaire: Ledil Oy CN13520\_MIRELLA-50-W-CL (Luxeon\_CoB\_1203) Efficiency=86%  
Lamps: 1 x Luxeon Cob 1203 (LHC1-3080-1203) 824lm @ 250mA CCT=3000K P=8.7W I=250mA

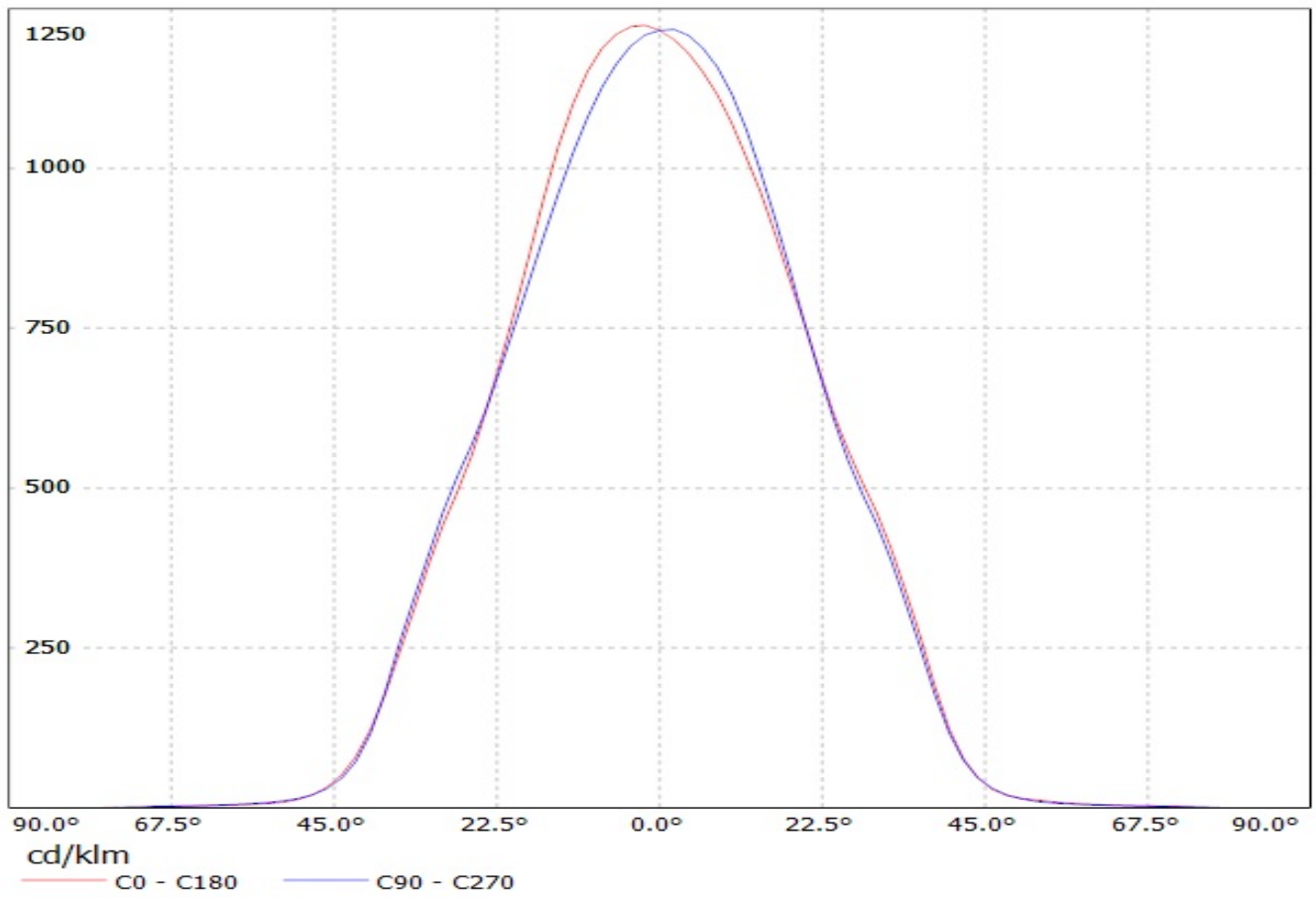

Luminaire: LEDiL Oy CN13520\_MIRELLA-50-W-CL\_(CXM-9)

Lamps: 1 x Luminus\_XNOVA\_CXM-9\_(AA00)\_974.297lm@240mA\_P=8.2836W\_I=240mA

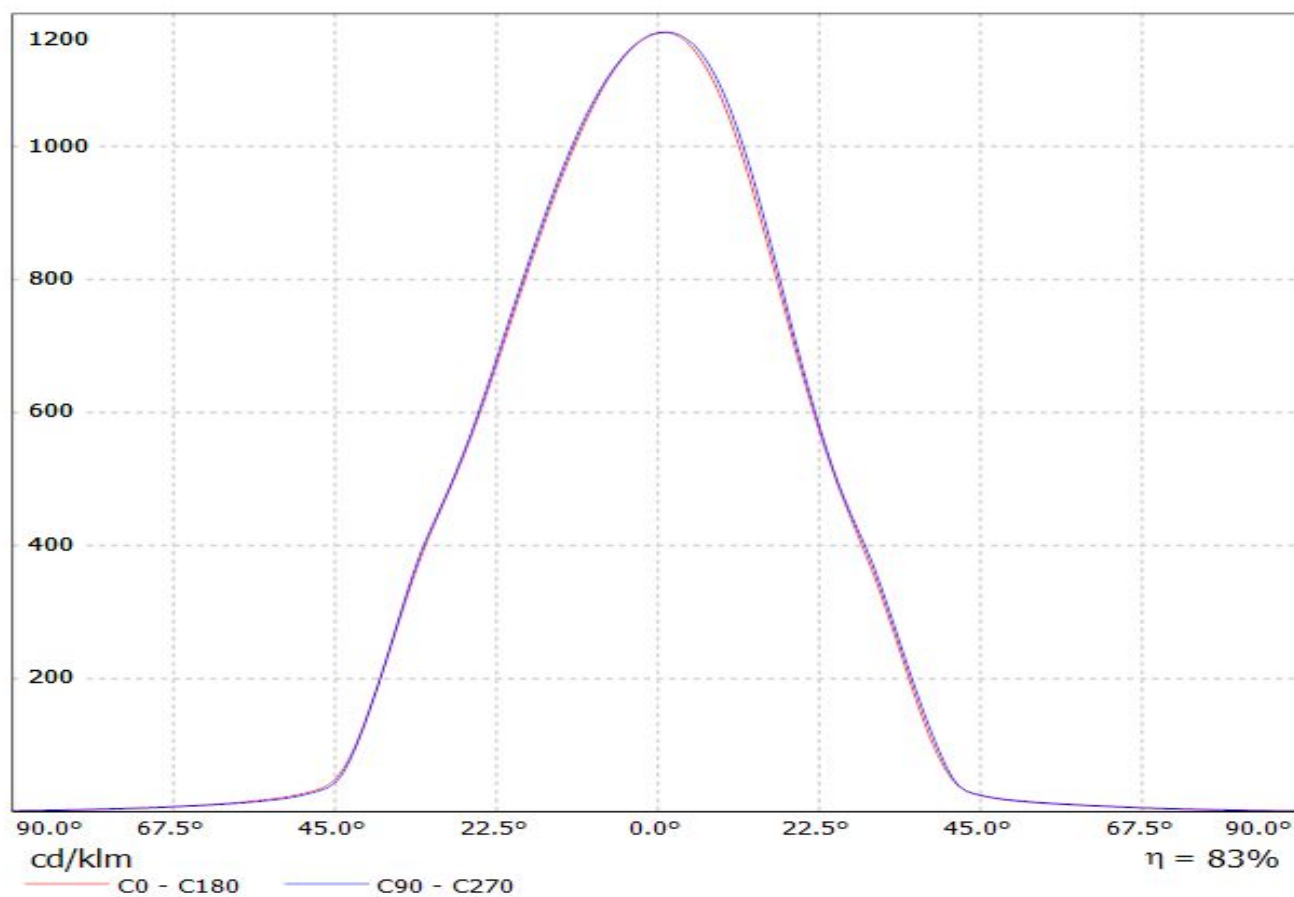

Luminaire: Ledil Oy CN13520\_MIRELLA-50-W-CL (NSBxL066A 930lm @ 250mA) Efficiency=85%  
Lamps: 1 x NSBxL066A 930lm @ 250mA (NSBLL066AE) CCT=3536K P=7,75W I=250mA

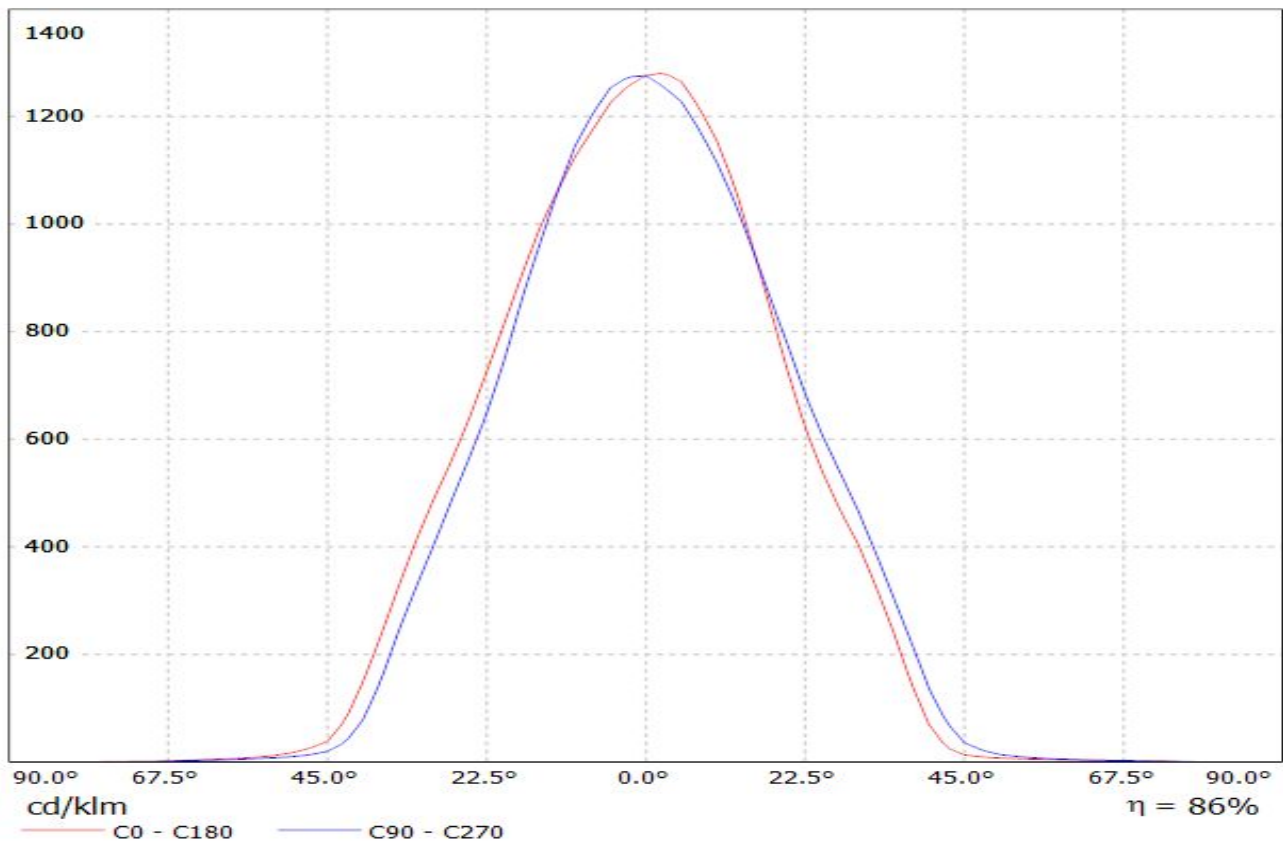

Luminaire: Ledil Oy CN13520\_MIRELLA-50-W-CL (Nichia NSCxL036A 434lm @ 100mA) Efficiency=83%  
Lamps: 1 x Nichia NSCxL036A 434lm @ 100mA (NSCLL036A) CCT=3000K P=3,4W I=100mA

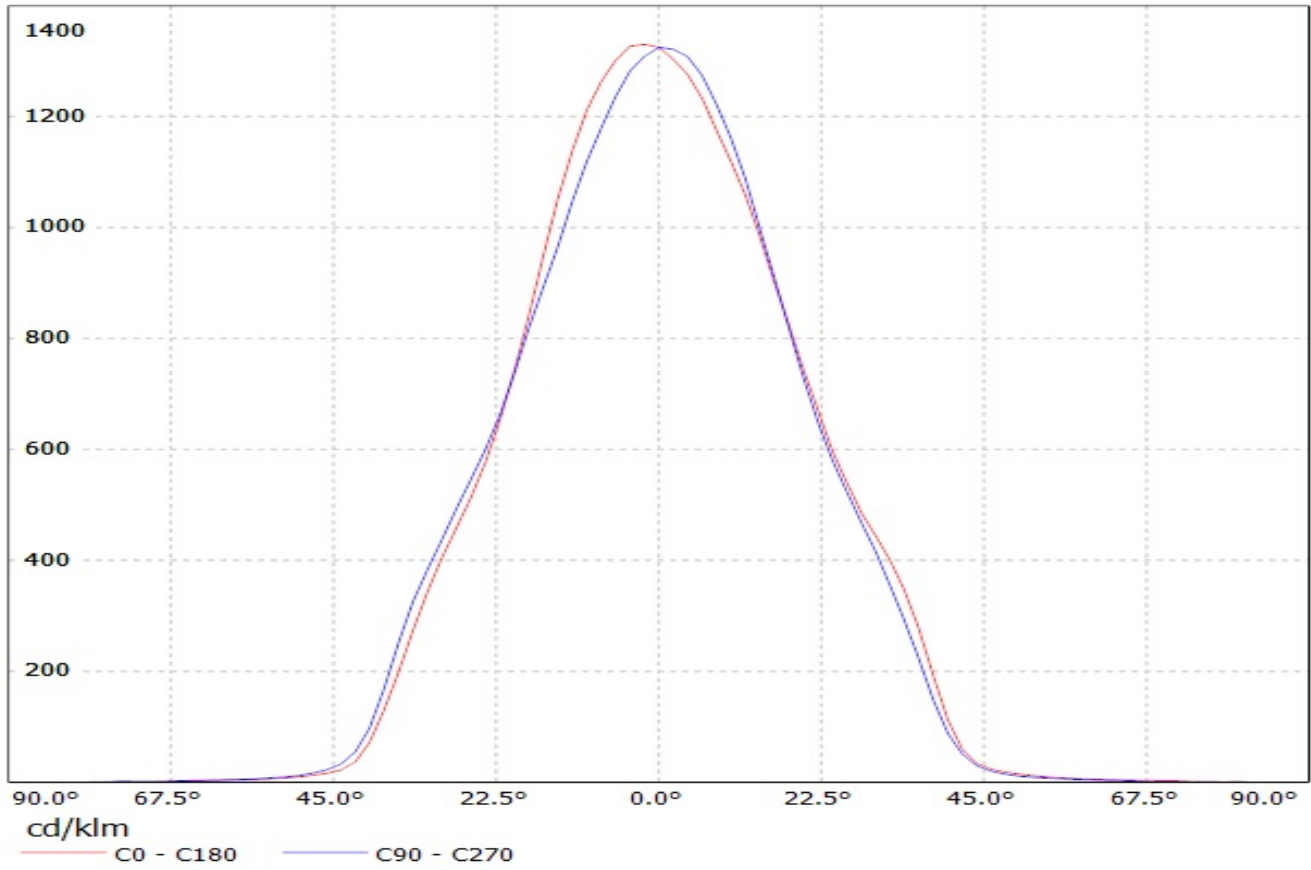

Luminaire: LEDil Oy CN13520\_MIRELLA-50-W-CL\_(Soleriq\_S13) Efficiency=80%  
Lamps: 1 x Osram Soleriq S13 (GW KAGHB1.EM) 832lm @ 250mA CCT=3100K P=7.4W I=250mA

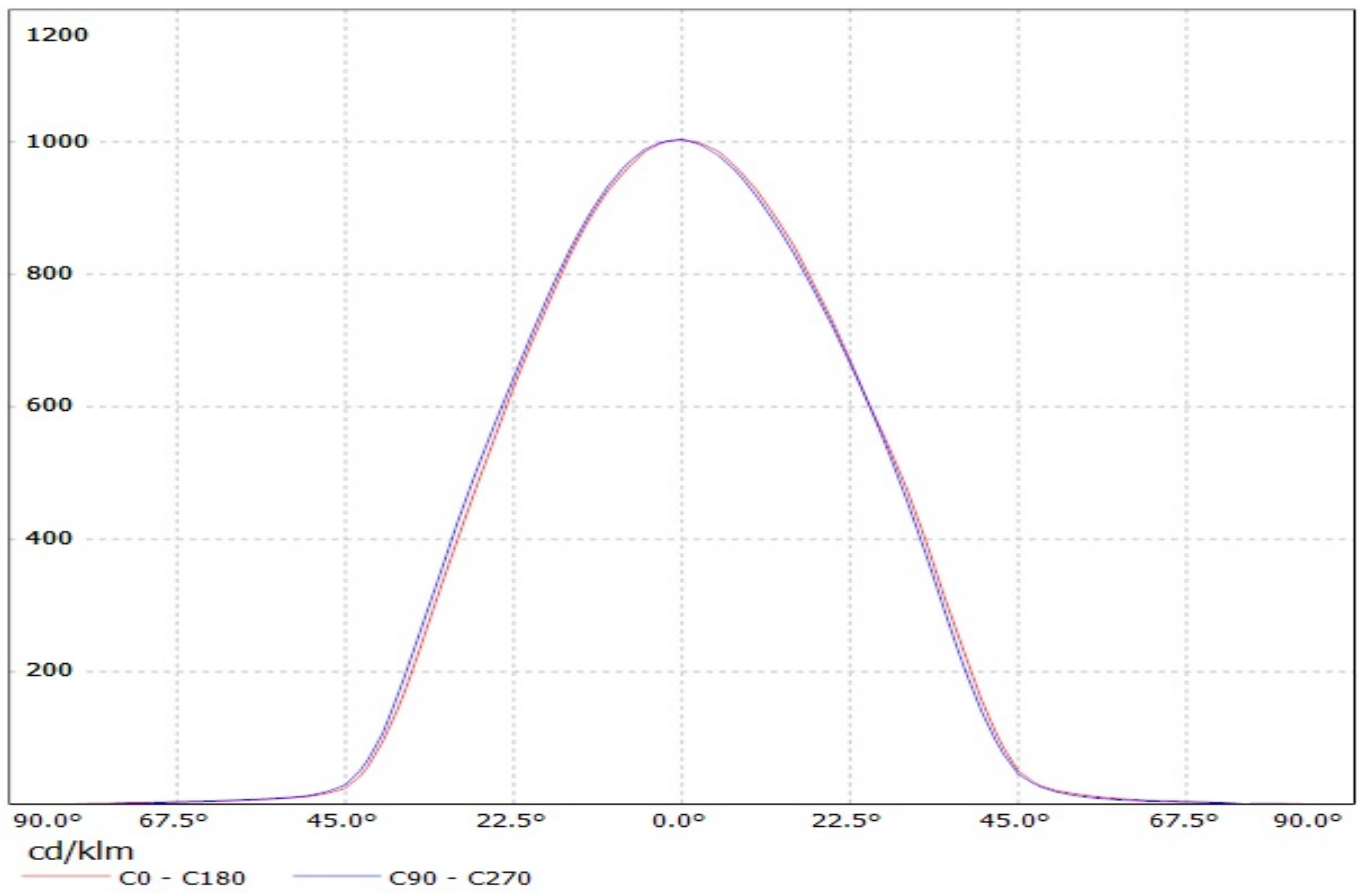

Luminaire: Ledil Oy CN13520\_MIRELLA-50-W-CL\_(Soleriq\_S9)\_SIMULATED  
Lamps: 1 x Osram Soleriq S9 (GW KAFJB3.EM)

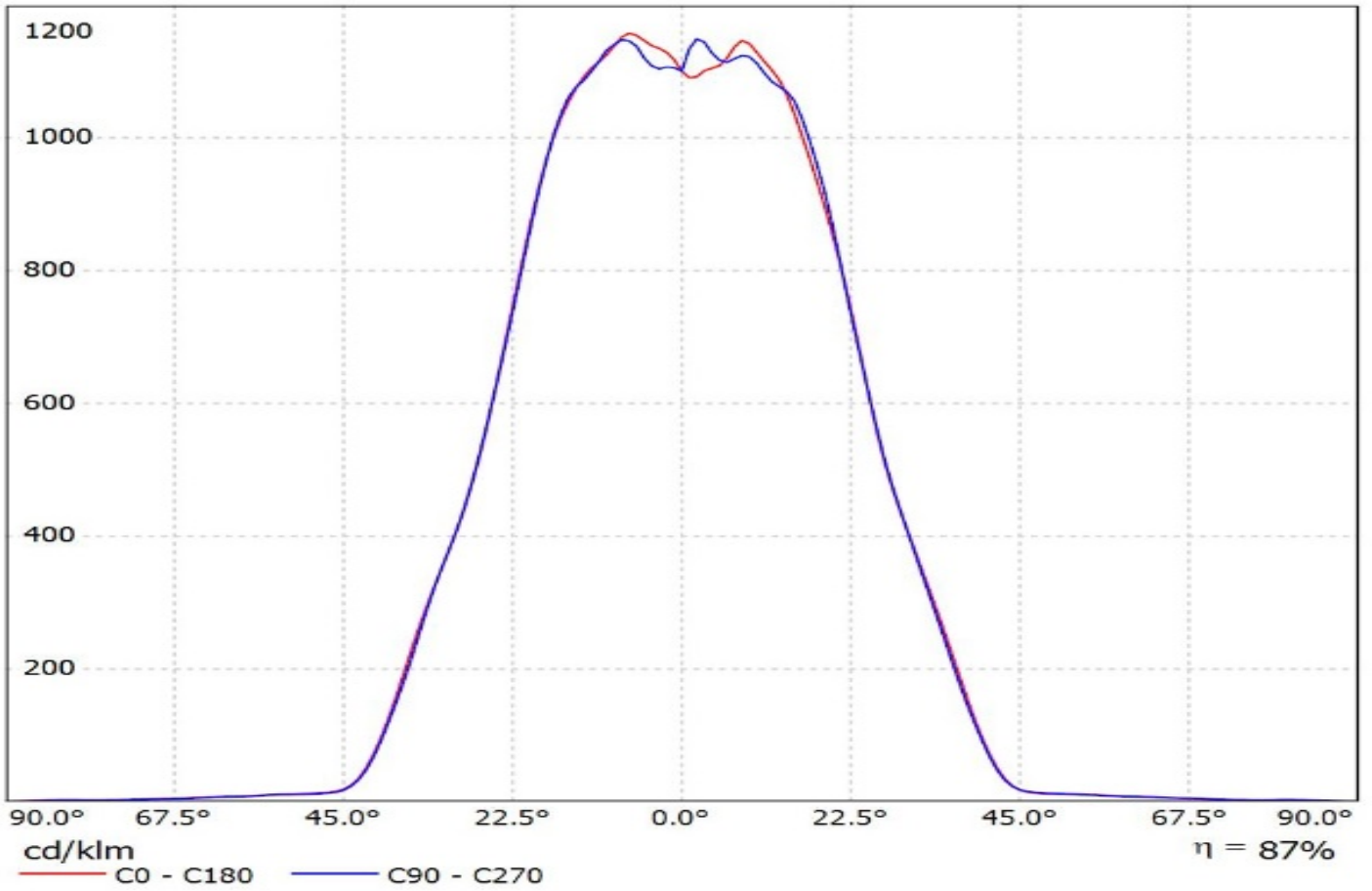



Luminaire: LEDil Oy CN13520\_MIRELLA-50-W-CL\_(ZC6) Efficiency=81%  
Lamps: 1 x Seoul ZC6 (SDW18F1C) 422lm @ 100mA CCT=3100K P=3.4W I=100mA

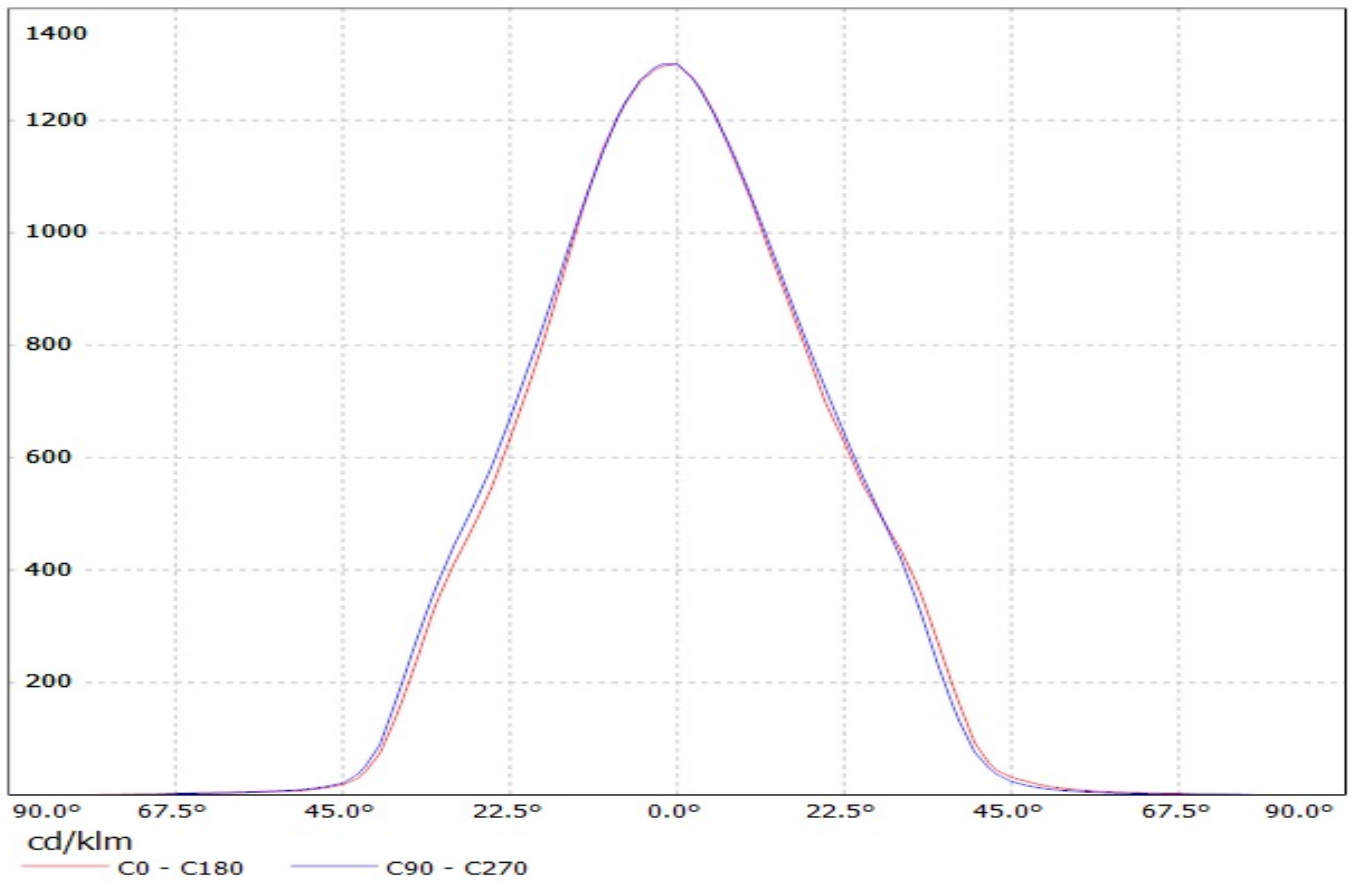

Luminaire: LEDil Oy CN13520\_MIRELLA-50-W-CL\_(Stark\_SLE\_G3\_LES10) Efficiency=81%  
Lamps: 1 x Tridonic Stark SLE G3 LES10 (STARK-SLE-PURE-G3-10-1000-830-CLA) 453lm @ 250mA CCT=3000K P=4.3W I=250mA

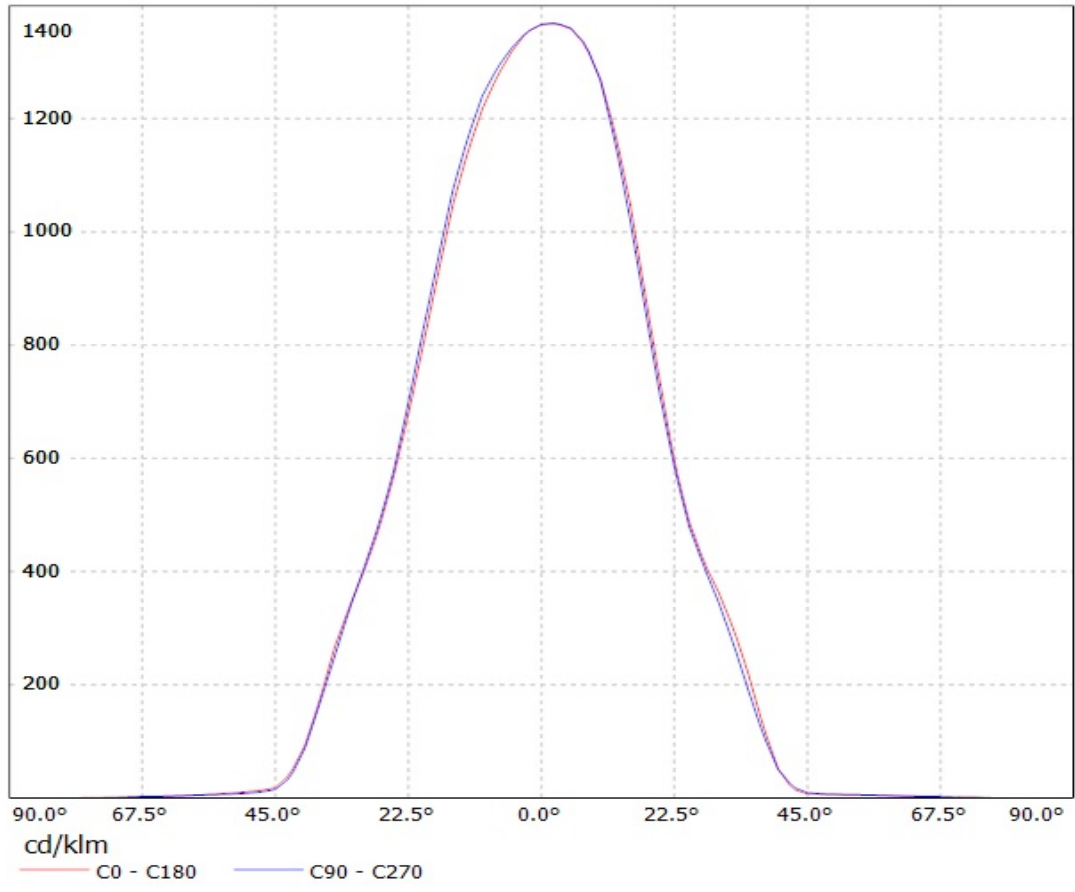

# Ledil CN13520\_MIRELLA-50-W-CL\_(CLU720) / LDC (Polar)

Luminaire: Ledil CN13520\_MIRELLA-50-W-CL\_(CLU720)  
Lamps: 1 x CITIZEN\_CLU720\_(CLU720-1206B8-273M2)  
\_1298.17lm@250mA\_CCT=2700K\_P=8.3W\_I=0.25A

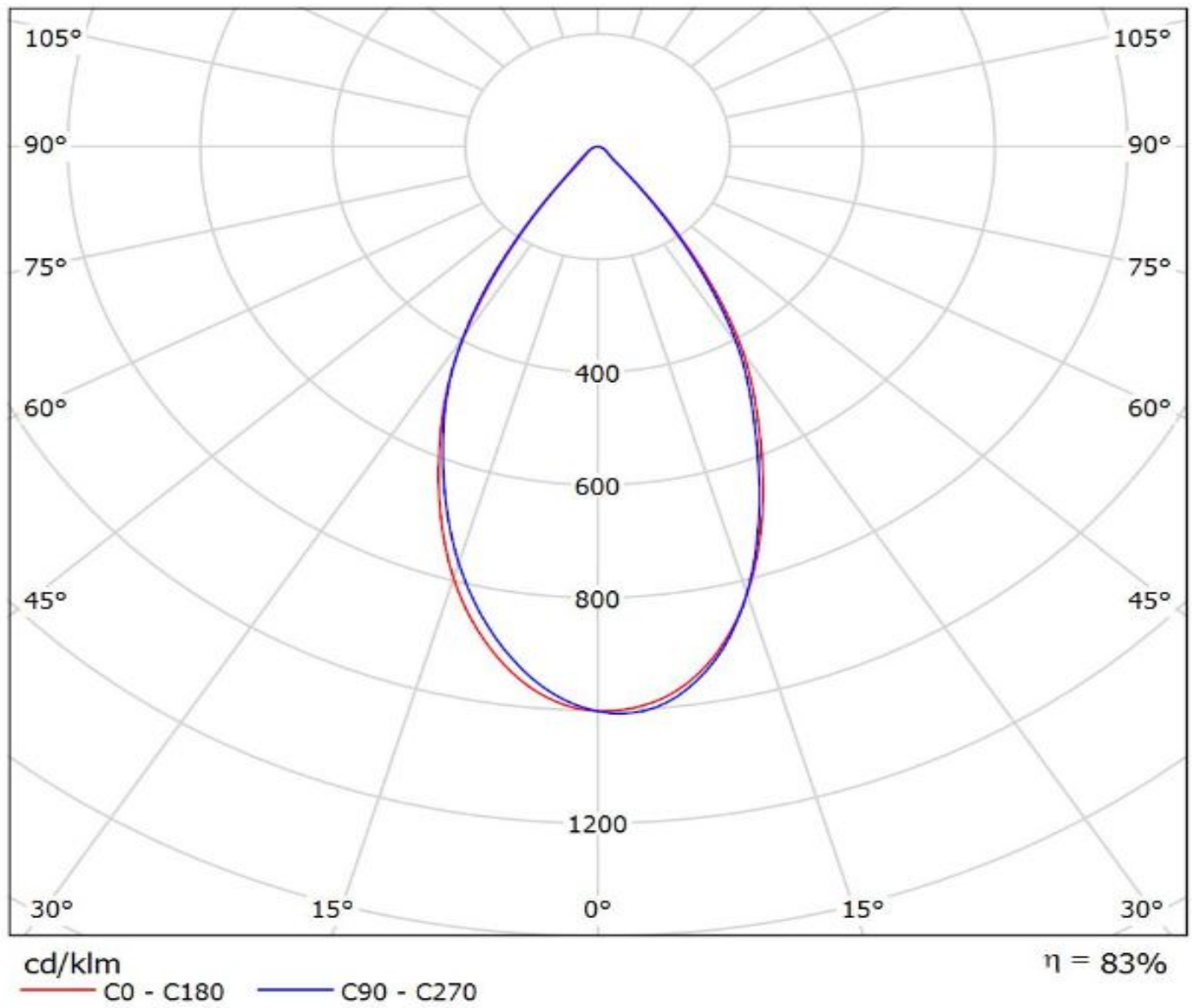

Luminaire: Ledil CN13520\_MIRELLA-50-W-CL\_(CLU710)

Lamps: 1 x CITIZEN\_CLU710\_(CLU710-1204B8-273M2G1)\_1212.66lm@250mA\_P=8.5W\_I=0.25A

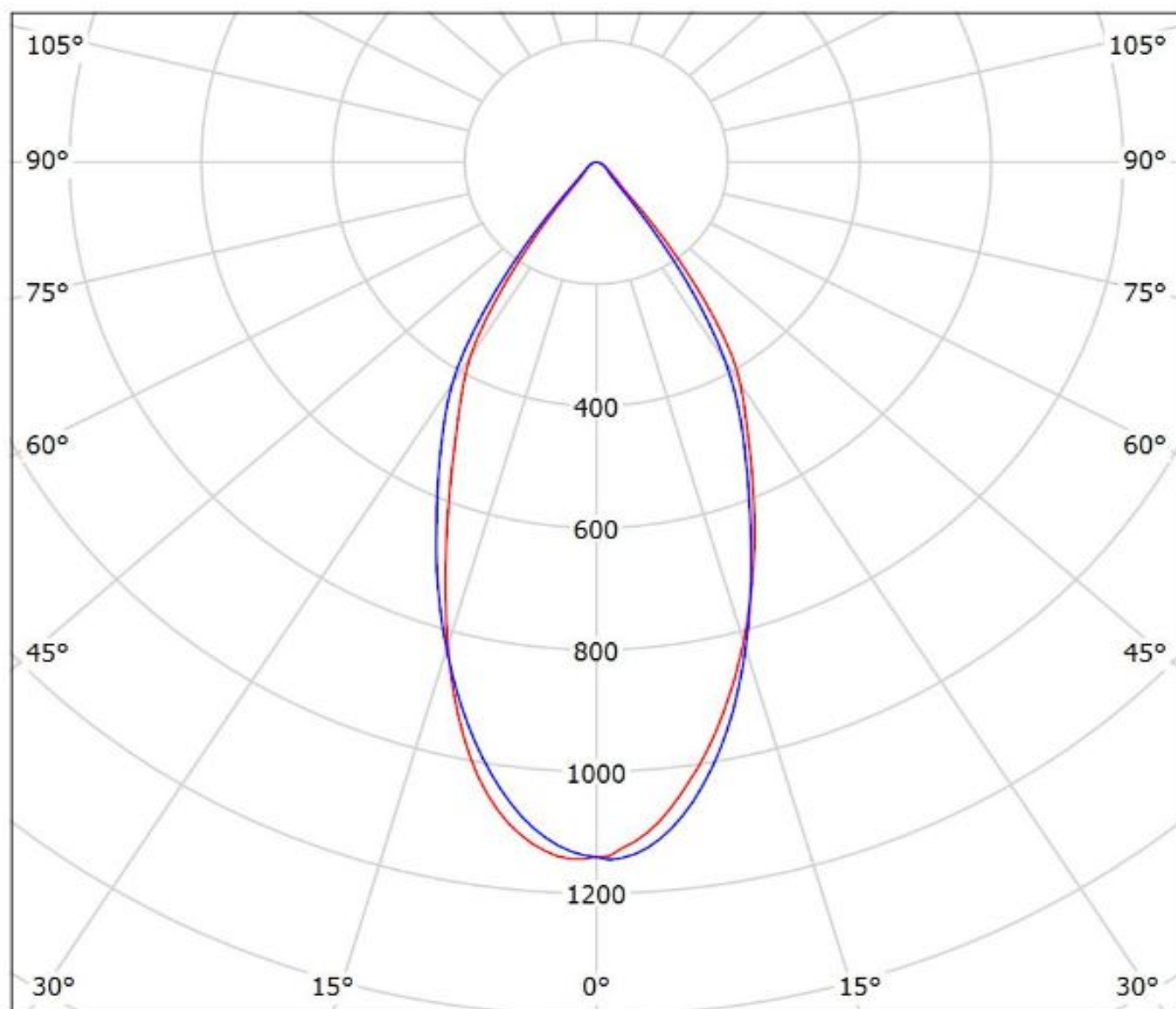

cd/klm

— C0 - C180 — C90 - C270

$\eta = 83\%$

Luminaire: Ledil CN13520\_MIRELLA-50-W-CL\_(CLU700)

Lamps: 1 x Citizen\_CLU700\_395.592lm@100mA\_P=2.815W\_I=0.1A

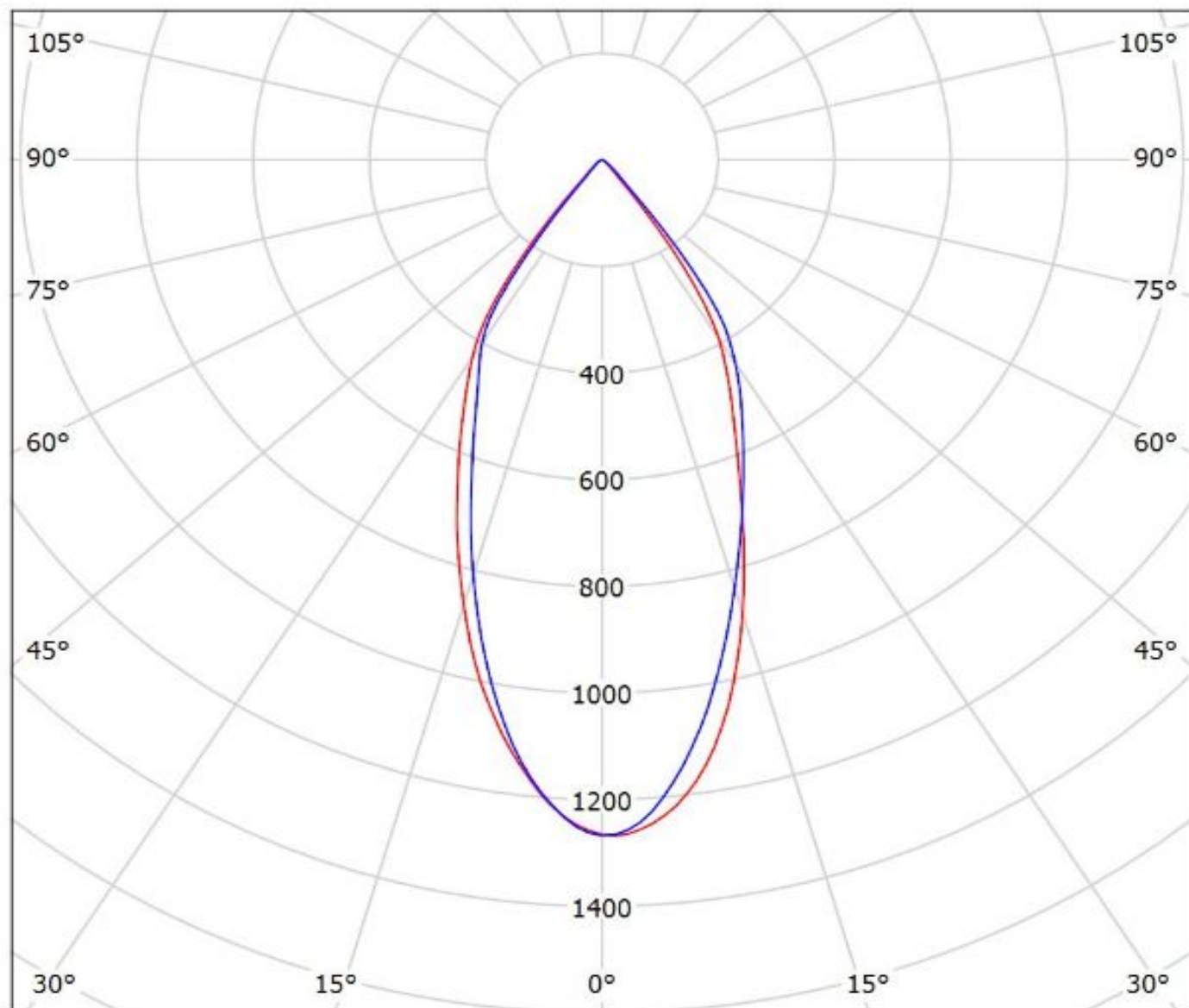

cd/klm

— C0 - C180 — C90 - C270

$\eta = 82\%$

Luminaire: LEDiL Oy CN13520\_MIRELLA-50-W-CL\_(CREE\_XHP50\_WARM\_WHITE)  
Lamps: 1 x CREE\_XHP50\_WARM\_WHITE\_194.925lm@250mA\_P=1.39897W\_I=0.2499A

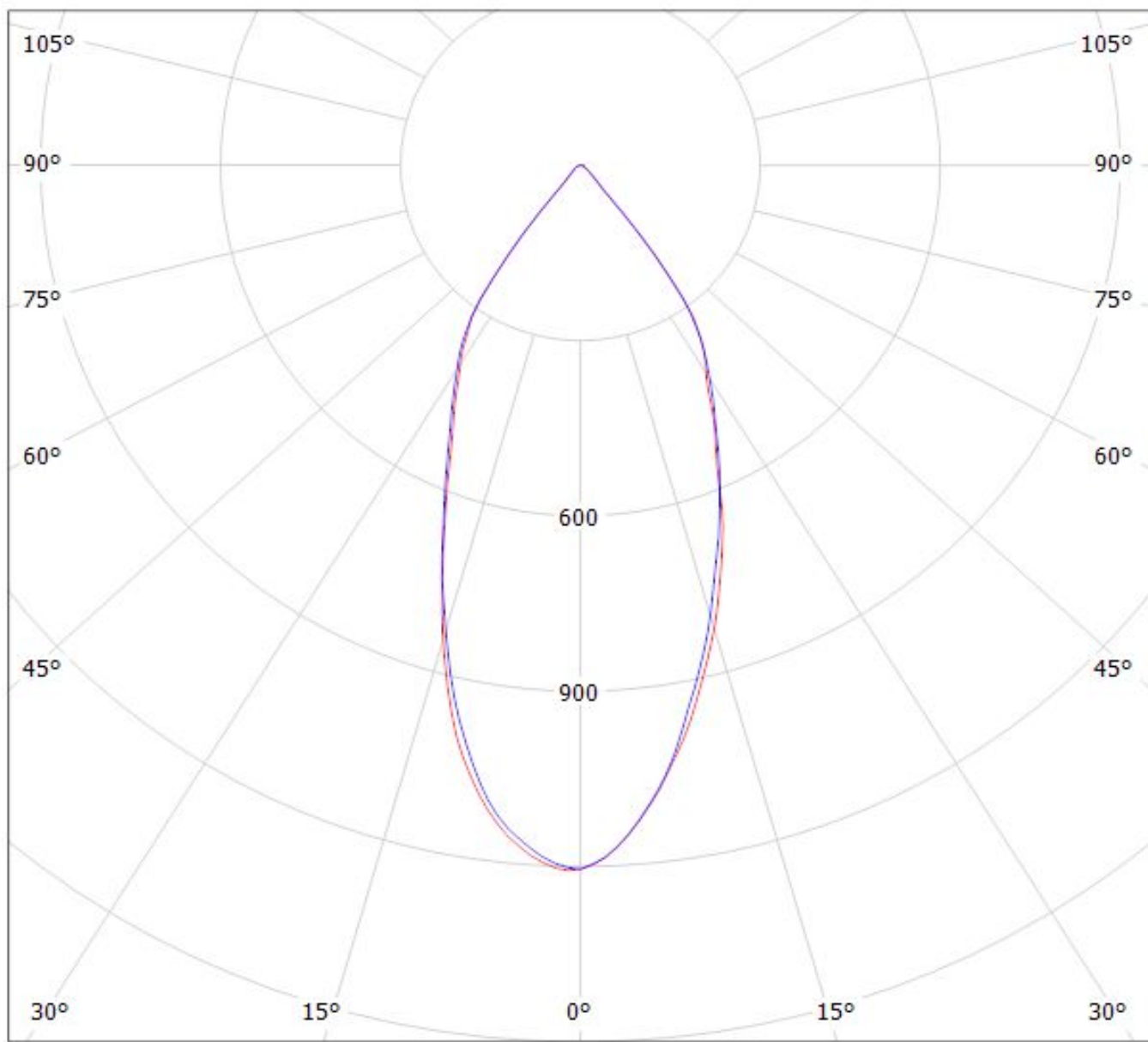

cd/klm

— C0 - C180 — C90 - C270

$\eta = 84\%$



Luminaire: LEDiL Oy CN13520\_MIRELLA-50-W-CL\_(Cree\_XHP70)  
Lamps: 1 x Cree\_XHP70\_258.083lm@250mA\_P=1.38117W\_I=0.2499A

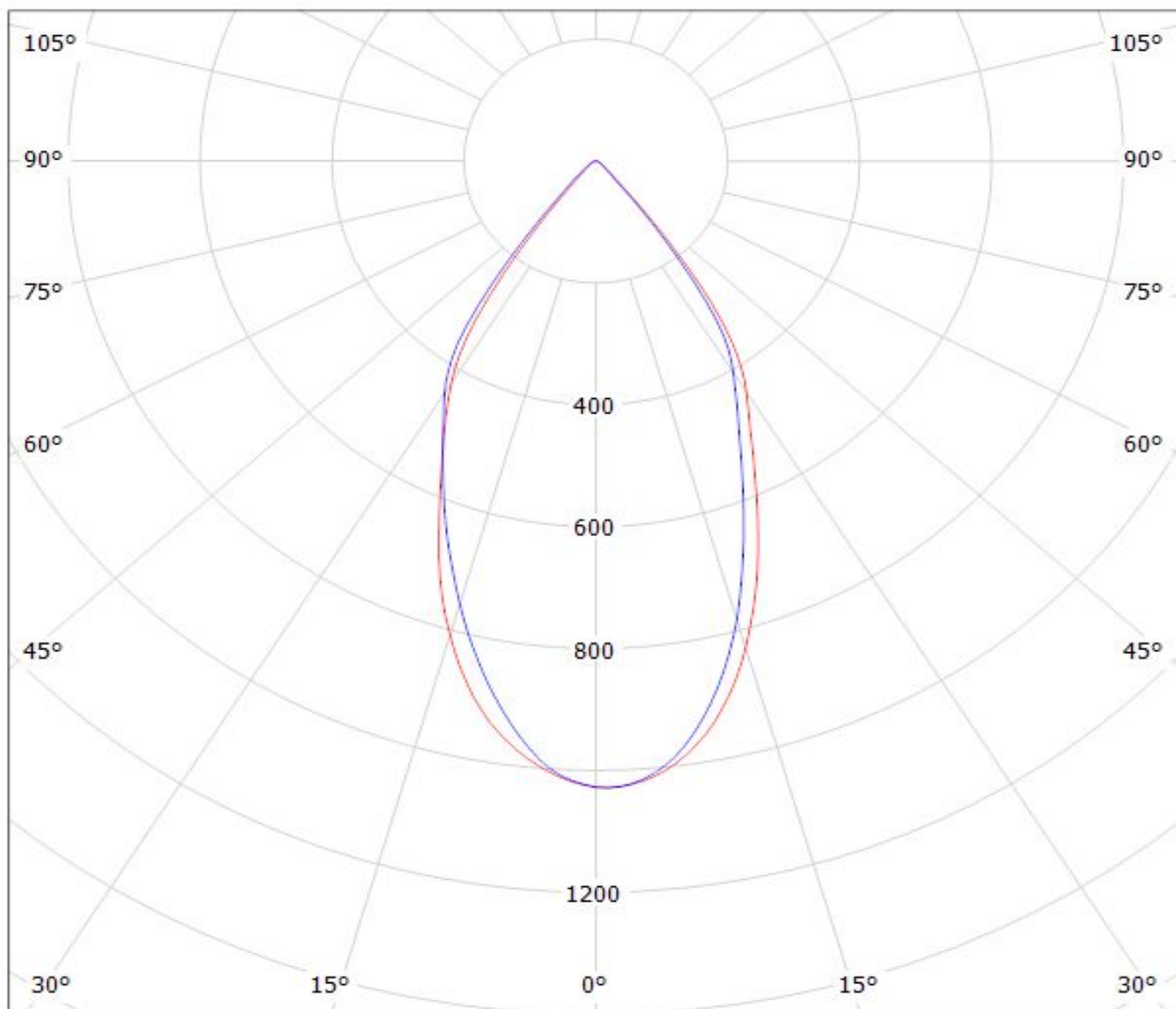

cd/klm

— C0 - C180 — C90 - C270

$\eta = 84\%$

Luminaire: Ledil CN13520\_MIRELLA-50-W-CL\_(MHD-G)  
Lamps: 1 x Cree MHD-G\_528.649lm@100mA\_P=3.0W\_I=0.100A

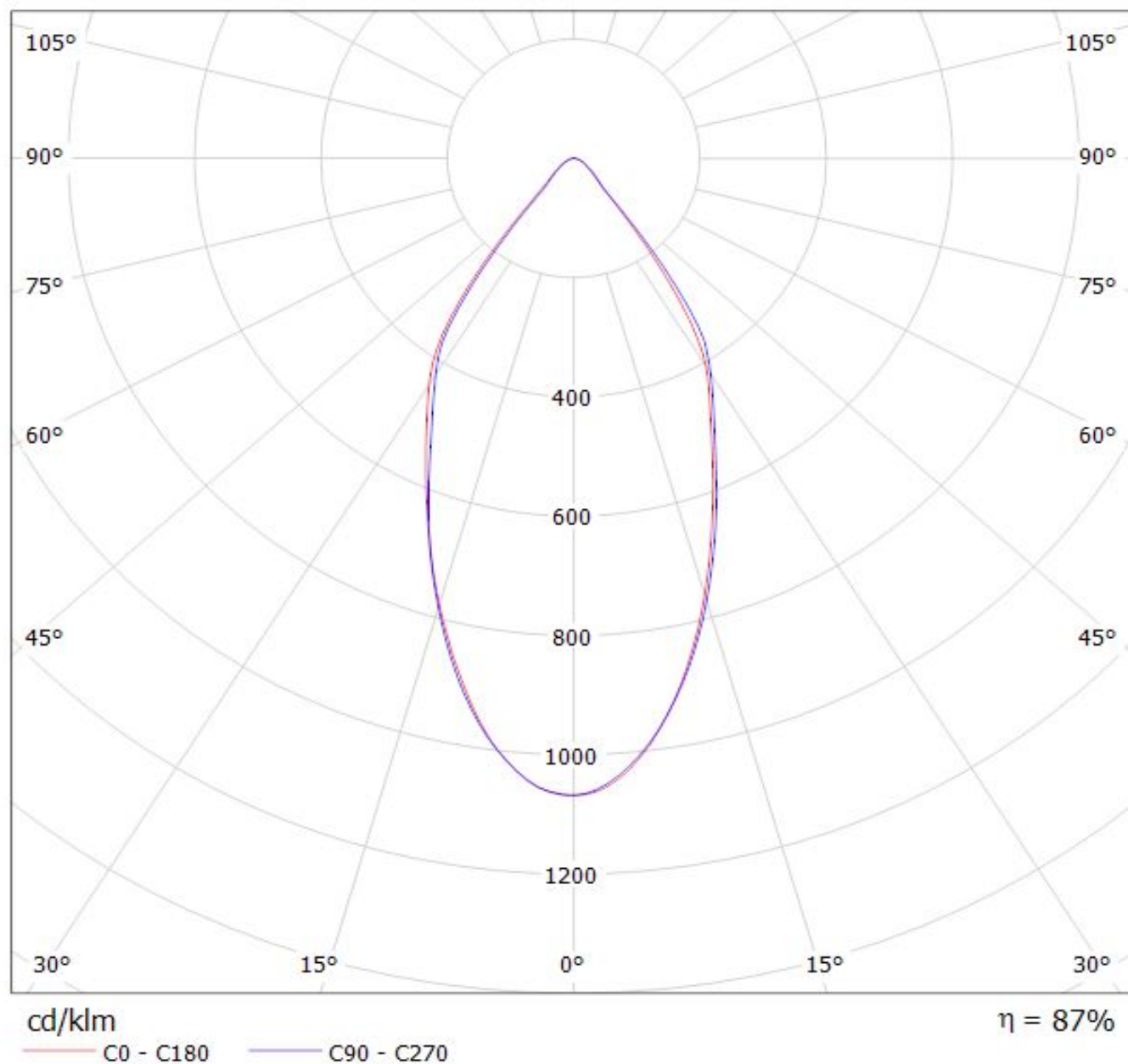



Luminaire: Ledil Oy CN13520\_MIRELLA-50-W-CL\_(Luxeon\_CoB\_1203) Efficiency=86%  
Lamps: 1 x Luxeon Cob 1203 (LHC1-3080-1203) 824lm @ 250mA CCT=3000K P=8.7W I=250mA

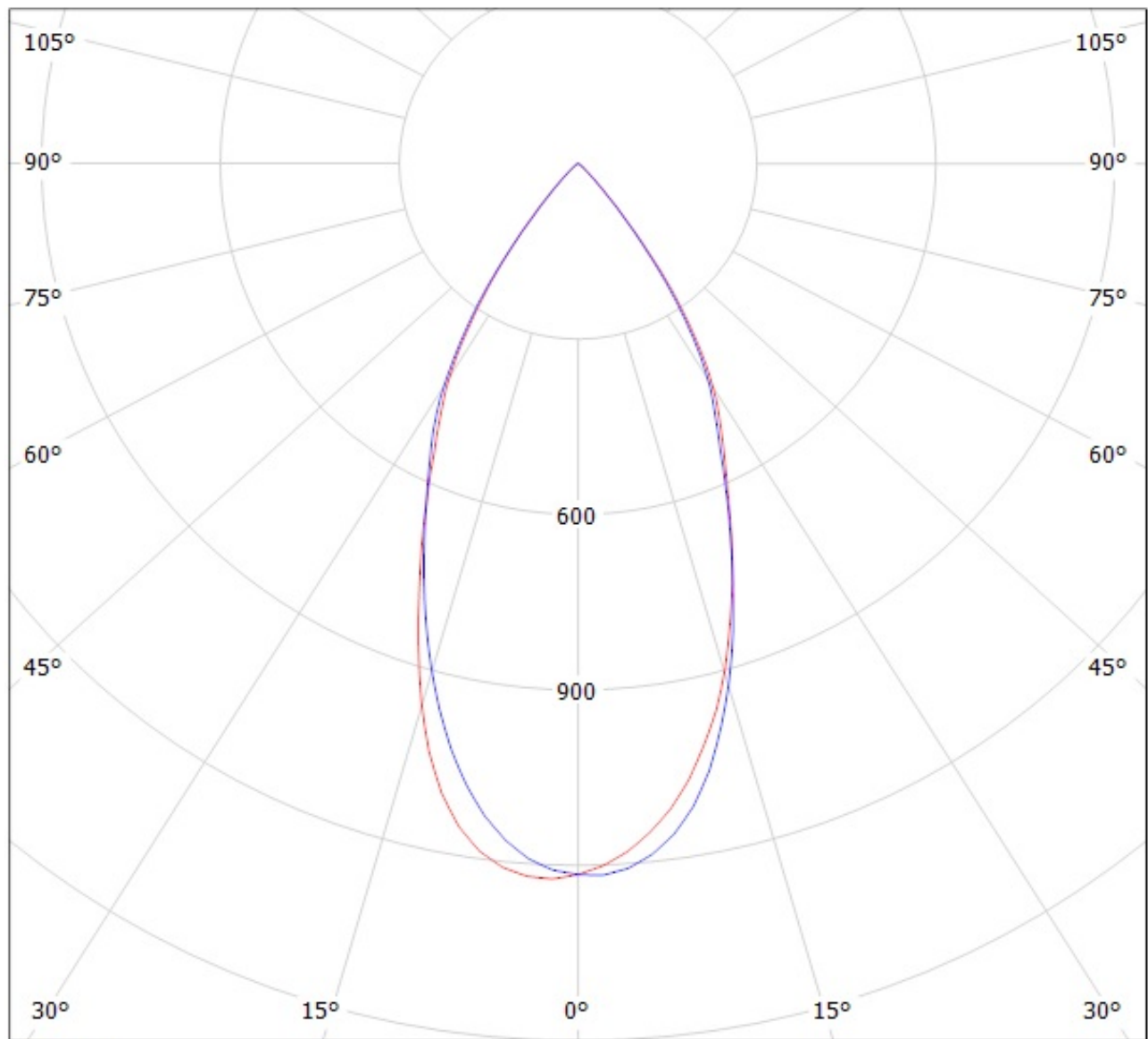

cd/klm

— C0 - C180    — C90 - C270

Luminaire: LEDiL Oy CN13520\_MIRELLA-50-W-CL\_(CXM-9)

Lamps: 1 x Luminus\_XNOVA\_CXM-9\_(AA00)\_974.297lm@240mA\_P=8.2836W\_I=240mA

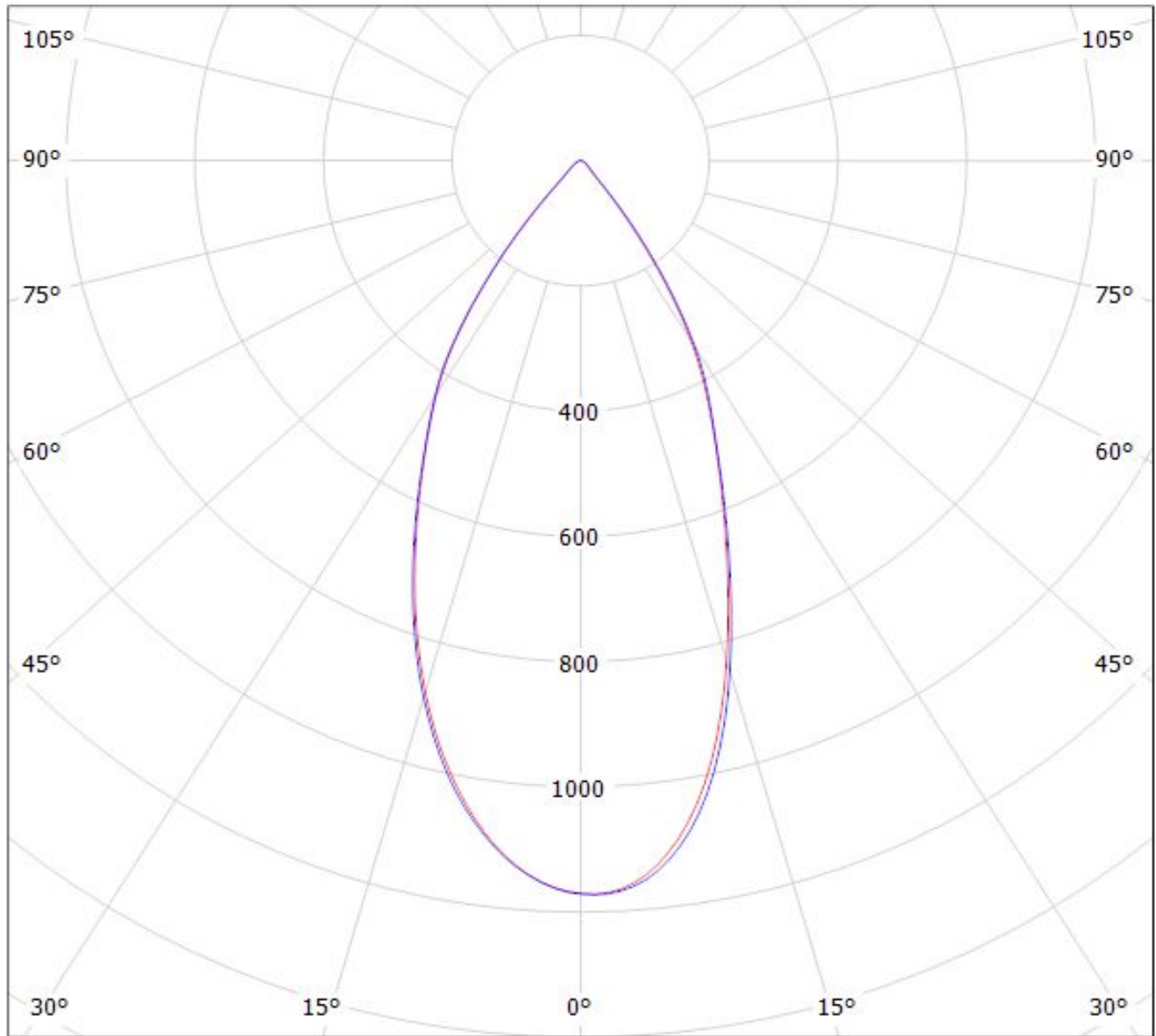

cd/klm

— C0 - C180

— C90 - C270

$\eta = 83\%$

Luminaire: Ledil Oy CN13520\_MIRELLA-50-W-CL (NSBxL066A 930lm @ 250mA) Efficiency=85%  
Lamps: 1 x NSBxL066A 930lm @ 250mA (NSBLL066AE) CCT=3536K P=7,75W I=250mA

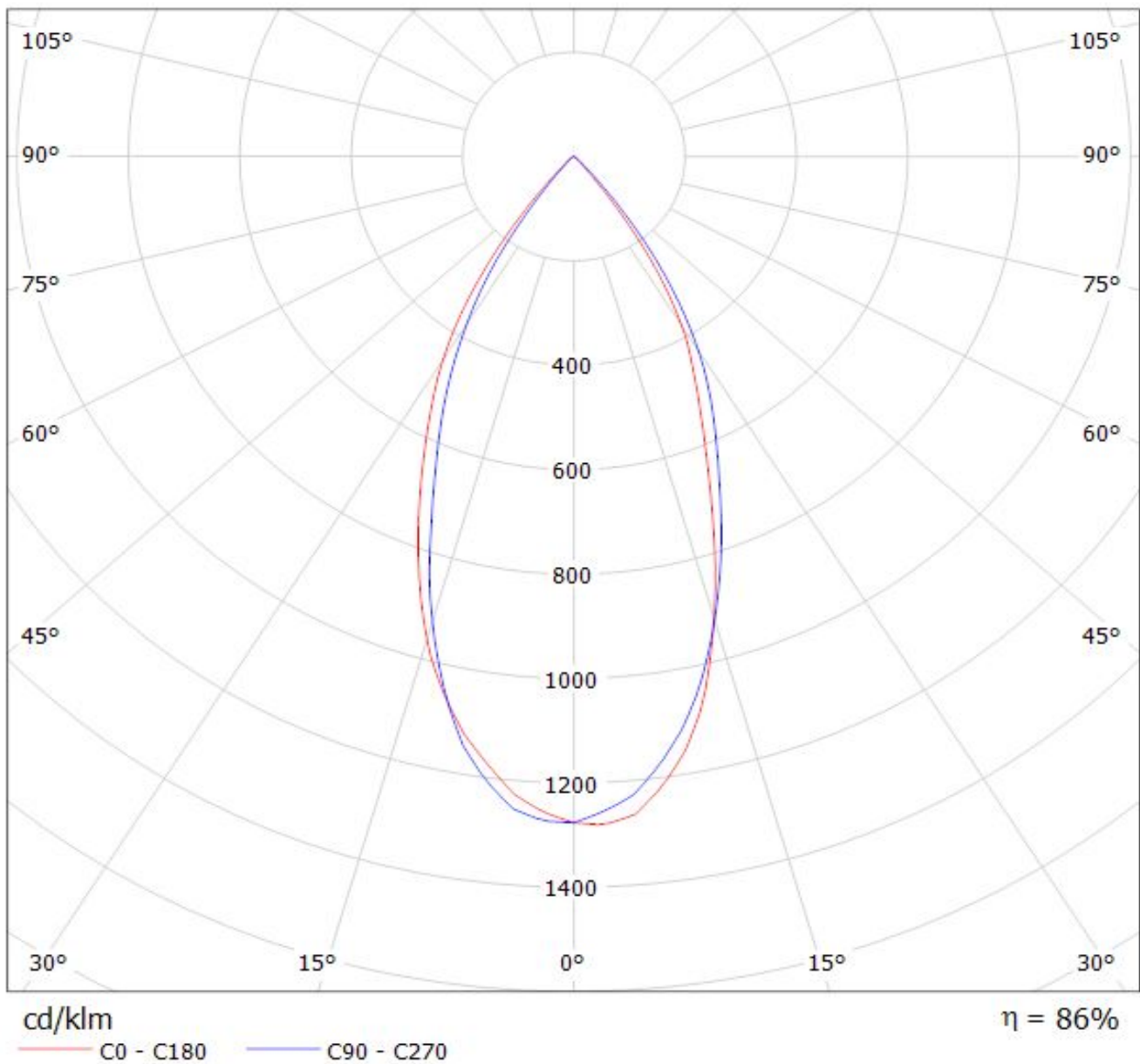

Luminaire: Ledil Oy CN13520\_MIRELLA-50-W-CL (Nichia NSCxL036A 434lm @ 100mA) Efficiency=83%  
Lamps: 1 x Nichia NSCxL036A 434lm @ 100mA (NSCLL036A) CCT=3000K P=3,4W I=100mA

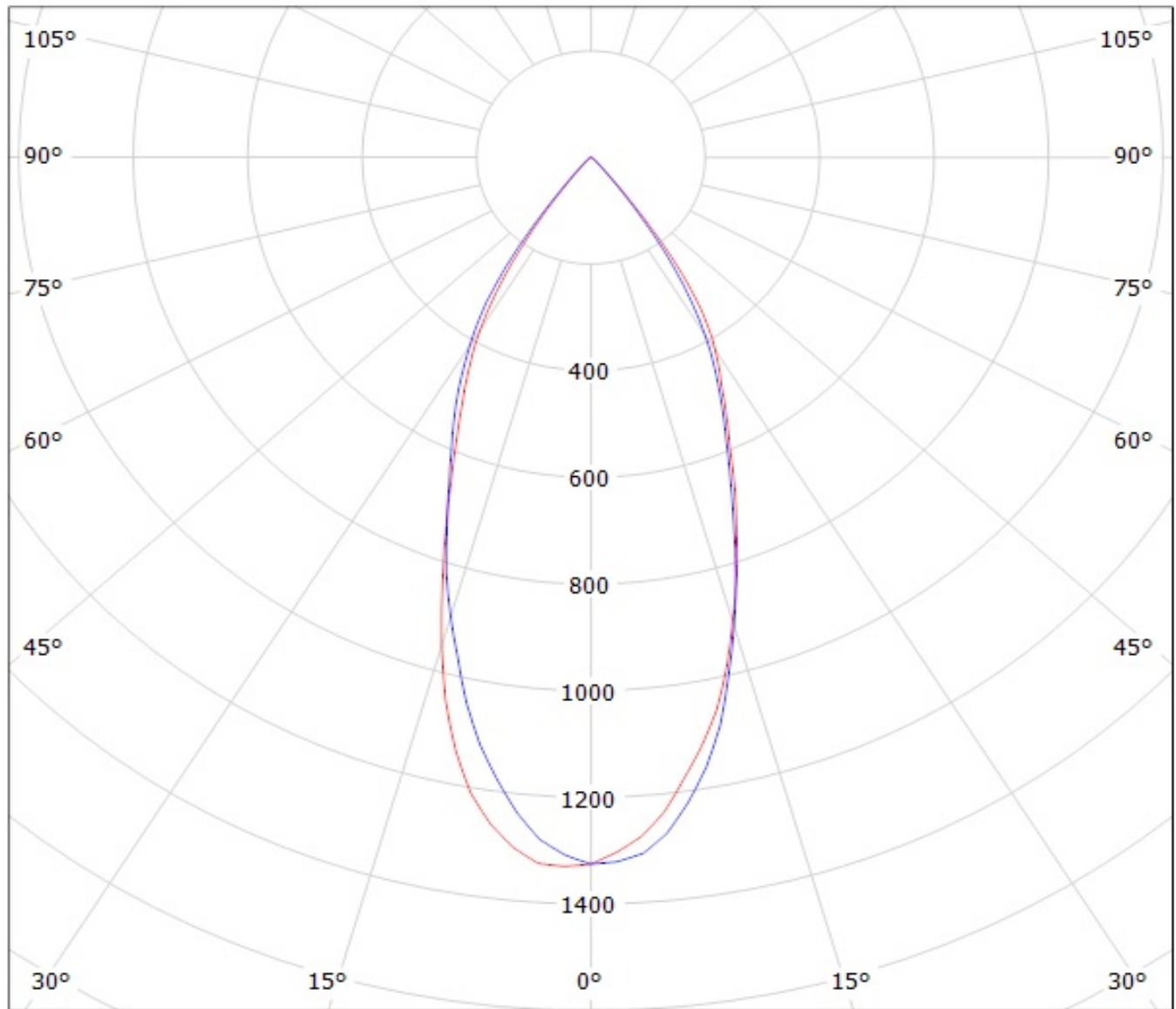

cd/klm

— C0 - C180    — C90 - C270

Luminaire: LEDil Oy CN13520\_MIRELLA-50-W-CL\_(Soleriq\_S13) Efficiency=80%  
Lamps: 1 x Osram Soleriq S13 (GW KAGHB1.EM) 832lm @ 250mA CCT=3100K P=7.4W I=250mA

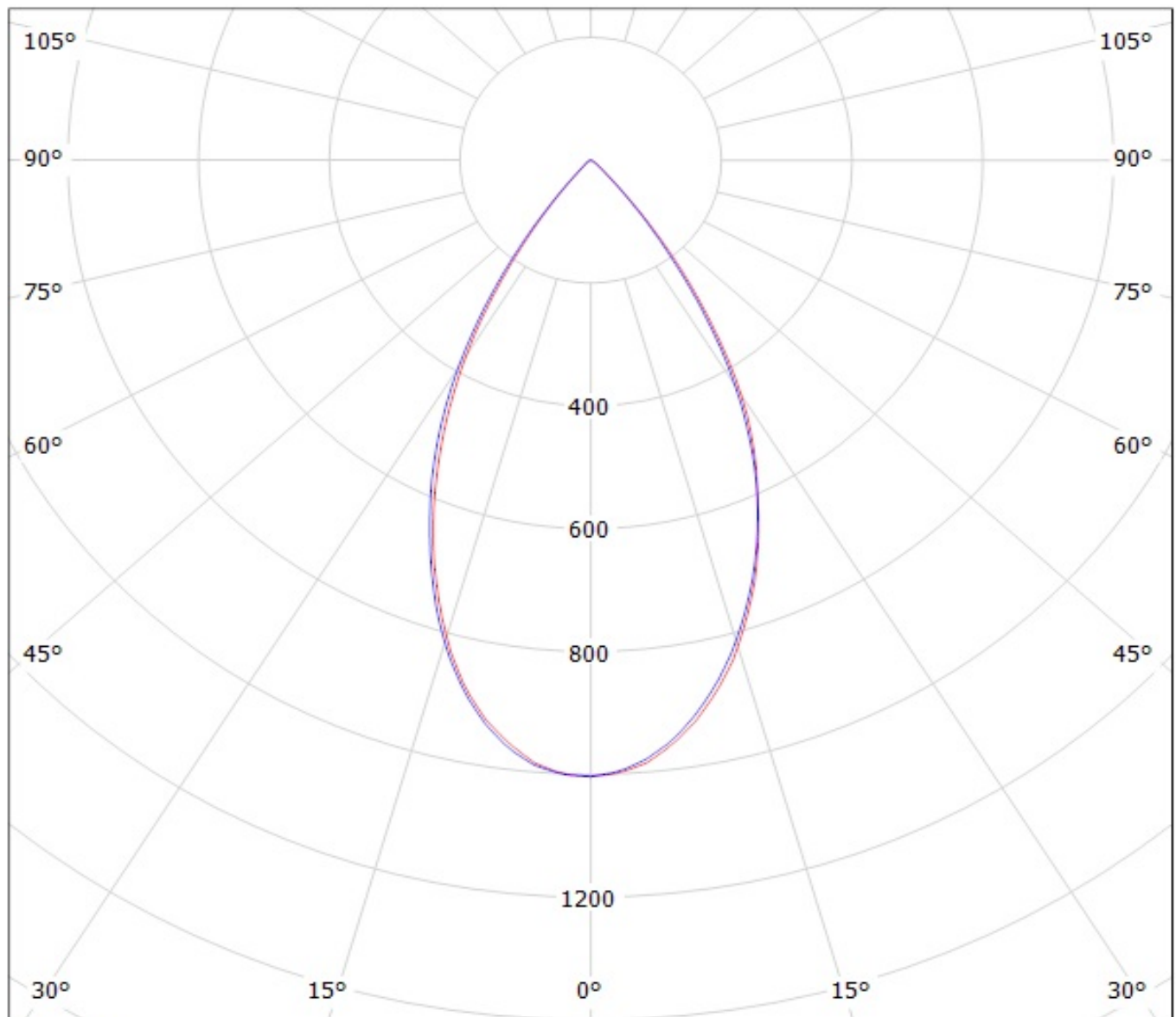

cd/klm

— C0 - C180 — C90 - C270

Luminaire: Ledil Oy CN13520\_MIRELLA-50-W-CL\_(Soleriq\_S9)\_SIMULATED  
Lamps: 1 x Osram Soleriq S9 (GW KAFJB3.EM)

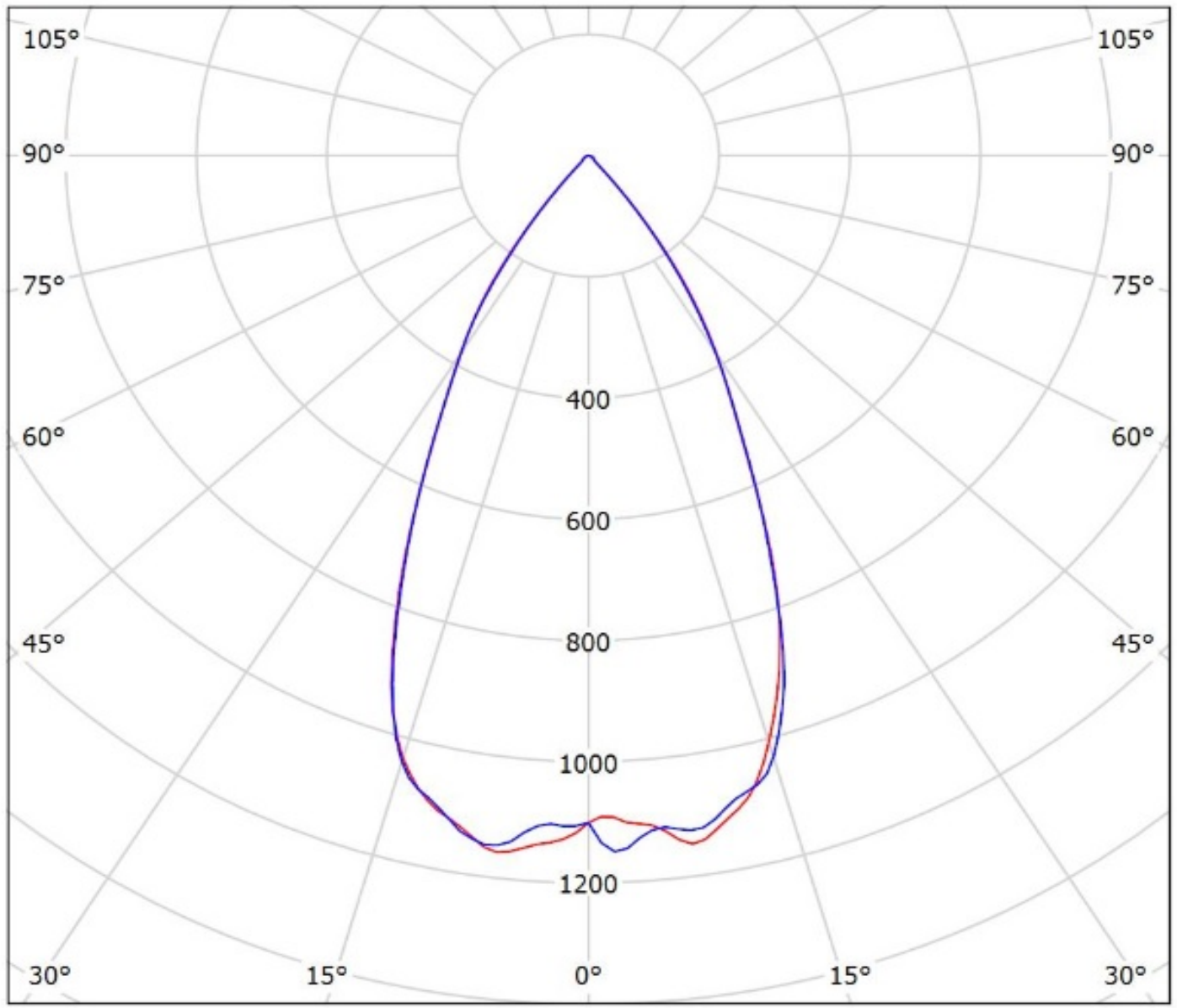

cd/klm

— C0 - C180 — C90 - C270

$\eta = 87\%$



Luminaire: LEDil Oy CN13520\_MIRELLA-50-W-CL\_(ZC6) Efficiency=81%  
Lamps: 1 x Seoul ZC6 (SDW18F1C) 422lm @ 100mA CCT=3100K P=3.4W I=100mA

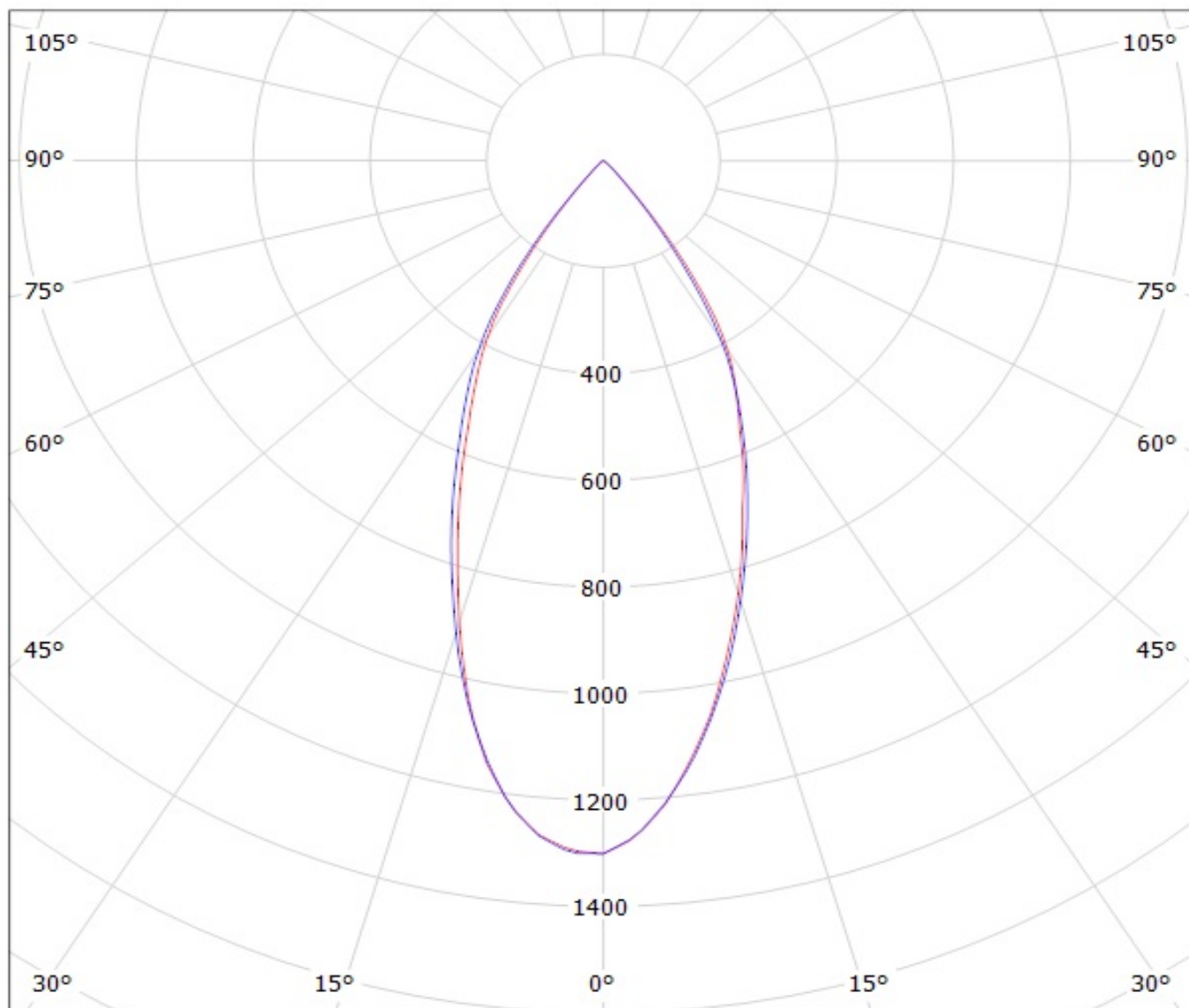

cd/klm

— C0 - C180

— C90 - C270

Luminaire: LEDil Oy CN13520\_MIRELLA-50-W-CL\_(Stark\_SLE\_G3\_LES10) Efficiency=81%

Lamps: 1 x Tridonic Stark SLE G3 LES10 (STARK-SLE-PURE-G3-10-1000-830-CLA) 453lm @ 250mA CCT=3000K P=4.3W I=250mA

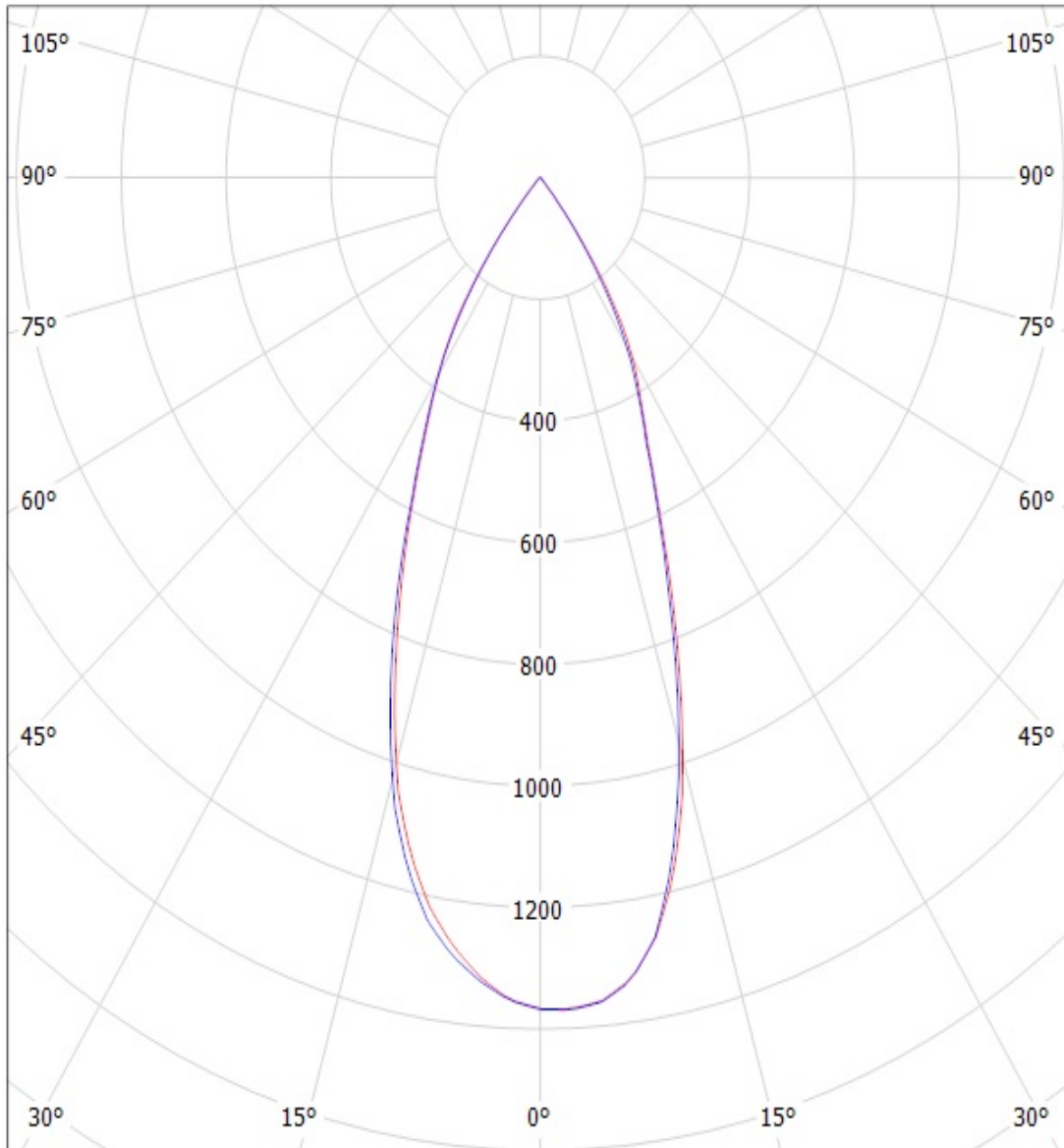

cd/klm

— C0 - C180

— C90 - C270



**NOTE: The typical divergence will be changed by different color, chip size and chip position tolerance. The typical total divergence is the full angle measured where the luminous intensity is half of the peak value.**

### **GENERAL INFORMATION**

- Product series especially designed & optimized for series of LEDs.
- Special care taken to make light distribution as uniform as possible.

Note! Due to use of high power COB's with this product, special attention to proper thermal design is highly recommended. LEDiL has no liability for direct, indirect or consecutive damages arising from the LEDiL products being used outside of the recommended temperature range.