

MAX11131 Evaluation Kit

Evaluates: MAX11131

General Description

The MAX11131 evaluation kit (EV kit) is a fully assembled and tested PCB that evaluates the MAX11131 16-channel, 12-bit, SPI, 3Msps ADC. The EV kit also includes Windows XP[®]-, Windows Vista[®]-, and Windows[®] 7-compatible software that provides a simple graphical user interface (GUI) for exercising the features of the IC. The EV kit comes with a MAX11131ATI+ installed in a 28-pin TQFN package with an exposed pad.

Features

- ◆ On-Board 2.048V and 2.5V Reference Voltage (REF+)
- ◆ On-Board Input Buffers for Four Channels
- ◆ Resistor Ladder for Quick Evaluation
- ◆ Windows XP-, Windows Vista-, and Windows 7- Compatible Software
- ◆ USB PC Connection
- ◆ Proven PCB Layout
- ◆ Fully Assembled and Tested

Ordering Information appears at end of data sheet.

Component List

DESIGNATION	QTY	DESCRIPTION
AIN0+–AIN3+, AIN0– –AIN3–, CNVST, CS, DIN, DOUT, EOC, SCLK	14	White test points
AIN0+_SMA– AIN3+_ SMA, AIN0–_SMA– AIN3–_SMA, 10MHZCLK	9	50Ω SMA female jacks
C1, C3	2	1000pF ±5%, 50V C0G ceramic capacitors (0603) Murata GRM1885C1H102JA
C2, C4, C31, C43, C47, C55–C72, C78, C79, C80, C82, C84, C86, C97, C98, C103, C104, C109, C110, C115, C116, C121– C126	41	0.1μF ±10%, 25V X7R ceramic capacitors (0603) Murata GRM188R71E104K
C5–C29, C34, C35, C37, C46	29	0.1μF ±10%, 16V X7R ceramic capacitors (0402) Murata GRM155R71C104K
C30, C120, C127, C128, CB1, CB2, CB3	7	1μF ±10%, 16V X7R ceramic capacitors (0603) Murata GRM188R71C105K

DESIGNATION	QTY	DESCRIPTION
C32	1	0.01μF ±10%, 16V X7R ceramic capacitor (0603) Murata GRM188R71C103K
C33, C48, C96, C99, C102, C105, C108, C111, C114, C117	10	10μF ±10%, 10V X7R ceramic capacitors (0805) Murata GRM21BR71A106K
C36	1	0.47μF ±10%, 16V X7R ceramic capacitor (0603) Murata GRM188R71C474K
C38, C39, C40, C129	4	4.7μF ±10%, 6.3V X5R ceramic capacitors (0603) Murata GRM188R60J475K
C41, C44, C45, C73, CP2, CP3	6	10μF ±10%, 6.3V X5R ceramic capacitors (0603) Murata GRM21BR71A106K
C42, C49–C54, C87– C95	16	1000pF ±5%, 50V C0G ceramic capacitors (0402) Murata GRM1555C1H102J
C74, C101, C107, C113, C119	0	Not installed, ceramic capacitors (0603)
C75, C76	2	18pF ±5%, 50V C0G ceramic capacitors (0603) Murata GRM1885C1H180J
C77, C81	2	10μF ±20%, 10V capacitors (Tant B) KEMET T491B106M010AT

Windows, Windows XP, and Windows Vista are registered trademarks of Microsoft Corp.

MAX11131 Evaluation Kit

Evaluates: MAX11131

Component List (continued)

DESIGNATION	QTY	DESCRIPTION
C83, C85	2	4.7 μ F \pm 20%, 25V capacitors (Tant B) AVX TAJB475M025R
C100, C106, C112, C118	0	Not installed, capacitors (through-hole)
CC1–CC4	4	10pF \pm 5%, 50V C0G ceramic capacitors (0603) Murata GRM1885C1H100J
CP1	1	100 μ F \pm 20%, 6.3V X5R ceramic capacitor (1210) Murata GRM32ER60J107M
CPU_RESET, INT_DEBUG, RECONFIGURE	3	Pushbutton switches
DGND, GND (10x)	11	Black test points
EXT_OVDD, EXT_REF+, EXT_VDD, OP+, OVDD, REF+, VDD, VIN	8	Red test points
H1	1	Dual-row, 32-pin (2 x 16) header
H2	0	Not installed, dual-row, 32-pin (2 x 16) header
J2	1	USB type-B, right-angle PC-mount receptacle
JTAG1, JTAG2	0	Not installed, dual-row 10-pin (2 x 5) headers
JU1, JU2, JU4–JU16, JU21–JU24, JU35–JU39	24	3-pin headers
JU3	1	4-pin header
JU17–JU20	4	5-pin headers
JU25–JU32, JU40–JU44	13	2-pin headers
JU33, JU34	0	Not installed, 2-pin headers
JUC1–JUC7	0	Not installed, 3-pin headers
L1	1	Ferrite bead (0603) TDK MMZ1608R301A
LED1–LED4	4	Red LEDs (0603)
OP-, REF-	2	Brown test points
R1, R2, R5, R6, R7, R95	6	100k Ω \pm 5% resistors (0603)
R4, R8, R9, R37–R40, R43–R51	16	10 Ω \pm 1% resistors (0402)

DESIGNATION	QTY	DESCRIPTION
R10, R33	2	22 Ω \pm 5% resistors (0603)
R11–R21	11	5.1k Ω \pm 5% resistors (0603)
R22–R25, R28, R34, R35, R41, R97	9	10k Ω \pm 1% resistors (0603)
R26, R96	2	16.5k Ω \pm 1% resistors (0603)
R27	1	4.42k Ω \pm 1% resistor (0603)
R29	1	20k Ω \pm 1% resistor (0603)
R30, RC1–RC7	8	10k Ω \pm 5% resistors (0603)
R31, R72, R75, R78, R81, R84, R87, R90, R93	0	Not installed, resistors (0603)
R32	1	12.1k Ω \pm 1% resistor (0603)
R36, R54	2	0 Ω \pm 1% resistors (0603)
R52, R53	0	Not installed, resistors (through hole)
R55–R70	16	200 Ω \pm 1% resistors (0603)
R71, R73, R74, R76, R77, R79, R80, R82, R83, R85, R86, R88, R89, R91, R92, R94	16	1k Ω \pm 5% resistors (through hole)
RC8–RC10	3	1k Ω \pm 5% resistors (0603)
RL1–RL4	4	120 Ω \pm 5% resistors (0603)
RN14–RN21	8	22 Ω , 16-pin/8-resistor SMT resistor networks
RN22	1	5.1k Ω , 8-pin/4-resistor SMT resistor network
RN25	1	10k Ω , 8-pin/4-resistor SMT resistor network
S1	1	4-position, half-pitch SMT DIP switch
U1	1	16-channel, 12-bit, 3Msps ADC (28 TQFN-EP*) Maxim MAX11131ATI+
U2	1	Altera Cyclone III FPGA Altera EP3C25F324C8N
U3, U10, U11, U12	4	LDOs (16 TSSOP-EP*) Maxim MAX1793EUE50+
U5	1	256K x 36 SSRAM (100 TQFP) ISSI IS61LPS25636A 200TQLI
U6	0	Not installed, 32M x 16 flash (64 EBGA)
U7	1	EPCS16 (8 SO) Altera EPCS16SI8N
U8, U9, U16, U17	4	Input buffers (5 SOT23) Maxim MAX4430EUK+

MAX11131 Evaluation Kit

Evaluates: MAX11131

Component List (continued)

DESIGNATION	QTY	DESCRIPTION
U13	1	LDO (6 SOT23) Maxim MAX1983EUT+
U14	1	SRAM (48 TSOP) Cypress CY62167DV30LL 55ZXI
U15	1	USB PHY (SOT617-1) ST Ericsson ISP1504ABS
U18	1	2.048V voltage reference (8 SO) Maxim MAX6126AASA21+

DESIGNATION	QTY	DESCRIPTION
U19	1	2.5V voltage reference (8 SO) Maxim MAX6126AASA25+
Y1	1	50MHz oscillator
Y2	1	19.2MHz SMD XTAL (18pF)
—	1	USB high-speed A-to-B cables, 5ft (1.5m)
—	42	Shunts
—	1	PCB: MAX11131 EVALUATION KIT

*EP = Exposed pad.

Component Suppliers

SUPPLIER	PHONE	WEBSITE
Altera Corp.	800-800-3753	www.altera.com
AVX Corporation	843-946-0238	www.avxcorp.com
KEMET Corp.	864-963-6300	www.kemet.com
Murata Electronics North America, Inc.	770-436-11131	www.murata-northamerica.com

Note: Indicate that you are using the MAX11131 when contacting these component suppliers.

MAX11131 EV Kit Files

FILE	DESCRIPTION
INSTALL.EXE	Installs the EV system files on your computer
MAX11131.EXE	Application program
SLSUSB.DLL	Software library file
SLSUSB.INF	USB device driver file
SLSUSB.SYS	USB device driver file
SLS_USB_Driver_Help_100.PDF	USB device driver help file

Quick Start

Required Equipment

- MAX11131 EV kit
- +5V, 750mA DC power supply
- Windows XP, Windows Vista, or Windows 7 PC with a spare USB port

Note: In the following sections, software-related items are identified by bolding. Text in **bold** refers to items directly from the EV kit software. Text in **bold and underline** refers to items from the Windows operating system.

Procedure

The EV kit is fully assembled and tested. Follow the steps below to verify board operation. **Caution: Do not turn on the power supply until all connections are completed.**

- 1) Visit www.maxim-ic.com/evkitsoftware to download the latest version of the EV kit software, 11131Rxx.Zip. Save the EV kit software to a temporary folder and uncompress the zip file.
- 2) Install the EV kit software on your computer by running the INSTALL.EXE program inside the temporary folder. The program files are copied to your PC and icons are created in the Windows **Start | Programs** menu. During software installation, some versions of Windows may show a warning message indicating that this software is from an unknown publisher. This is not an error condition and it is safe to proceed with installation. Administrator privileges are required to install the USB device driver on Windows.
- 3) Verify that all jumpers are in their default positions, as shown in Table 1.
- 4) Connect the +5V DC power supply to the VIN and GND test points.
- 5) Turn on the power supply.

MAX11131 Evaluation Kit

Evaluates: MAX11131

- 6) Connect the USB cable from the PC to the EV kit board. Follow the instructions on the SLS_USB_Driver_Help_100.PDF file to manually install the USB driver. Administrator privileges are required to install the USB device driver on Windows.
- 7) Start the EV kit software by opening its icon in the Windows **All Programs** menu.
- 8) Press the **Start Conversion** button.
- 9) From the **Device Configuration** tab sheet, select 0110 UPPER_EXT from the **SCAN** drop-down list.
- 10) Select the **Data Analysis** tab sheet.
- 11) Press the **Start Conversion** button.
- 12) Observe the scope image (as shown in Figure 1) and verify the data sampled is valid.

Precision Quick Start

Required Equipment

- MAX11131 EV kit
- +5V, 750mA DC power supply
- $\pm 5V$, 100mA DC power supply
- Windows XP, Windows Vista, or Windows 7 PC with a spare USB port
- Function generator

Note: In the following sections, software-related items are identified by bolding. Text in **bold** refers to items directly from the EV kit software. Text in **bold and underline** refers to items from the Windows operating system.

Procedure

The EV kit is fully assembled and tested. Follow the steps below to verify board operation. **Caution: Do not turn on the power supply until all connections are completed.**

- 1) Visit www.maxim-ic.com/evkitsoftware to download the latest version of the EV kit software, 11131Rxx.Zip. Save the EV kit software to a temporary folder and uncompress the zip file.
- 2) Install the EV kit software on your computer by running the INSTALL.EXE program inside the temporary folder. The program files are copied to your PC and icons are created in the Windows **Start | Programs** menu. During software installation, some versions of Windows may show a warning message indicating that this software is from an unknown publisher. This is not an error condition and it is safe to proceed with installation. Administrator privileges are required to install the USB device driver on Windows.
- 3) Verify that all jumpers are in their default positions, as shown in Table 1.
- 4) Move the shunt on jumper JU17 to the 1-4 position.
- 5) Connect the +5V DC power supply to the VIN and GND test points.
- 6) On the $\pm 5V$ DC power supply, connect the +5V terminal to the OP+ test point, the -5V terminal to the OP- test point, and the ground terminal to the nearest GND test point.
- 7) Set the function generator to generate a 500kHz, +2.4V peak-to-peak sinusoidal wave with +1.2V offset.
- 8) Connect the positive terminal of the function generator to the AIN0+_SMA connector or AIN0+ test point. Connect the negative terminal of the function generator to the GND test point.
- 9) Turn on the power supplies.
- 10) Enable the function generator.
- 11) Connect the USB cable from the PC to the EV kit board. Follow the instructions on the SLS_USB_Driver_Help_100.PDF file to manually install the USB driver. Administrator privileges are required to install the USB device driver on Windows.
- 12) Start the EV kit software by opening its icon in the Windows **All Programs** menu.
- 13) Select the **Data Analysis** tab sheet.
- 14) Press the **Start Conversion** button.
- 15) Verify the **RMS** value of approximately 1.47V, the **MIN** of 0V, **MAX** of 2.4V, and the **Avg DC** of 1.2V are displayed in the **Calculation** group box.

Detailed Description of Software

The MAX11131 EV kit software main window (Figure 2) contains a **Device Configuration** tab and a **Data Analysis** tab to display the sampled data.

MAX11131 Evaluation Kit

Evaluates: MAX11131

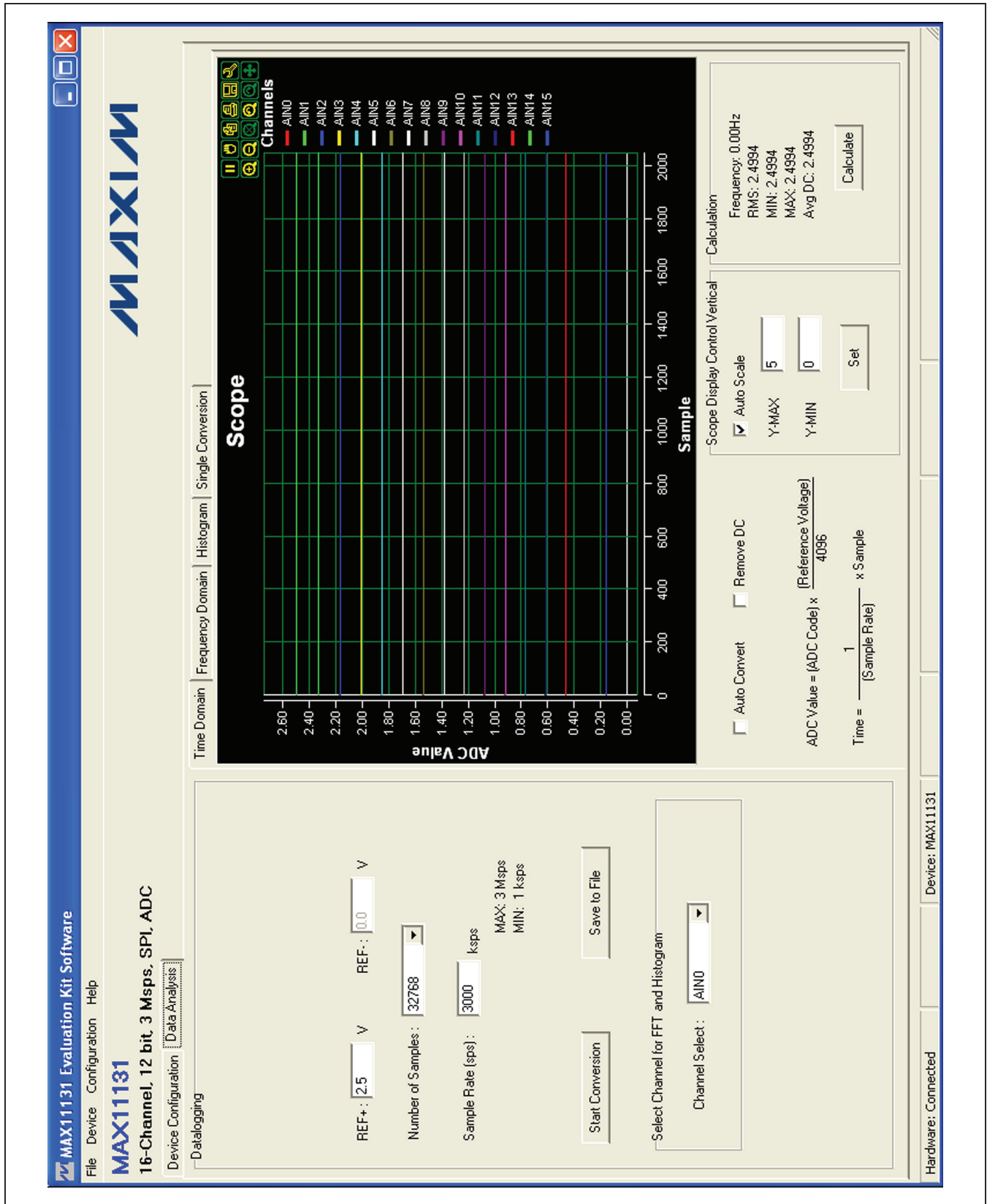

Figure 1. Quick Start Time Domain Scope Shot

MAX11131 Evaluation Kit

Evaluates: MAX11131

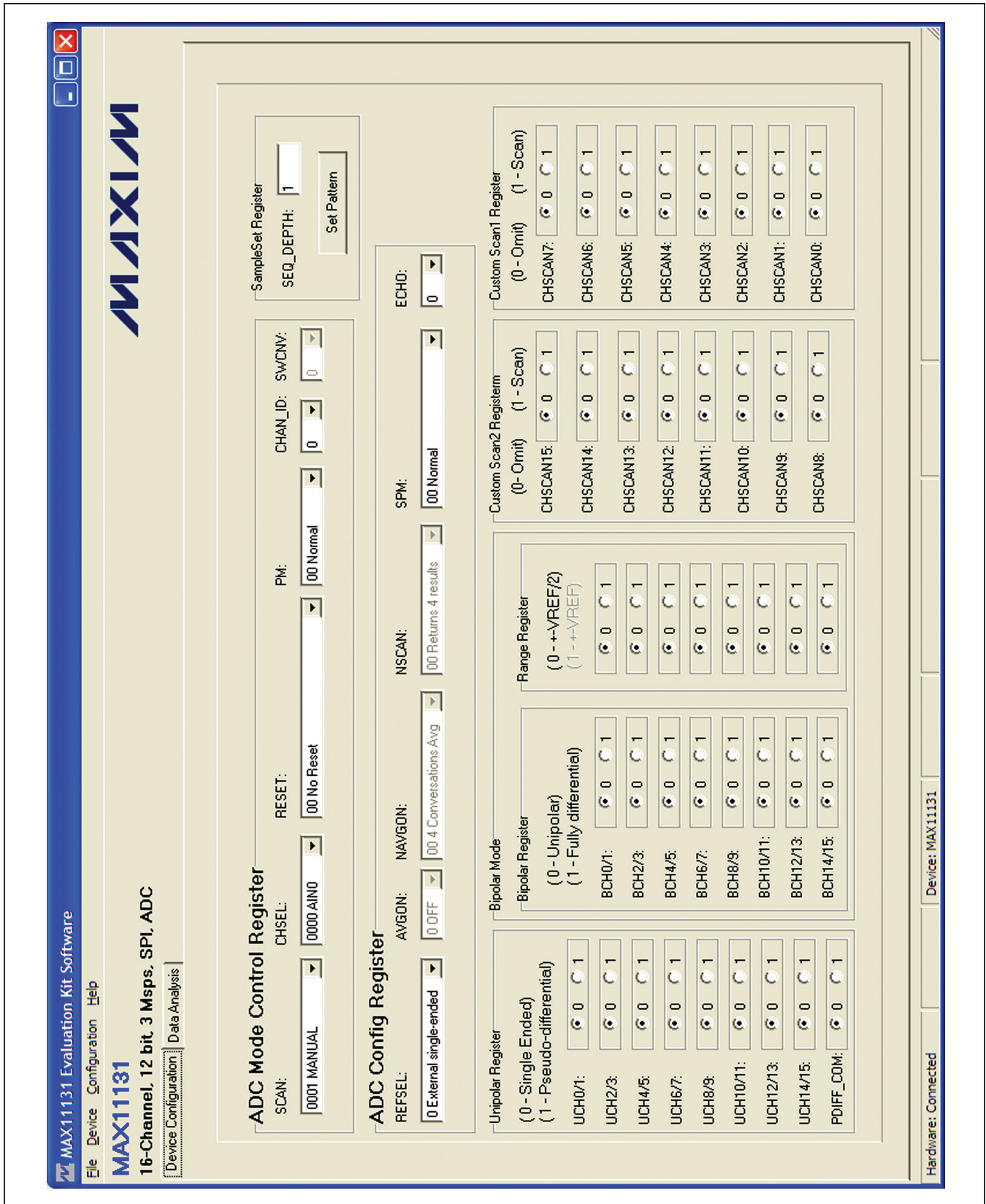

Figure 2. MAX11131 EV Kit Software Main Window (Device Configuration Tab)

MAX11131 Evaluation Kit

Evaluates: MAX11131

Device Configuration

Use the **Device Configuration** tab sheet to configure the MAX11131 ADC.

Each drop-down list in the **ADC Mode Control Register** group box corresponds to a parameter in the ADC Mode Control register. Each drop-down list in the **ADC Config Register** group box corresponds to a parameter in the ADC Configuration register. Use the **Unipolar Register** group box to set the input polarity for each analog input channel. Refer to the MAX11129–MAX11132 IC data sheet for additional information.

To use bipolar inputs, select option 0 (single ended) for the desired channel in the **Unipolar Register** group box, and select option 1 (fully differential) for the same channel in the **Bipolar Register** group box. Use the **Range Register** group box to set the input range. Refer to the MAX11129–MAX11132 IC data sheet for additional information.

If the custom scan mode (0111 CUSTOM_INT or 1000 CUSTOM_EXT) is selected from the **SCAN** drop-down list in the **ADC Mode Control Register** group box, use the **Custom Scan0 Register** and the **Custom Scan1 Register** group boxes to select the desired channels to scan. Refer to the MAX11129–MAX11132 IC data sheet for additional information.

If the SampleSet™ scan mode (1001 SAMPLESET) is selected from the **SCAN** drop-down list in the **ADC Mode Control Register** group box, use the **SampleSet Register** group box to set the sample set pattern. Enter the sample sequence length in the **SEQ_DEPTH** edit box. Press the **Set Pattern** button to bring up the **SampleSet Pattern Selection** window, as shown in Figure 3. In the **SampleSet Pattern Selection** window, select the sequence number on the left side and double click the AIN input on the right side to set the AIN input for the selected sequence number. To clear the sample set pattern, press the **Clear** button. When finished setting the sample set pattern, press the **Ok** button and return to the main window.

Configuration

Press the **Save Configuration** menu item under the **Configuration** menu to save all the settings on the **Device Configuration** tab sheet. To load the saved

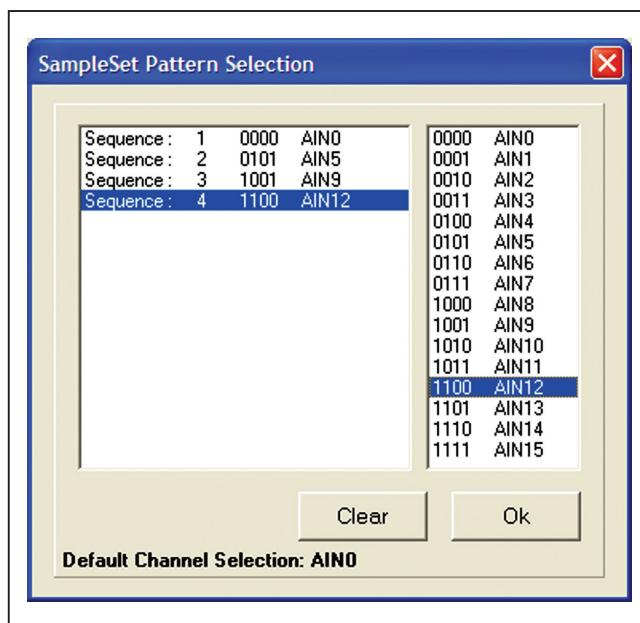

Figure 3. SampleSet Pattern Selection Window

settings, press the **Load Configuration** menu item under the **Configuration** menu.

Press the **Save Configuration as Header** menu item under the **Configuration** menu to save all the settings on the **Device Configuration** tab sheet to a *.h file.

Data Analysis

The **Data Analysis** tab (Figure 4) contains four tab sheets (**Time Domain**, **Frequency Domain**, **Histogram**, and **Single Conversion**) to display the sampled data.

In the **Datalogging** group box, enter the accurate reference voltage in the **REF+** and **REF-** edit boxes. Select the desired number of conversions in the **Number of Samples** drop-down list. Enter the desired sampling rate in the **Sample Rate (sps)** edit box. Press the **Start Conversion** button to start sampling. After sampling is finished, the user can save the data to a file by pressing the **Save to File** button. The **Save to File** button is not active until the sampling is done. Use the **Channel Select** drop-down list in the **Select Channel for FFT and Histogram** group box to select the data set from a specific analog input channel to display on the **Frequency Domain** and the **Histogram** tab sheets.

SampleSet is a trademark of Maxim Integrated Products, Inc.

MAX11131 Evaluation Kit

Evaluates: MAX11131

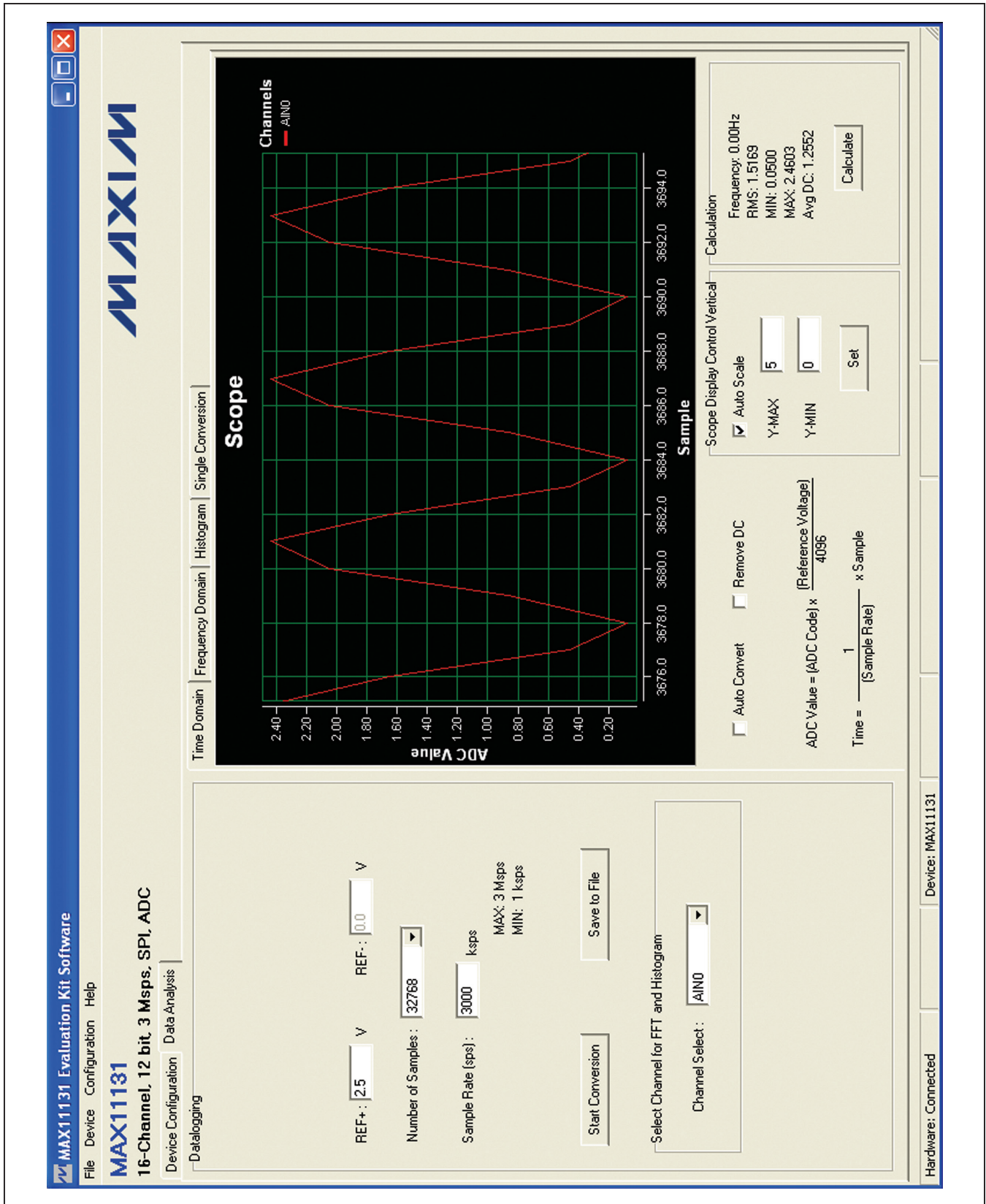

Figure 4. MAX11131 EV Kit Software Main Window (Data Analysis Tab)

MAX11131 Evaluation Kit

Evaluates: MAX11131

Time Domain, Frequency Domain, Histogram, and Single Conversion Tab Sheets

After the **Start Conversion** button in the **Datalogging** group box is pressed, the sampled data in the time domain is plotted in the **Time Domain** tab sheet. **Frequency Domain** tab sheet displays the frequency domain of the signal selected in the **Channel Select** drop-down list. The **Histogram** tab sheet displays the histogram of the signal selected in the **Channel Select** drop-down list. The **Single Conversion** tab sheet displays one data sample for all the input channels.

Check the **Auto Convert** checkbox to automatically and repeatedly do the ADC conversions and update the active tab sheet.

Time Domain Tab

In the **Time Domain** tab sheet (Figure 4), check the **Remove DC** checkbox to remove the DC component of the sampled signal. In the **Scope Display Control Vertical** group box, when the **Auto Scale** checkbox is checked, the software automatically scales the vertical axis in the plot. If the **Auto Scale** checkbox is not checked, enter the appropriate values into the **Y-MAX** and **Y-MIN** edit boxes and press the **Set** button to set the boundaries for the vertical axis. Press the **Calculate** button to show the **Frequency**, **RMS**, **MIN**, **MAX**, and **Avg DC** of the sampled signal in the **Calculation** group box. The frequency calculation is valid only when the **Remove DC** checkbox is checked.

Frequency Domain Tab (Display Frequency in Log Scale)

The **Frequency Domain** tab sheet (Figure 5) displays the FFT plot of the signal selected in the **Channel Select** drop-down list.

Histogram Tab

The **Histogram** tab sheet (Figure 6) displays the histogram of the signal selected from the **Channel Select** drop-down list. The software automatically calculates the **Mean** and the **Std Dev** (standard deviation, sigma) and displays the calculated values in the **Calculation** group box.

The **Histogram Display Control** radio group box provides three options to scale the horizontal axis on the histogram. The options include **(Mean - 3 sigma) to (Mean + 3 sigma)**, **(Mean - 6 sigma) to (Mean + 6 sigma)**, and **User Define** range.

Single Conversion Tab

The **ADC Value Display** group box in the **Single Conversion** tab sheet (Figure 7) displays the **ADC Code** and the calculated **Voltage** values for a single sample of all the channels in standard external clock mode. Pressing the **Start Conversion** button in the **Datalogging** group box updates the status of the **ADC Value Display** group box.

MAX11131 Evaluation Kit

Evaluates: MAX11131

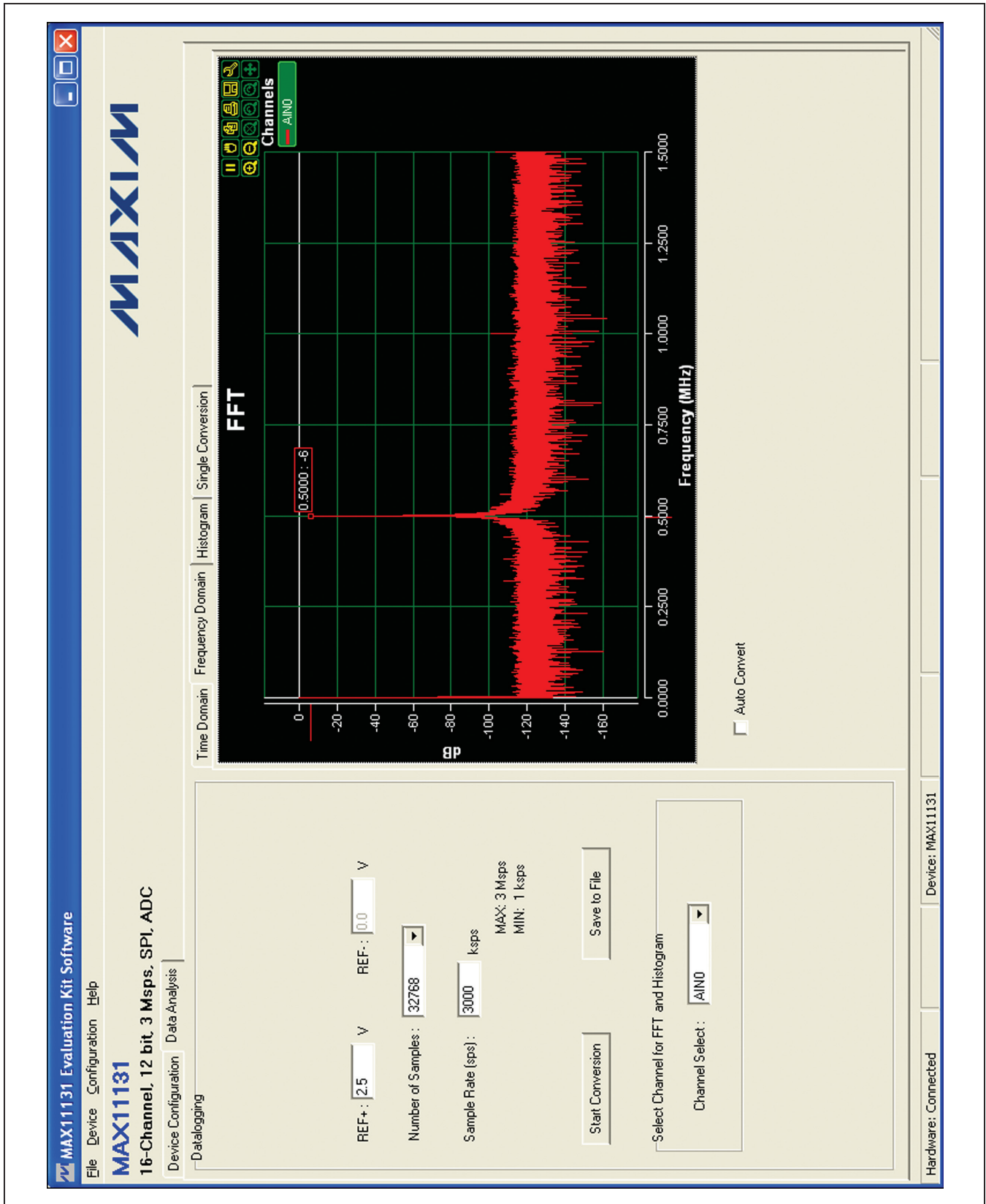

Figure 5. Frequency Domain Tab

MAX11131 Evaluation Kit

Evaluates: MAX11131

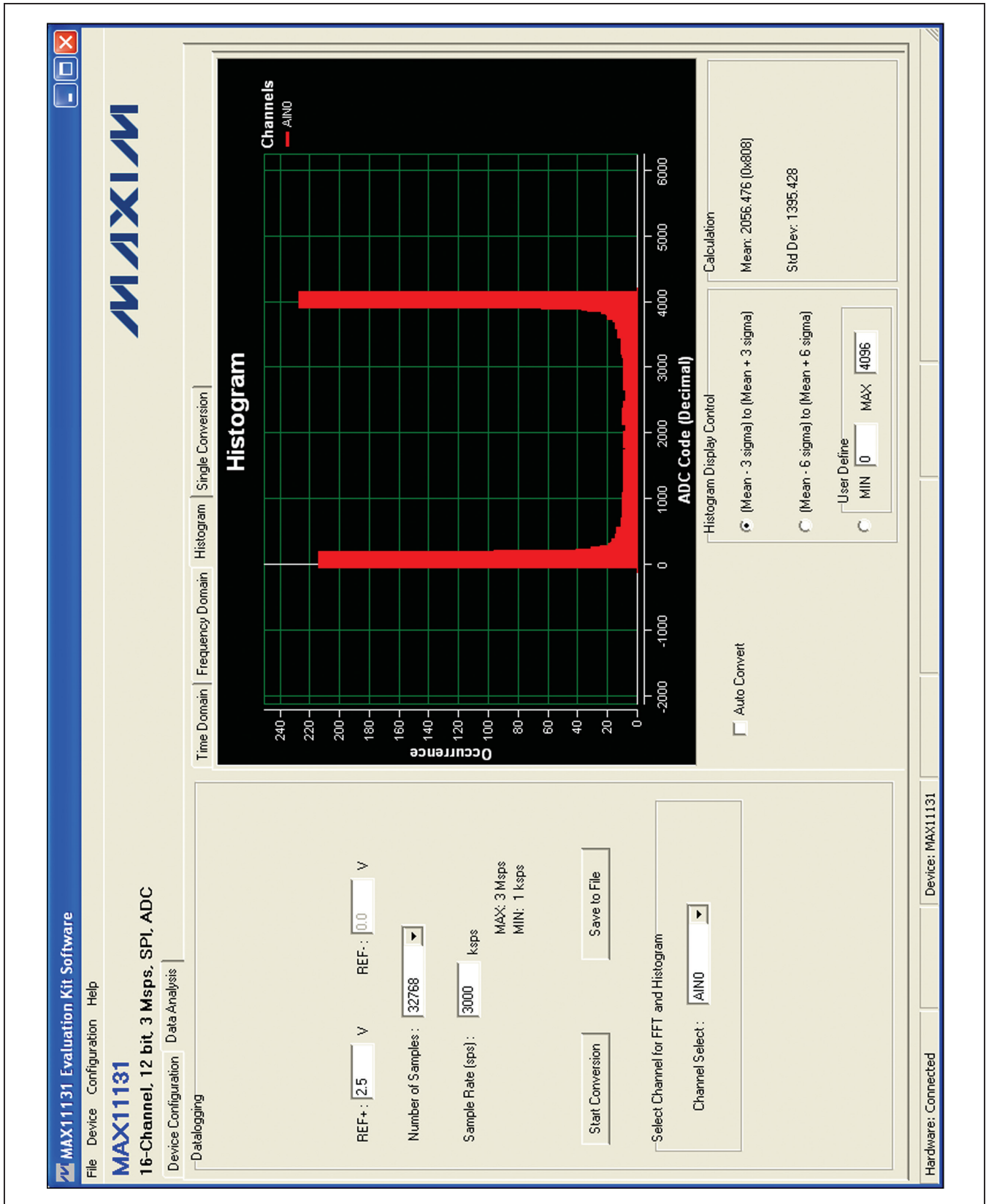

Figure 6. Histogram Tab

MAX1131 Evaluation Kit

Evaluates: MAX1131

MAX1131 Evaluation Kit Software
 File Device Configuration Help
MAX1131
 16-Channel, 12 bit, 3 Msps, SPI, ADC
 Device Configuration Data Analysis
 Data Logging

REF+: 2.5 V REF-: 0.0 V
 Number of Samples: 8192
 Sample Rate (sps): 3000 kspss
 Actual Rate: 3000.00 kspss
 MAX: 3 Msps
 MIN: 1 kspss

Start Conversion Save to File

Select Channel for FFT and Histogram
 Channel Select: AIN0

Time Domain | Frequency Domain | Histogram | Single Conversion

ADC Value Display

AIN0	AIN1	AIN2	AIN3	AIN4	AIN5	AIN6	AIN7	AIN8	AIN9	AIN10	AIN11	AIN12	AIN13	AIN14	AIN15
Code: 0x7E9	Code: 0x6EB	Code: 0x5EE	Code: 0x4F0	Code: 0x3F2	Code: 0x2F6	Code: 0x1FA	Code: 0x0FF	Code: 0x7E9	Code: 0x6EB	Code: 0x5EE	Code: 0x4F0	Code: 0x3F2	Code: 0x2F6	Code: 0x1FA	Code: 0x0FF
Voltage: 1.2360V	Voltage: 1.0809V	Voltage: 0.9265V	Voltage: 0.7715V	Voltage: 0.6165V	Voltage: 0.4626V	Voltage: 0.3088V	Voltage: 0.1556V	Voltage: 2.4994V	Voltage: 2.3309V	Voltage: 2.1729V	Voltage: 2.0148V	Voltage: 1.8585V	Voltage: 1.7023V	Voltage: 1.5472V	Voltage: 1.3916V

Auto Convert

Hardware: Connected Device: MAX1131

Figure 7. Single Conversion Tab

MAX11131 Evaluation Kit

Evaluates: MAX11131

Detailed Description of Hardware

The MAX11131 EV kit is a fully assembled and tested PCB that evaluates the 16-channel, 12-bit, SPI-compatible, 3Msps ADC. All digital signals are generated using the on-board FPGA (U2).

Power Supply

A +5V power supply is required to power up the EV kit. Connect the positive terminal of the power supply to the VIN test point and the negative terminal to the nearest GND test point.

User-Supplied Digital Supply (OVDD)

The digital supply is configurable using jumper JU2. When the shunt is in the 1-2 position on jumper JU2, the on-board +3.3V is used. To use a user-supplied OVDD, move the shunt to the 2-3 position on JU2 and apply +1.5V to +3.6V at the EXT_OVDD test point.

On-Board Input Buffers

On-board input buffers (U8, U9, U16, and U17) are provided on the EV kit. To power the on-board buffers, connect the +5V, GND, and -5V terminals of the power supply to the OP+, GND, and OP- test points, respectively.

Analog Input 0

To use the on-board input buffer, move the shunt on jumper JU17 to the 1-4 position and remove the shunts on jumpers JU25 and JU26.

The user can connect the input signal to the AIN0-_SMA (or the AIN0- test point) and connect the DC offset to the AIN0+ test point. If the input signal is AC-coupling, the DC offset can be accomplished by simply connecting to the 1-2 position on jumper JU21.

The input signal can connect to AIN0+_SMA if it has $V(\text{REF+})/2$ DC offset and is connecting to the 2-3 position on JU21.

Jumper JU17 allows other options for the AIN0 input of the ADC. When a shunt is placed in the 1-2 position on JU17, the analog input can also be generated by the resistor ladder. When a shunt is placed in the 1-3 position on JU17, the analog input signal can be applied at the header H1-2 pin.

Move the shunt on jumper JU17 to the 1-5 position and connect the measuring signal directly to the AIN0 input of the ADC. Then connect the measuring signal to the AIN0+_SMA or AIN0+ test point. The buffer still needs to be powered up to prevent loading on the input signal.

Analog Input 1

To use the on-board input buffer, move the shunt on jumper JU18 to the 1-4 position and remove the shunts on jumpers JU27 and JU28.

The user can connect the input signal to the AIN1-_SMA (or the AIN1- test point) and connect the DC offset to the AIN1+ test point. If the input signal is AC-coupling, the DC offset can be accomplished by simply connecting to the 1-2 position on jumper JU22.

The input signal can connect to AIN1+_SMA if it has $V(\text{REF+})/2$ DC offset and is connecting to the 2-3 position on JU22.

Jumper JU18 allows other options for the AIN1 input of the ADC. When a shunt is placed in the 1-2 position on JU18, the analog input can also be generated by the resistor ladder. When a shunt is placed in the 1-3 position on JU18, the analog input signal can be applied at the header H1-4 pin.

Move the shunt on JU18 to the 1-5 position and connect the measuring signal directly to the AIN1 input of the ADC. Then connect the measuring signal to the AIN1+_SMA or AIN1+ test point. The buffer still needs to be powered up to prevent loading on the input signal.

Analog Input 2

To use the on-board input buffer, move the shunt on jumper JU19 to the 1-4 position and remove the shunts on jumpers JU29 and JU30.

The user can connect the input signal to the AIN2-_SMA (or the AIN2- test point) and connect the DC offset to the AIN2+ test point. If the input signal is AC-coupling, the DC offset can be accomplished by simply connecting to the 1-2 position on JU23.

The input signal can connect to AIN2+_SMA if it has $V(\text{REF+})/2$ DC offset and is connecting to the 2-3 position on JU23.

Jumper JU19 allows other options for the AIN2 input of the ADC. When a shunt is placed in the 1-2 position on JU19, the analog input can also be generated by the resistor ladder. When a shunt is placed in the 1-3 position on JU19, the analog input signal can be applied at the header H1-6 pin.

Move the shunt on JU19 to the 1-5 position and connect the measuring signal directly to the AIN2 input of the ADC. Then connect the measuring signal to the AIN2+_SMA or AIN2+ test point. The buffer still needs to be powered up to prevent loading on the input signal.

MAX11131 Evaluation Kit

Evaluates: MAX11131

Analog Input 3

To use the on-board input buffer, move the shunt on jumper JU20 to the 1-4 position and remove the shunts on jumpers JU31 and JU32.

The user can connect the input signal to the AIN3-_SMA (or the AIN3- test point) and connect the DC offset to the AIN3+ test point. If the input signal is AC-coupling, the DC offset can be accomplished by simply connecting to the 1-2 position on jumper JU24.

The input signal can connect to AIN3+_SMA if it has V(REF+)/2 DC offset and is connecting to the 2-3 position on JU24.

Jumper JU20 allows other options for the AIN3 input of the ADC. When a shunt is placed in the 1-2 position on jumper JU20, the analog input can also be generated by the resistor ladder. When a shunt is placed in the 1-3 position on JU20, the analog input signal can be applied at the header H1-8 pin.

Move the shunt on JU20 to the 1-5 position and connect the measuring signal directly to the AIN3 input of the ADC. Then connect the measuring signal to the AIN3+_SMA or AIN3+ test point. The buffer still needs to be powered up to prevent loading on the input signal.

Analog Inputs 4–15

Analog inputs 4–15 have only two jumper options: connection to the H1 header or to the resistor ladder. See Table 1 for jumpers JU4–JU13, JU15, and JU16 settings. When using the resistor ladder option, a reference voltage must be applied at the REF+ pin of the IC.

Crosstalk on Analog Inputs

When an AC signal is applied at the analog inputs 0–3, the EV kit sees some crosstalk across the other channels (4–15) that are connected to the resistor ladder. The impedance on the resistor ladder is too high to discharge the input capacitors of the channels and causes crosstalk on the channels.

Use resistor ladder is for functional evaluation only. The input source impedance must not be more than 10Ω to guarantee the performance or avoid crosstalk.

Coherent Sampling Setup Using 10MHz EXT CLK

The EV kit provides a 10MHz clock to let the user perform coherent sampling by synchronizing the input source with this clock. Coherent sampling is required to get

the best performance out of the part. The relationship between f_{in} , f_s , N_{cycles} , and $M_{samples}$ is given as follows:

$$\frac{f_{in}}{f_s} = \frac{N_{cycles}}{M_{samples}}$$

where:

f_{in} = Input frequency

f_s = Sampling frequency

N_{cycles} = Number of cycles in the sampled set

$M_{samples}$ = Total number of samples

In this case, set f_{in} as 499.9694kHz for 32,768 samples to get 5461 cycles at 3Msps. Figure 5 shows the FFT of the signal.

Conversion Start (CNVST)

When analog input 14 is not used, remove the shunt from jumper JU15 and apply an active-low signal to the CNVST test point to start the conversion.

Negative Reference Voltage (REF-)

When analog input 15 is not used, remove the shunt from jumper JU16 and apply -0.3V to +1V to the REF- test point.

Positive Reference Voltage (REF+)

There are three options for the positive reference voltage. When the shunt is in the 1-2 position on jumper JU3, the user must apply an external reference voltage from +1V to $V_{DD} + 50mV$ at the EXT_REF+ test point. The EV kit also features two on-board references (2.5V and 2.048V) when JU3 is in the 1-3 and 1-4 position.

User-Supplied Supply (VDD)

The IC can be powered using the on-board supply or a user-supplied VDD. When the shunt is in the 1-2 position on jumper JU1, the on-board +3.3V is used. To use a user-supplied VDD, move the shunt to the 2-3 position on JU1 and apply +2.35V to +3.6V at the EXT_VDD test point.

User-Supplied Digital Supply (OVDD)

The digital supply can use the on-board supply or a user-supplied OVDD. When the shunt is in the 1-2 position on jumper JU2, the on-board +3.3V is used. To use a user-supplied OVDD, move the shunt to the 2-3 position on JU2 and apply +1.5V to +3.6V at the EXT_OVDD test point.

MAX11131 Evaluation Kit

Evaluates: MAX11131

Table 1. Jumper Settings (JU1–JU32 and JU35–JU44)

JUMPER	SHUNT POSITION	DESCRIPTION
JU1	1-2*	Connects the VDD input of the IC to the output of the on-board +3.3V LDO (U10).
	2-3	User-supplied VDD. Apply an external supply voltage between the EXT_VDD and the nearest GND test point.
JU2	1-2*	Connects the OVDD input of the IC to the output of the on-board +3.3V LDO (U3).
	2-3	User-supplied OVDD. Apply an external supply voltage between the EXT_OVDD and the nearest DGND test point.
JU3	1-2	User-supplied REF+. Apply an external reference voltage between the EXT_REF+ and the nearest GND test point.
	1-3*	Connects the REF+ input of the IC to the output of the on-board +2.5V reference (U19).
	1-4	Connects the REF+ input of the IC to the output of the on-board +2.048V reference (U18).
JU4	1-2*	Connects the voltage generated by the resistor ladder to the AIN4 input of the IC through a 10Ω resistor.
	2-3	Connects H1-10 of header H1 to the AIN4 input of the IC through a 10Ω resistor.
JU5	1-2*	Connects the voltage generated by the resistor ladder to the AIN5 input of the IC through a 10Ω resistor.
	2-3	Connects H1-12 of header H1 to the AIN5 input of the IC through a 10Ω resistor.
JU6	1-2*	Connects the voltage generated by the resistor ladder to the AIN6 input of the IC through a 10Ω resistor.
	2-3	Connects H1-14 of header H1 to the AIN6 input of the IC through a 10Ω resistor.
JU7	1-2*	Connects the voltage generated by the resistor ladder to the AIN7 input of the IC through a 10Ω resistor.
	2-3	Connects H1-16 of header H1 to the AIN7 input of the IC through a 10Ω resistor.
JU8	1-2*	Connects the voltage generated by the resistor ladder to the AIN8 input of the IC through a 10Ω resistor.
	2-3	Connects H1-18 of header H1 to the AIN8 input of the IC through a 10Ω resistor.
JU9	1-2*	Connects the voltage generated by the resistor ladder to the AIN9 input of the IC.
	2-3	Connects H1-20 of header H1 to the AIN9 input of the IC through a 10Ω resistor.
JU10	1-2*	Connects the voltage generated by the resistor ladder to the AIN10 input of the IC through a 10Ω resistor.
	2-3	Connects H1-22 of header H1 to the AIN10 input of the IC through a 10Ω resistor.
JU11	1-2*	Connects voltage generated by the resistor ladder to the AIN11 input of the IC through a 10Ω resistor.
	2-3	Connects H1-24 of header H1 to the AIN11 input of the IC through a 10Ω resistor.
JU12	1-2*	Connects voltage generated by the resistor ladder to the AIN12 input of the IC through a 10Ω resistor.
	2-3	Connects H1-26 of header H1 to the AIN12 input of the IC through a 10Ω resistor.
JU13	1-2*	Connects the voltage generated by the resistor ladder to the AIN13 input of the IC through a 10Ω resistor.
	2-3	Connects H1-28 of header H1 to the AIN13 input of the IC through a 10Ω resistor.
JU14	1-2	Connects the CNVST input of the IC to the GPIO signal driven by the FPGA (U2).
	2-3*	Used for AIN14.
JU15	1-2*	Connects the voltage generated by the resistor ladder to the AIN14 input of the IC through a 10Ω resistor.
	2-3	Connects H1-30 of header H1 to the AIN14 input of the IC through a 10Ω resistor.

MAX11131 Evaluation Kit

Evaluates: MAX11131

Table 1. Jumper Settings (JU1–JU32 and JU35–JU44) (continued)

JUMPER	SHUNT POSITION	DESCRIPTION
JU16	1-2*	Connects voltage generated by the resistor ladder to the AIN15 input of the IC through a 10Ω resistor.
	2-3	Connects H1-32 of header H1 to the AIN15 input of the IC through a 10Ω resistor.
	Not installed	Apply negative reference voltage at the REF- test point.
JU17	1-2*	Connects voltage generated by the resistor ladder to the AIN0 input of the IC through a 10Ω resistor.
	1-3	Connects H1-2 of header H1 to the AIN0 input of the IC through a 10Ω resistor.
	1-4	Connects output of the on-board input buffer (U8) to the AIN0 input of the IC through a 10Ω resistor.
	1-5	Bypasses the on-board input buffer (U8). Connects the AIN0+ test point to the AIN0 input of the IC through a 10Ω resistor.
JU18	1-2*	Connects voltage generated by the resistor ladder to the AIN1 input of the IC through a 10Ω resistor.
	1-3	Connects H1-4 of header H1 to the AIN1 input of the IC through a 10Ω resistor.
	1-4	Connects output of the on-board input buffer (U9) to the AIN1 input of the IC through a 10Ω resistor.
	1-5	Bypasses the on-board input buffer (U9). Connects the AIN1+ test point to the AIN1 input of the IC through a 10Ω resistor.
JU19	1-2*	Connects voltage generated by the resistor ladder to the AIN2 input of the IC through a 10Ω resistor.
	1-3	Connects H1-6 of header H1 to the AIN2 input of the IC through a 10Ω resistor.
	1-4	Connects output of the on-board input buffer (U16) to the AIN2 input of the IC through a 10Ω resistor.
	1-5	Bypasses the on-board input buffer (U16). Connects the AIN2+ test point to the AIN2 input of the IC through a 10Ω resistor.
JU20	1-2*	Connects voltage generated by the resistor ladder to the AIN3 input of the IC through a 10Ω resistor.
	1-3	Connects H1-8 of header H1 to the AIN3 input of the IC through a 10Ω resistor.
	1-4	Connects output of the on-board input buffer (U17) to the AIN3 input of the IC through a 10Ω resistor.
	1-5	Bypasses the on-board input buffer (U17). Connects the AIN3+ test point to the AIN3 input of the IC through a 10Ω resistor.
JU21	1-2	Connects the reference voltage REF+ to the AIN0+ test point.
	2-3*	Connected the AIN0+_SMA connector to the AIN0+ test point.
JU22	1-2	Connects the reference voltage REF+ to the AIN1+ test point.
	2-3*	Connected the AIN1+_SMA connector to the AIN1+ test point.
JU23	1-2	Connects the reference voltage REF+ to the AIN2+ test point.
	2-3*	Connected the AIN2+_SMA connector to the AIN2+ test point.
JU24	1-2	Connects the reference voltage REF+ to the AIN3+ test point.
	2-3*	Connected the AIN3+_SMA connector to the AIN3+ test point.
JU25	Installed	Shorts the DC signal input to GND.
	Not installed*	Connects the signal from the AIN0+ test point to the noninverting of the on-board buffer (U8) through a 1kΩ resistor.

MAX11131 Evaluation Kit

Evaluates: MAX11131

Table 1. Jumper Settings (JU1–JU32 and JU35–JU44) (continued)

JUMPER	SHUNT POSITION	DESCRIPTION
JU26	Installed	Shorts the DC signal input to GND.
	Not installed*	Connects the signal from the AIN0- test point to the inverting of the on-board buffer (U8) through a 1kΩ resistor.
JU27	Installed	Shorts the DC signal input to GND.
	Not installed*	Connects the signal from the AIN1+ test point to the noninverting of the on-board buffer (U9) through a 1kΩ resistor.
JU28	Installed	Shorts the DC signal input to GND.
	Not installed*	Connects the signal from the AIN1- test point to the inverting of the on-board buffer (U9) through a 1kΩ resistor.
JU29	Installed	Shorts the DC signal input to GND.
	Not installed*	Connects the signal from the AIN2+ test point to the noninverting of the on-board buffer (U16) through a 1kΩ resistor.
JU30	Installed	Shorts the DC signal input to GND.
	Not installed*	Connects the signal from the AIN2- test point to the inverting of the on-board buffer (U16) through a 1kΩ resistor.
JU31	Installed	Shorts the DC signal input to GND.
	Not installed*	Connects the signal from the AIN3+ test point to the noninverting of the on-board buffer (U17) through a 1kΩ resistor.
JU32	Installed	Shorts the DC signal input to GND.
	Not installed*	Connects the signal from the AIN3- test point to the inverting of the on-board buffer (U17) through a 1kΩ resistor.
JU35	1-2	Connects the USB power to the input of the on-board LDO (U10).
	2-3*	Connects the external power supply to the input of the on-board LDO (U10).
JU36	1-2	Connects the USB power to the input of the on-board LDO (U11).
	2-3*	Connects the external power supply to the input of the on-board LDO (U11).
JU37	1-2	Connects the USB power to the input of the on-board LDO (U12).
	2-3*	Connects the external power supply to the input of the on-board LDO (U12).
JU38	1-2	Connects the USB power to the input of the on-board LDO (U13).
	2-3*	Connects the external power supply to the input of the on-board LDO (U13).
JU39	1-2	Connects the USB power to the input of the on-board LDO (U3).
	2-3*	Connects the external power supply to the input of the on-board LDO (U3).
JU40	Installed*	The on-board LDO (U10) provides 3.3V output to the EV kit.
	Not installed	Disconnects the output of the on-board LDO (U10).
JU41	Installed*	The on-board LDO (U11) provides 1.8V output to the EV kit.
	Not installed	Disconnects the output of the on-board LDO (U11).
JU42	Installed*	The on-board LDO (U12) provides 2.5V output to the EV kit.
	Not installed	Disconnects the output of the on-board LDO (U12).
JU43	Installed*	The on-board LDO (U13) provides 1.2V output to the EV kit.
	Not installed	Disconnects the output of the on-board LDO (U13).
JU44	Installed*	The on-board LDO (U3) provides 3.3V output to the EV kit.
	Not installed	Disconnects the output of the on-board LDO (U3).

MAX11131 Evaluation Kit

Evaluates: MAX11131

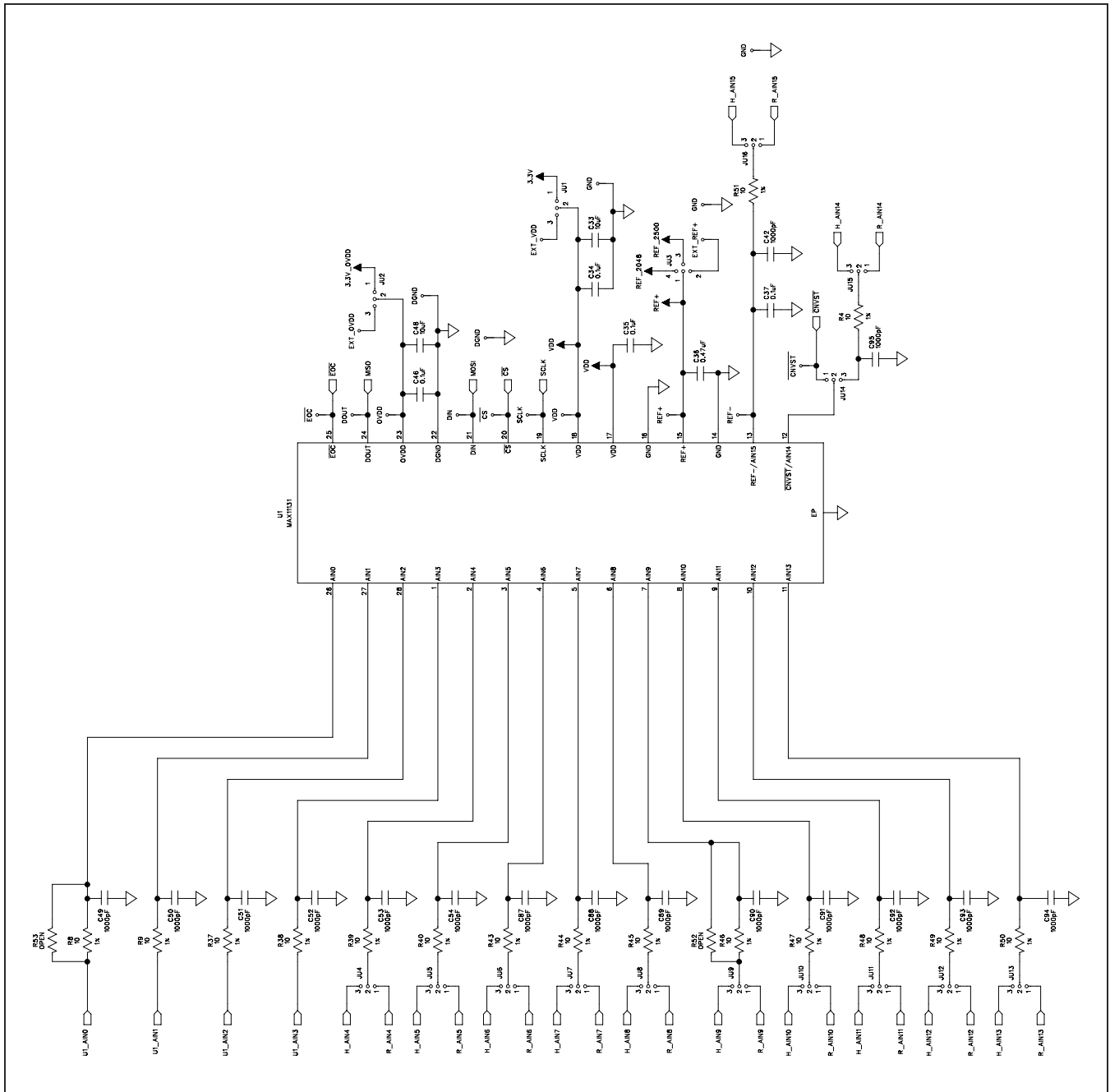

Figure 8a. MAX11131 EV Kit Schematic (Sheet 1 of 14)

MAX11131 Evaluation Kit

Evaluates: MAX11131

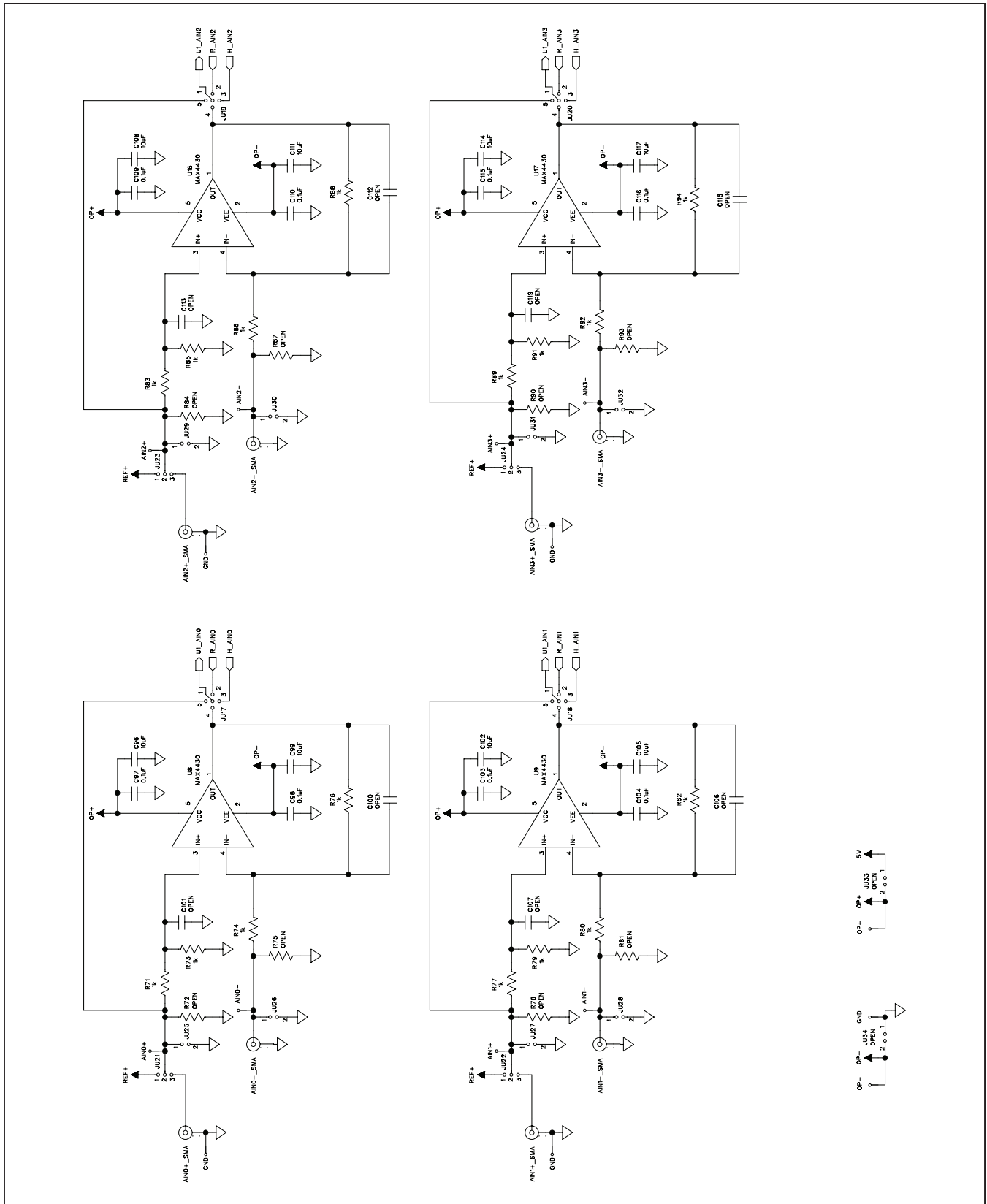

Figure 8b. MAX11131 EV Kit Schematic (Sheet 2 of 14)

MAX11131 Evaluation Kit

Evaluates: MAX11131

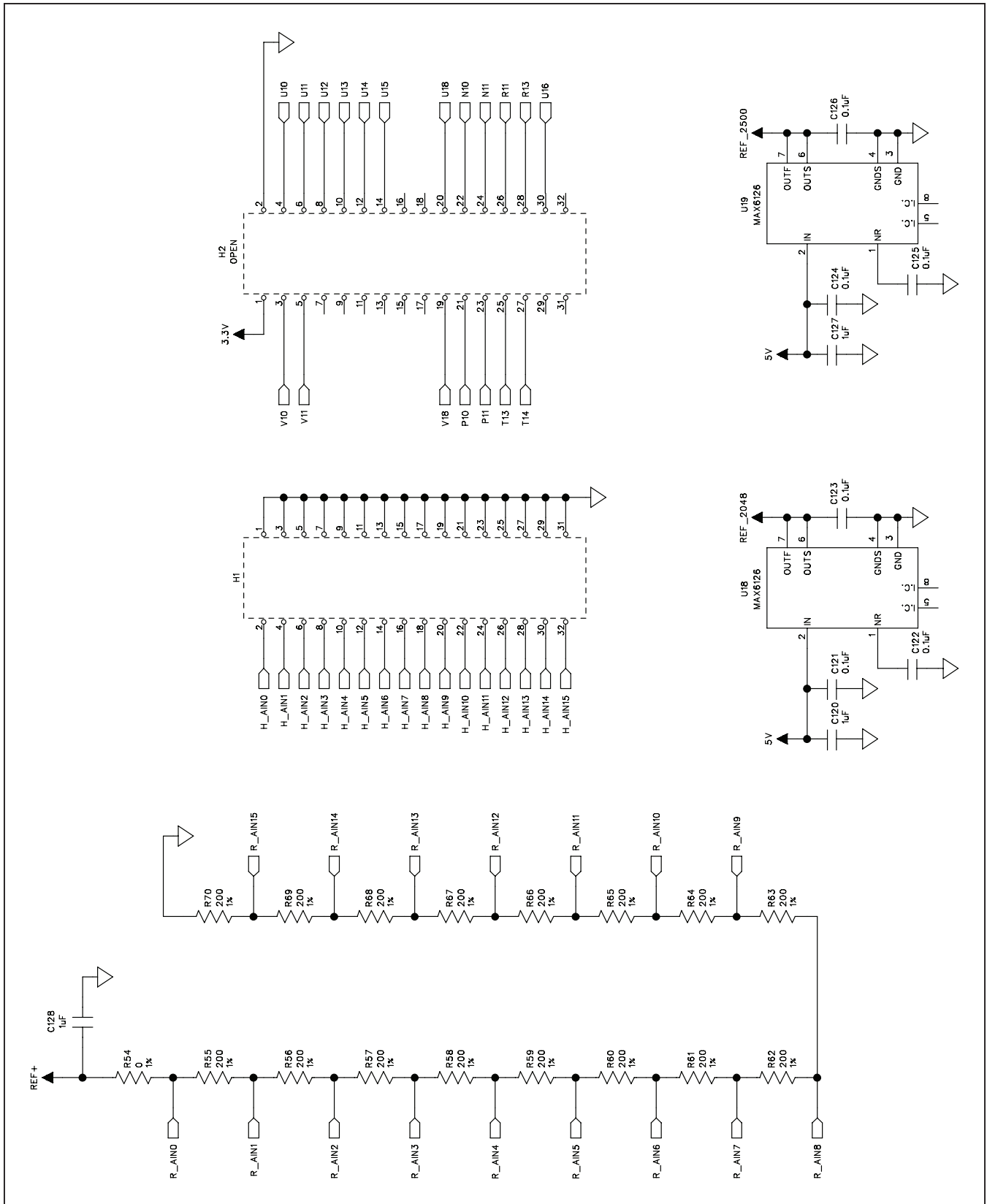

Figure 8c. MAX11131 EV Kit Schematic (Sheet 3 of 14)

MAX11131 Evaluation Kit

Evaluates: MAX11131

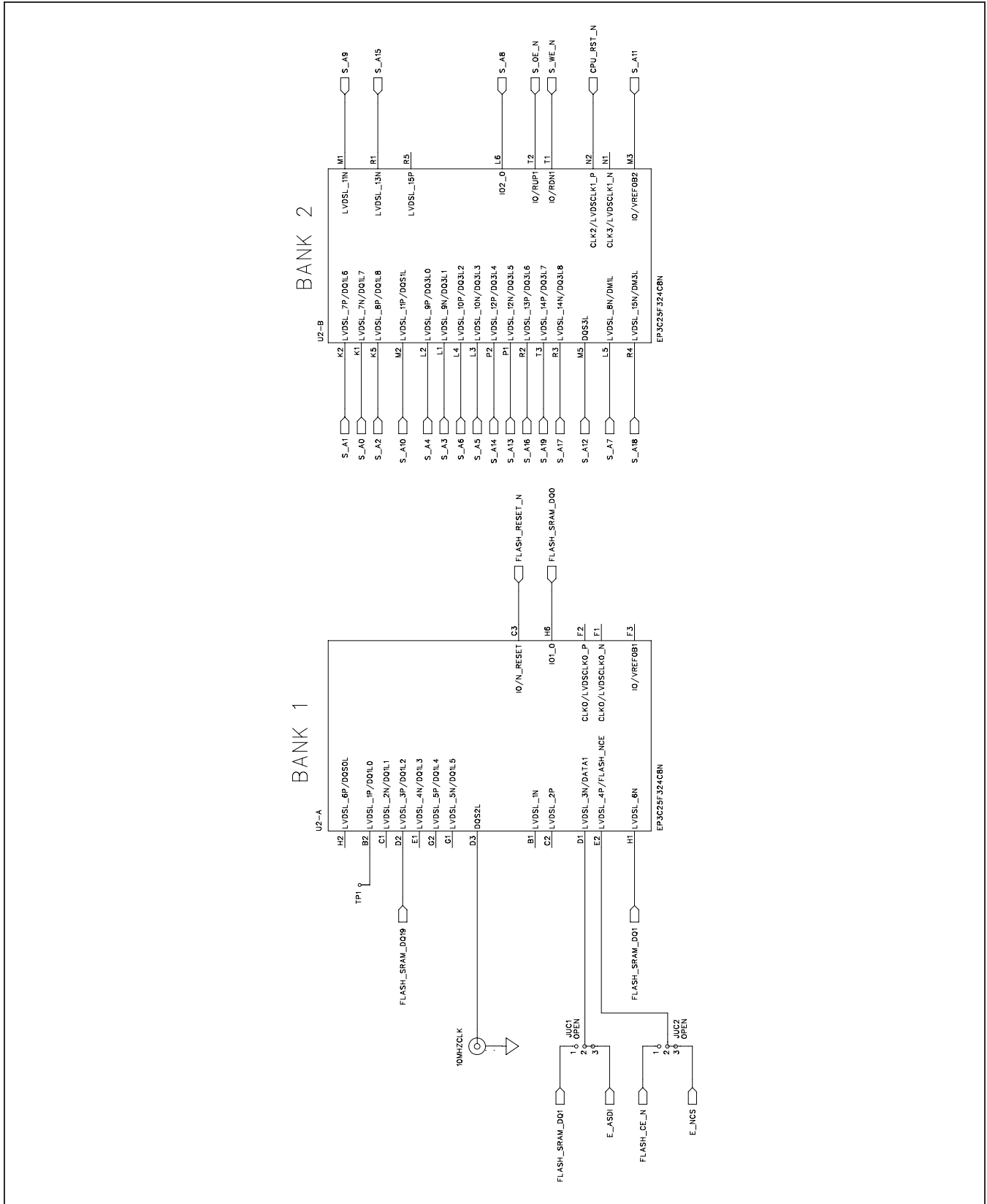

Figure 8d. MAX11131 EV Kit Schematic (Sheet 4 of 14)

MAX11131 Evaluation Kit

Evaluates: MAX11131

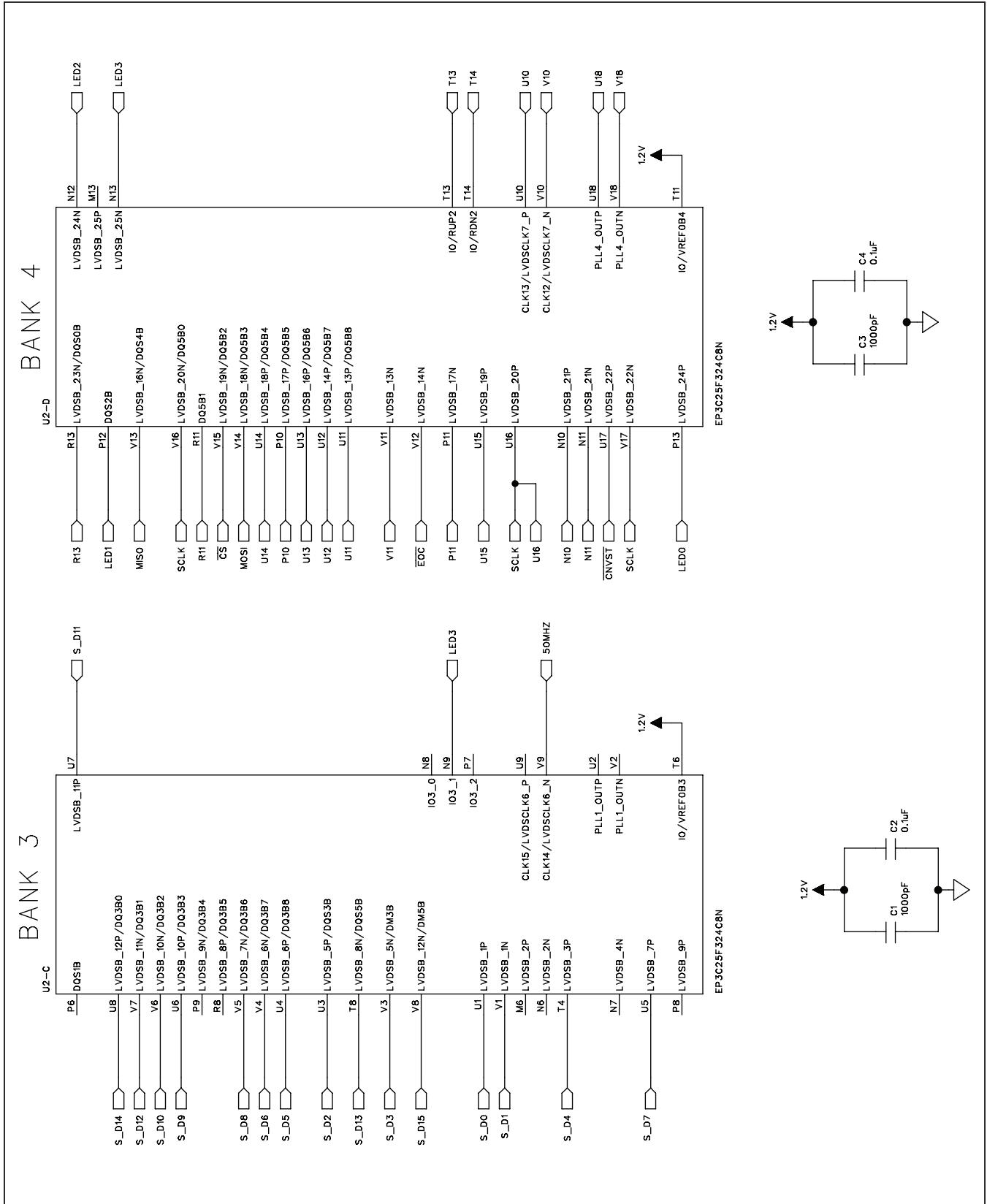

Figure 8e. MAX11131 EV Kit Schematic (Sheet 5 of 14)

MAX11131 Evaluation Kit

Evaluates: MAX11131

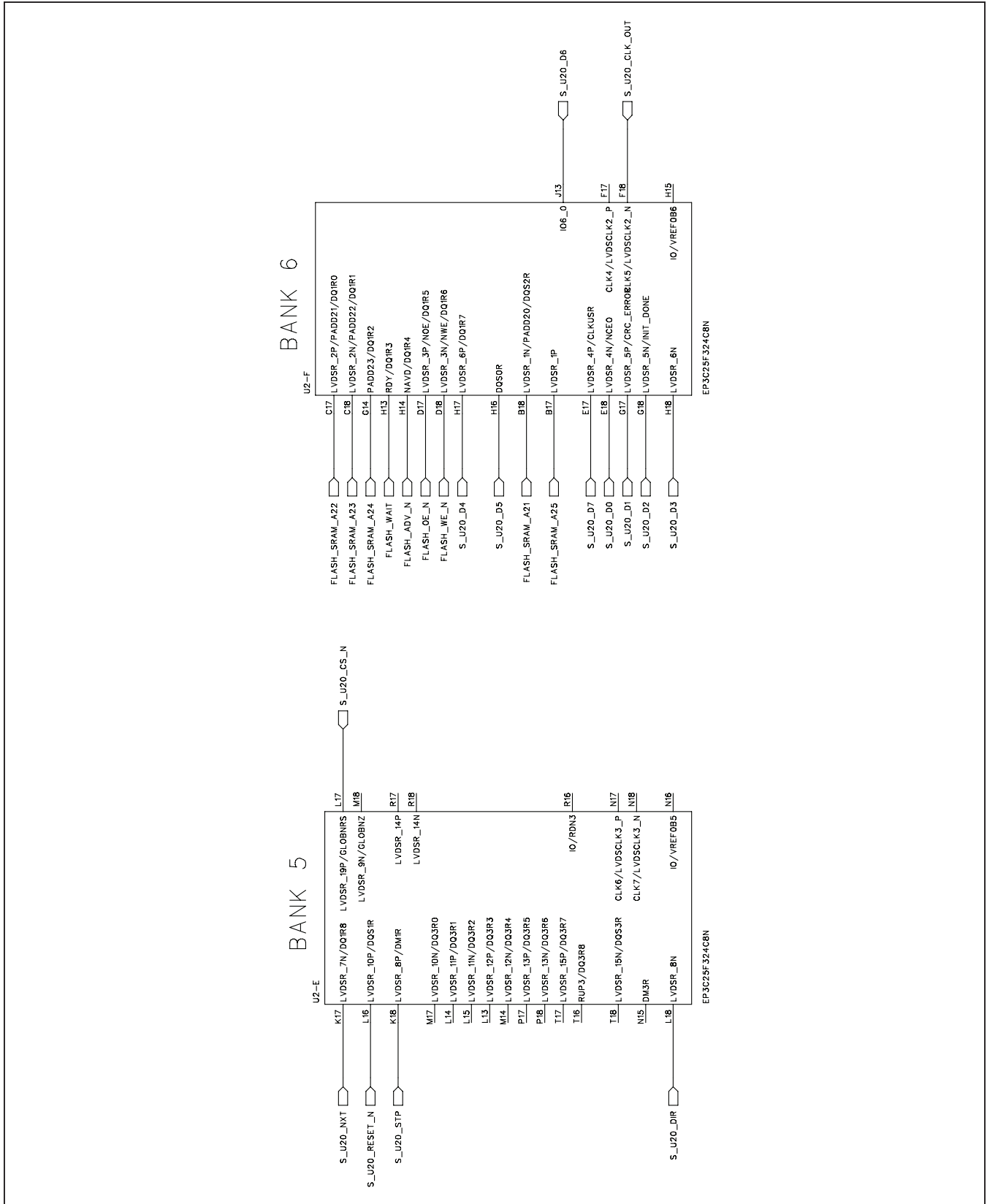

Figure 8f. MAX11131 EV Kit Schematic (Sheet 6 of 14)

MAX11131 Evaluation Kit

Evaluates: MAX11131

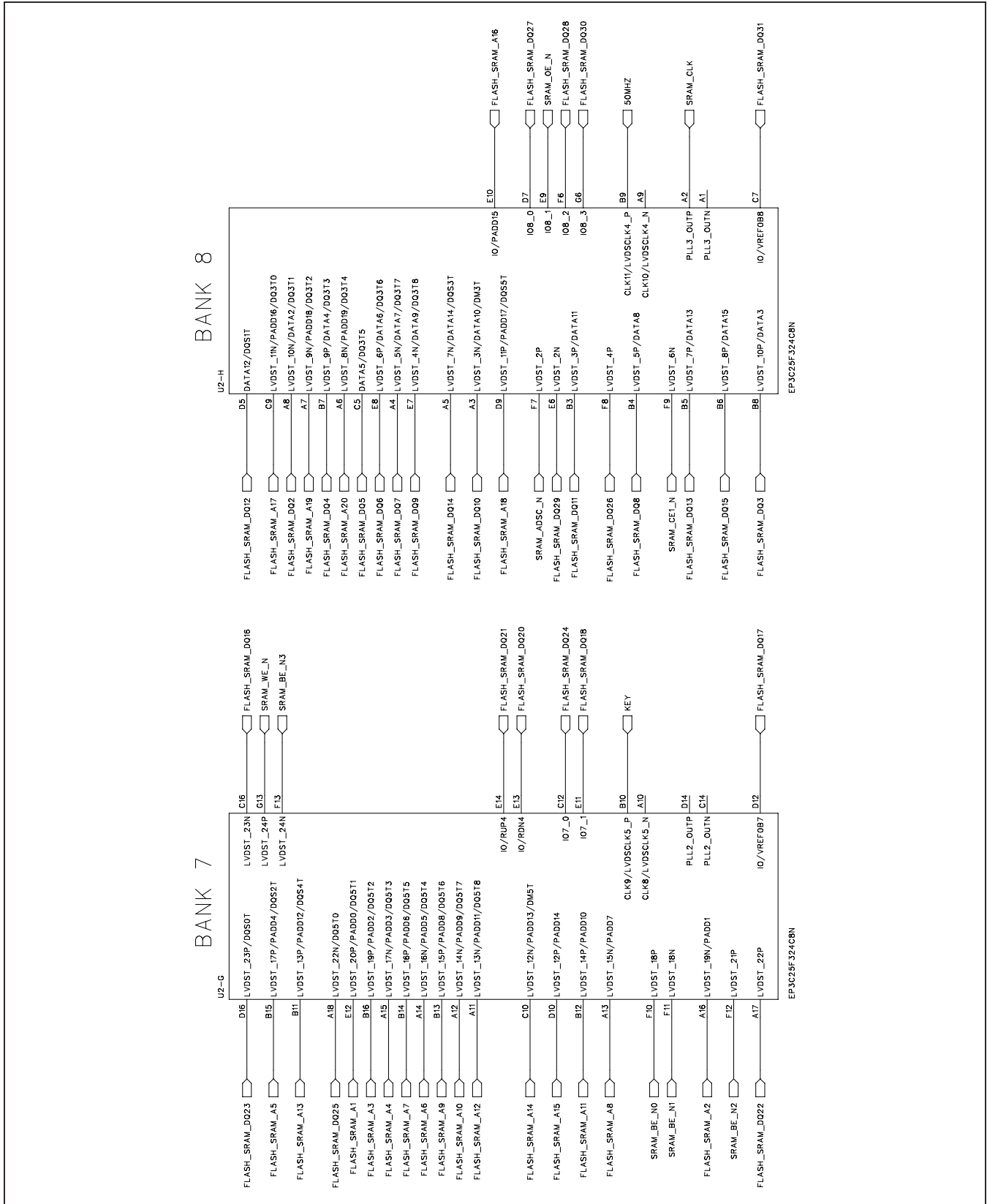

Figure 8g. MAX11131 EV Kit Schematic (Sheet 7 of 14)

MAX11131 Evaluation Kit

Evaluates: MAX11131

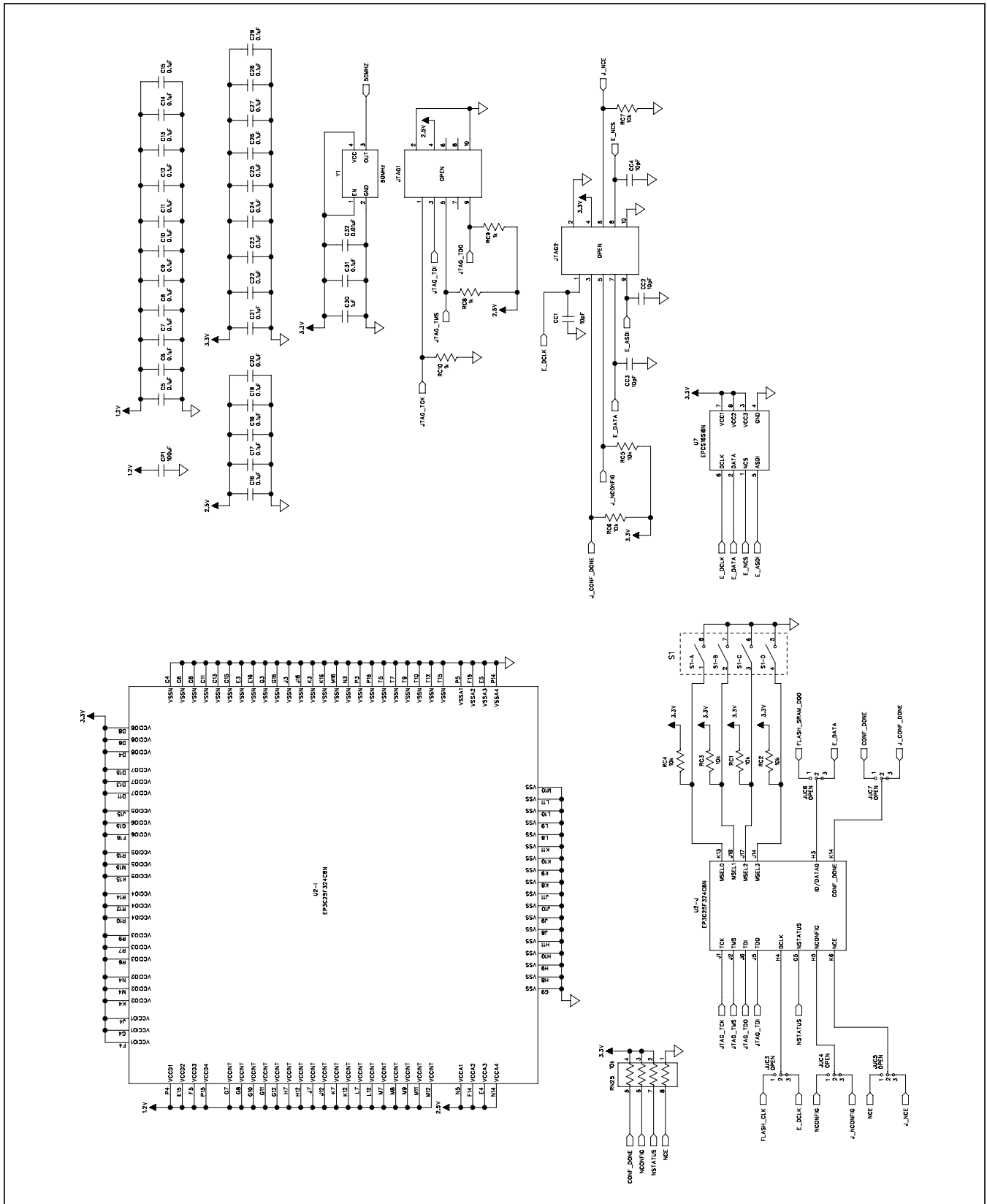

Figure 8h. MAX11131 EV Kit Schematic (Sheet 8 of 14)

MAX1131 Evaluation Kit

Evaluates: MAX1131

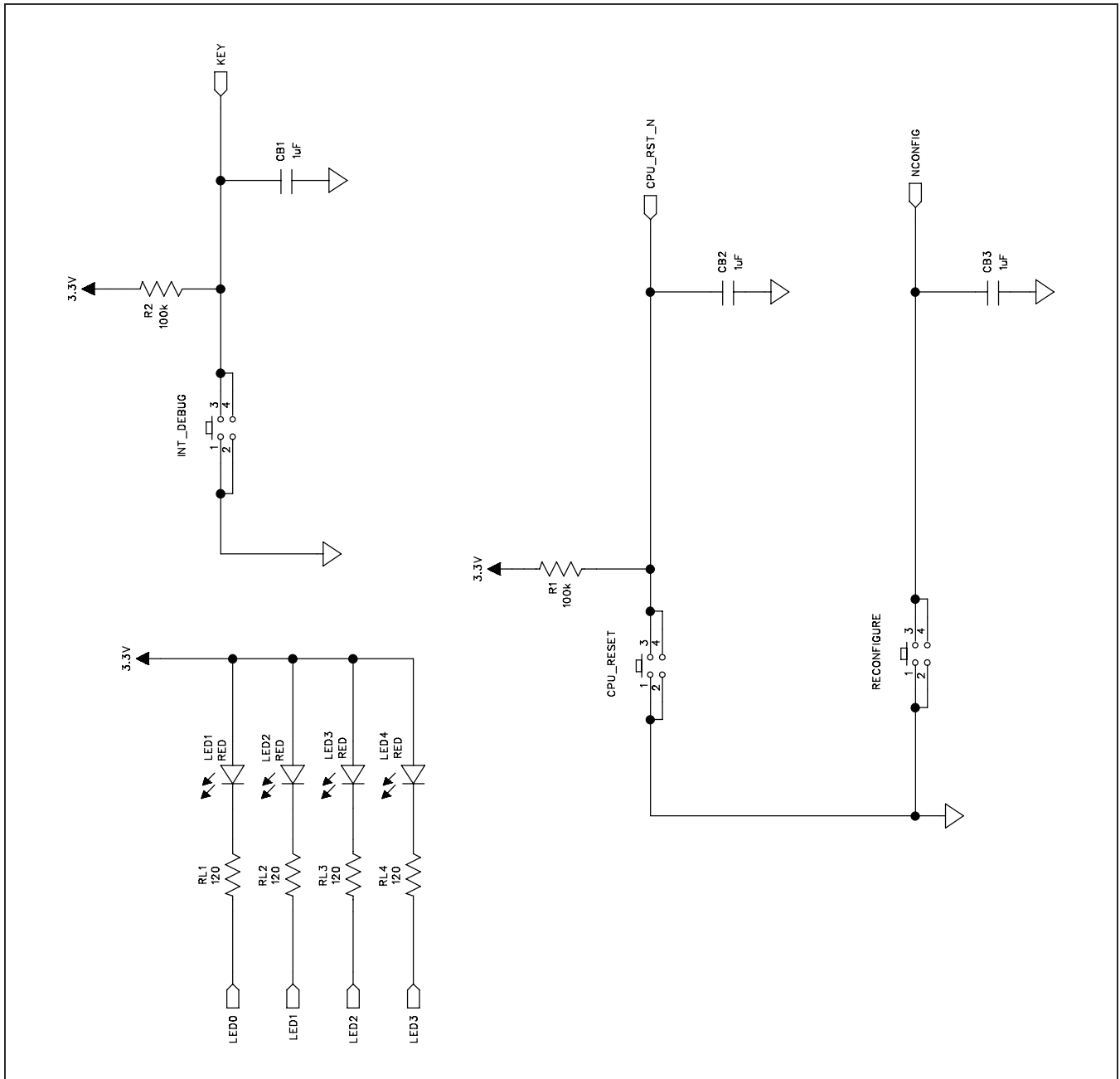

Figure 8i. MAX1131 EV Kit Schematic (Sheet 9 of 14)

MAX11131 Evaluation Kit

Evaluates: MAX11131

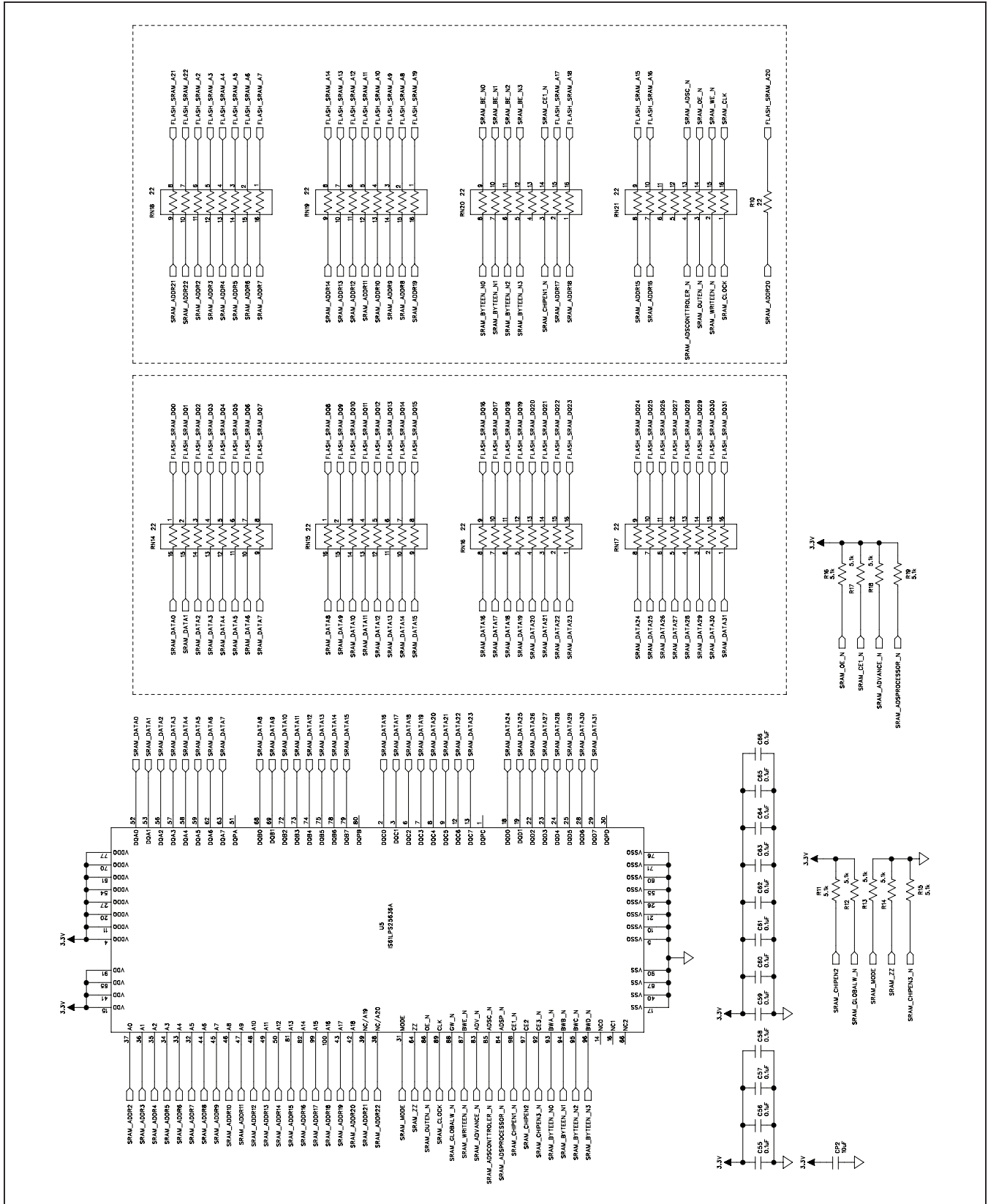

Figure 8j. MAX11131 EV Kit Schematic (Sheet 10 of 14)

MAX11131 Evaluation Kit

Evaluates: MAX11131

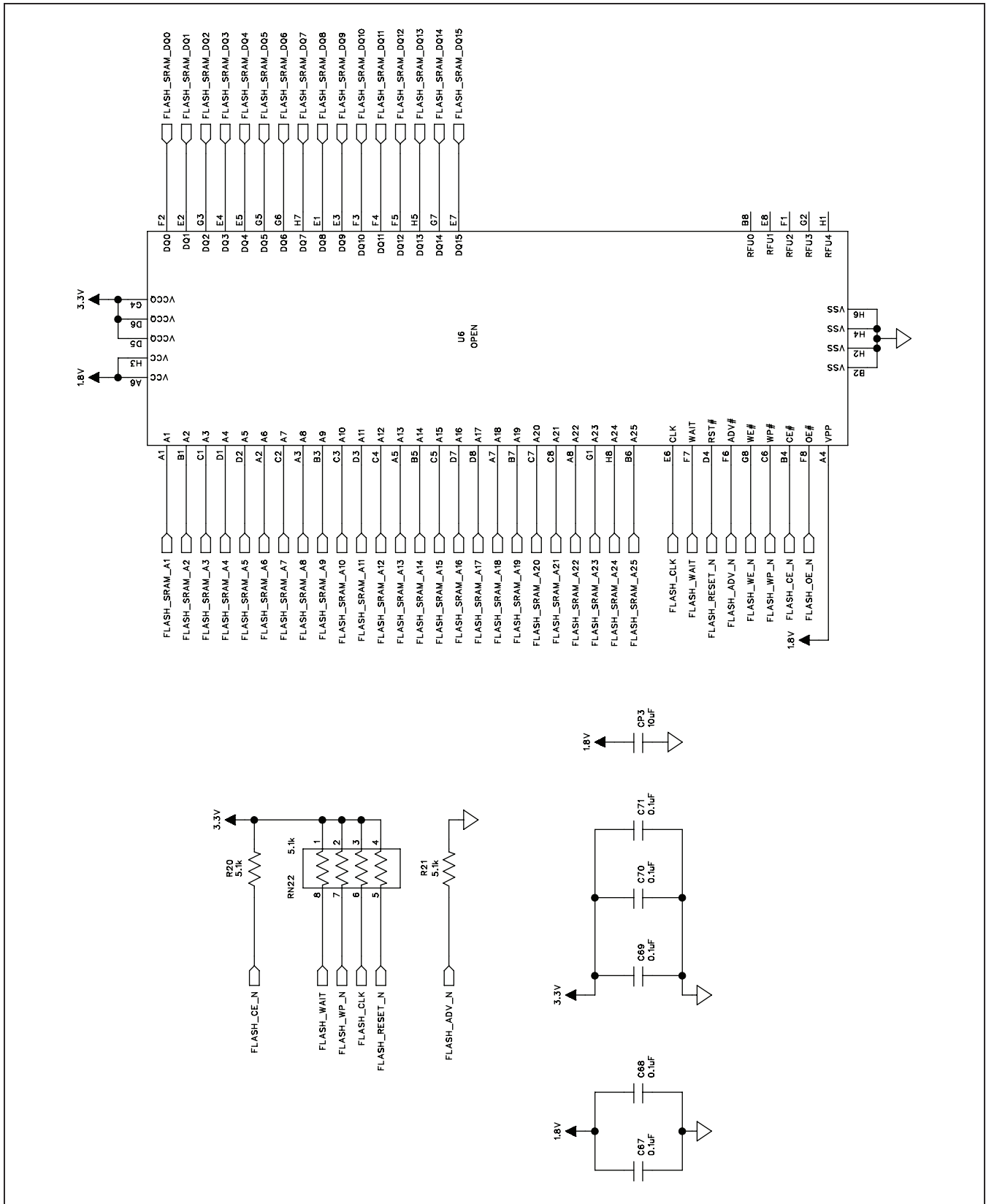

Figure 8k. MAX11131 EV Kit Schematic (Sheet 11 of 14)

MAX11131 Evaluation Kit

Evaluates: MAX11131

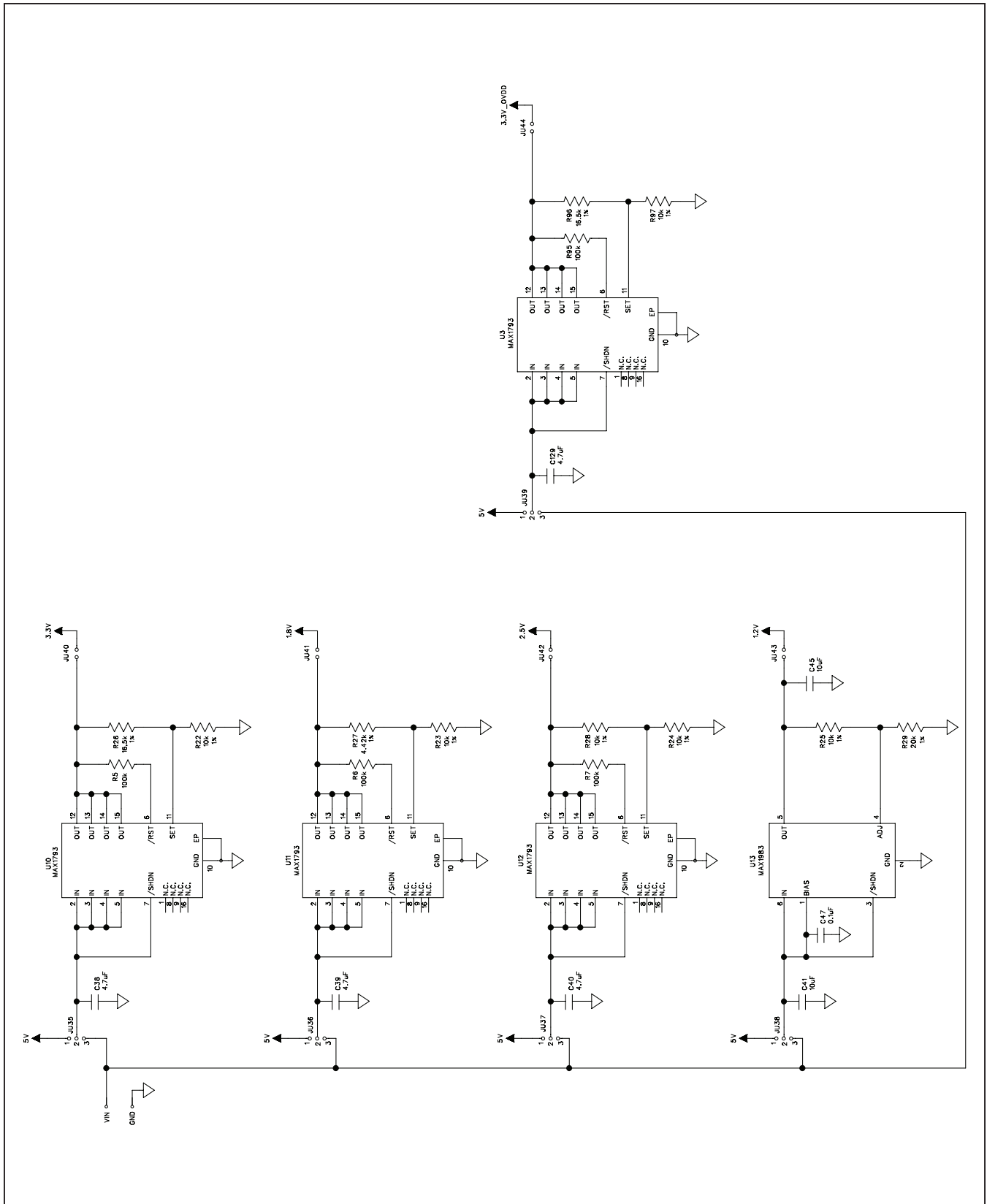

Figure 8m. MAX11131 EV Kit Schematic (Sheet 13 of 14)

MAX11131 Evaluation Kit

Evaluates: MAX11131

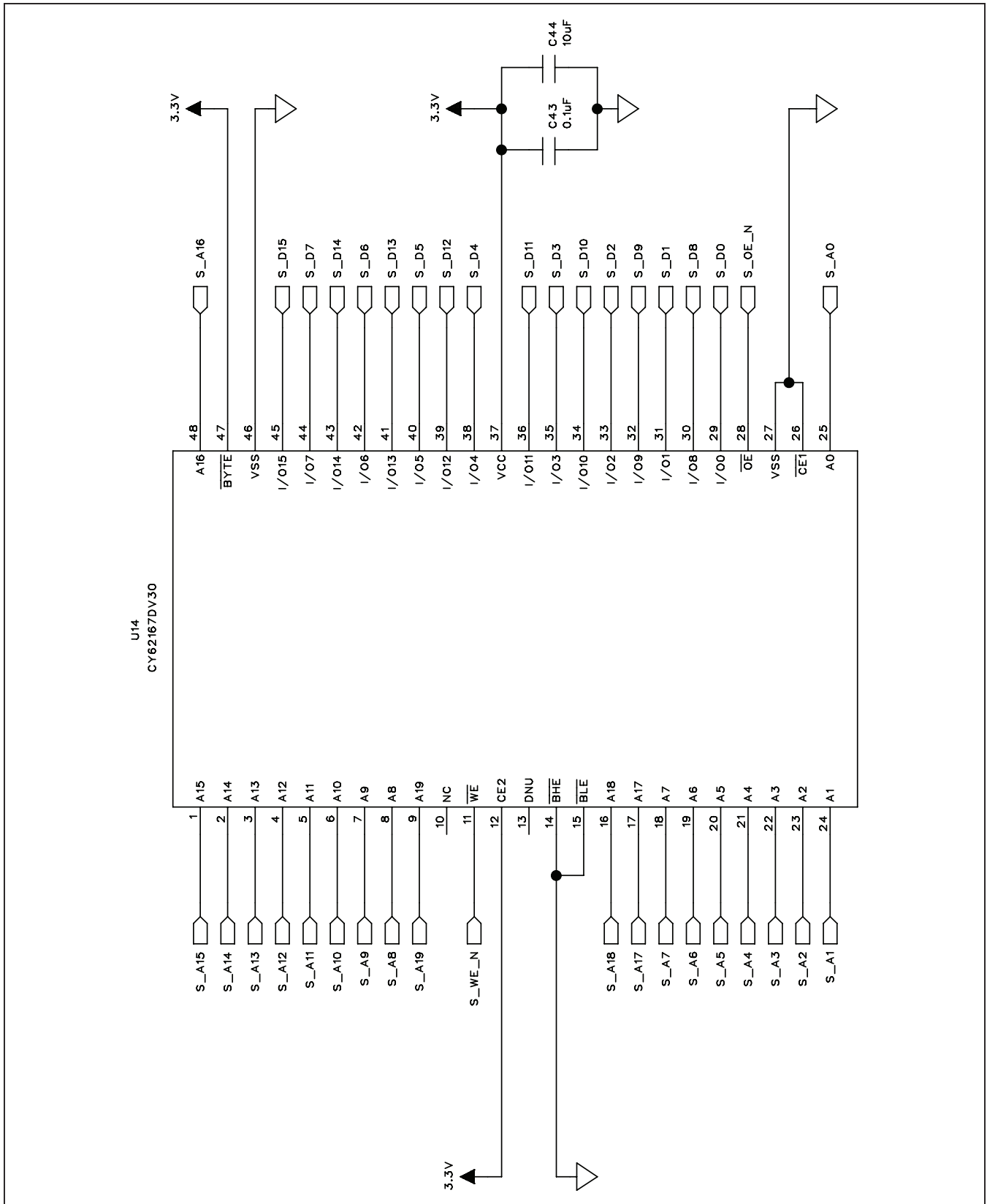

Figure 8n. MAX11131 EV Kit Schematic (Sheet 14 of 14)

MAX11131 Evaluation Kit

Evaluates: MAX11131

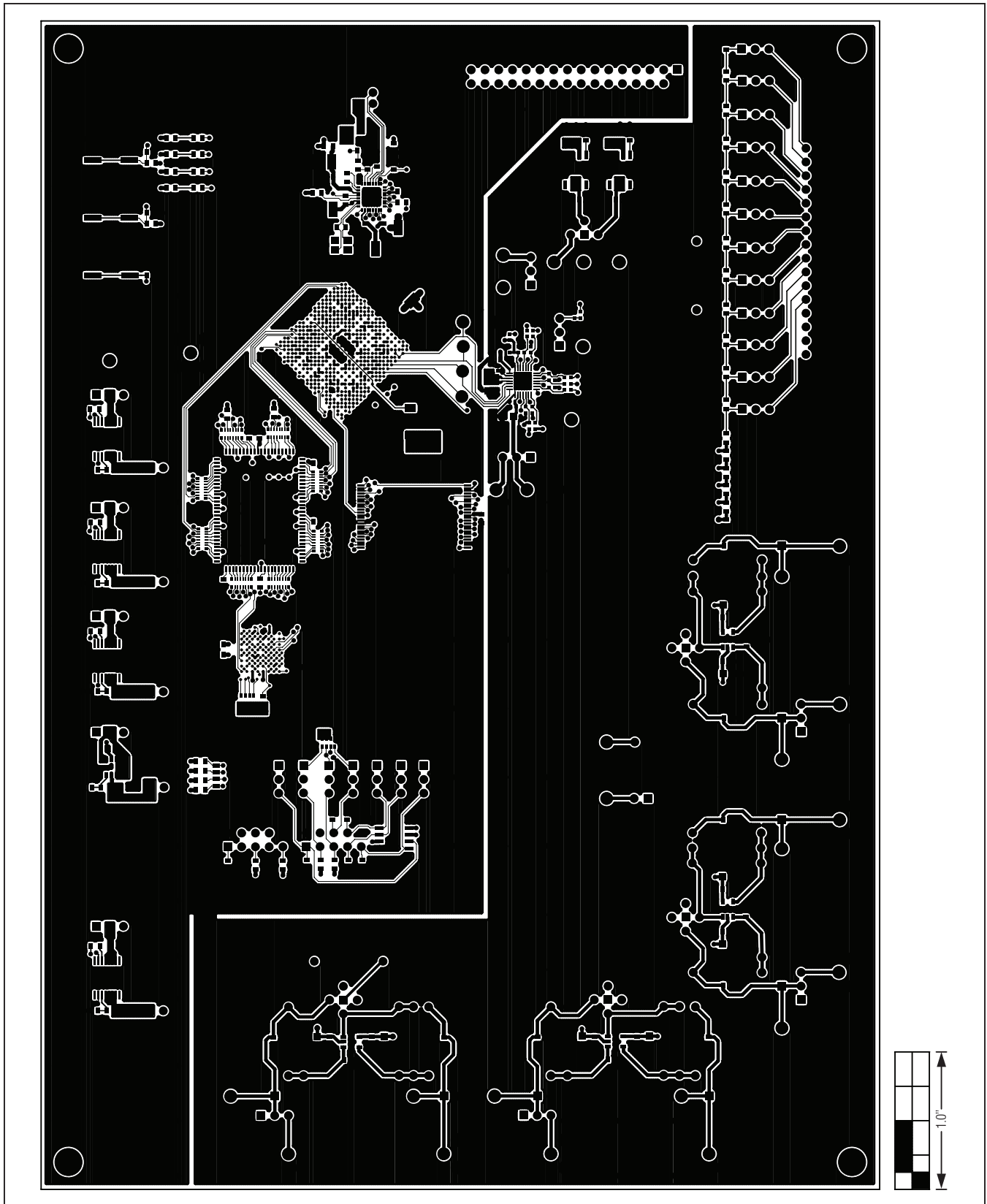

Figure 10. MAX11131 EV Kit PCB Layout—Component Side

MAX11131 Evaluation Kit

Evaluates: MAX11131

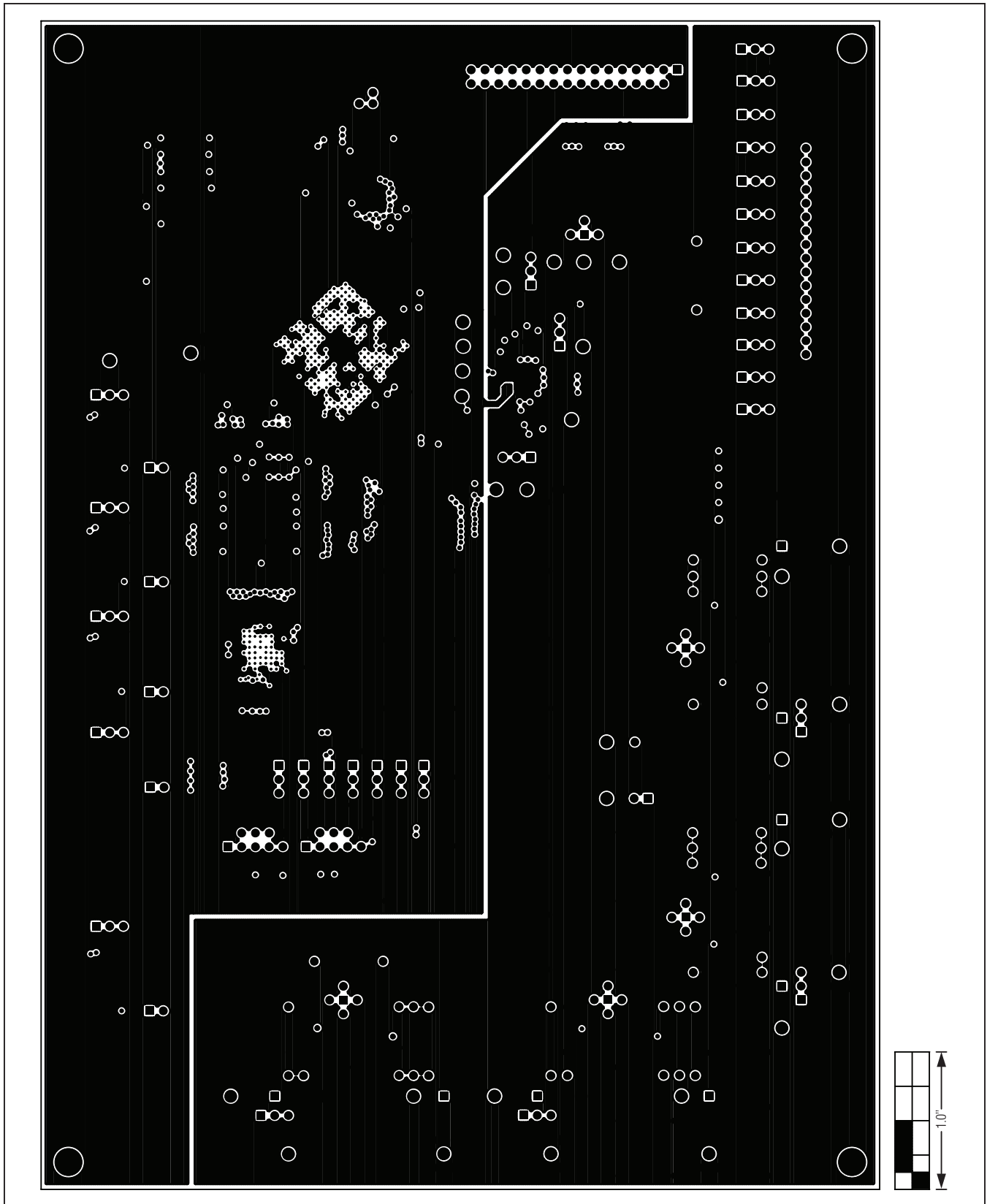

Figure 11. MAX11131 EV Kit PCB Layout—Layer 2

MAX11131 Evaluation Kit

Evaluates: MAX11131

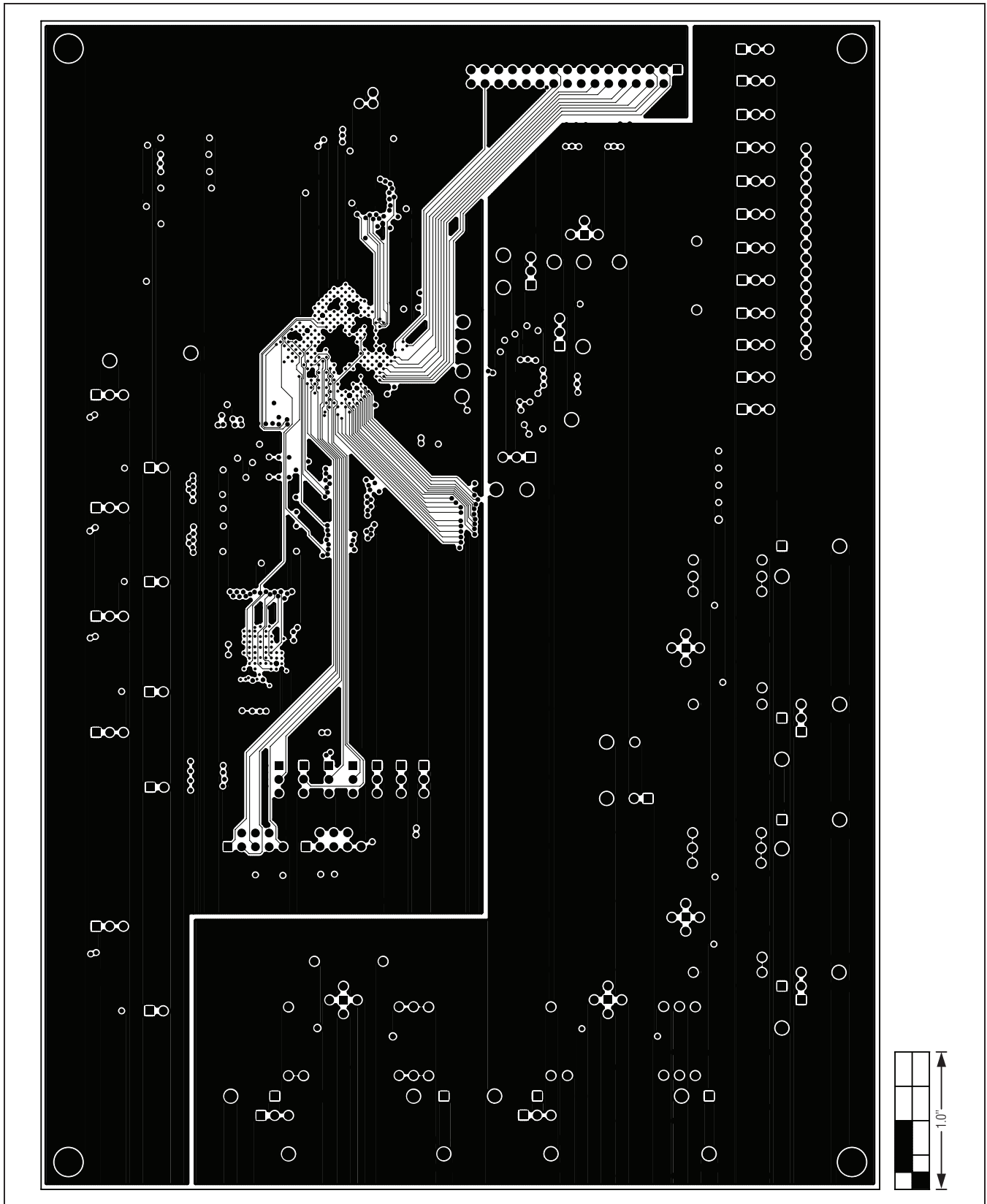

Figure 12. MAX11131 EV Kit PCB Layout—Layer 3

MAX11131 Evaluation Kit

Evaluates: MAX11131

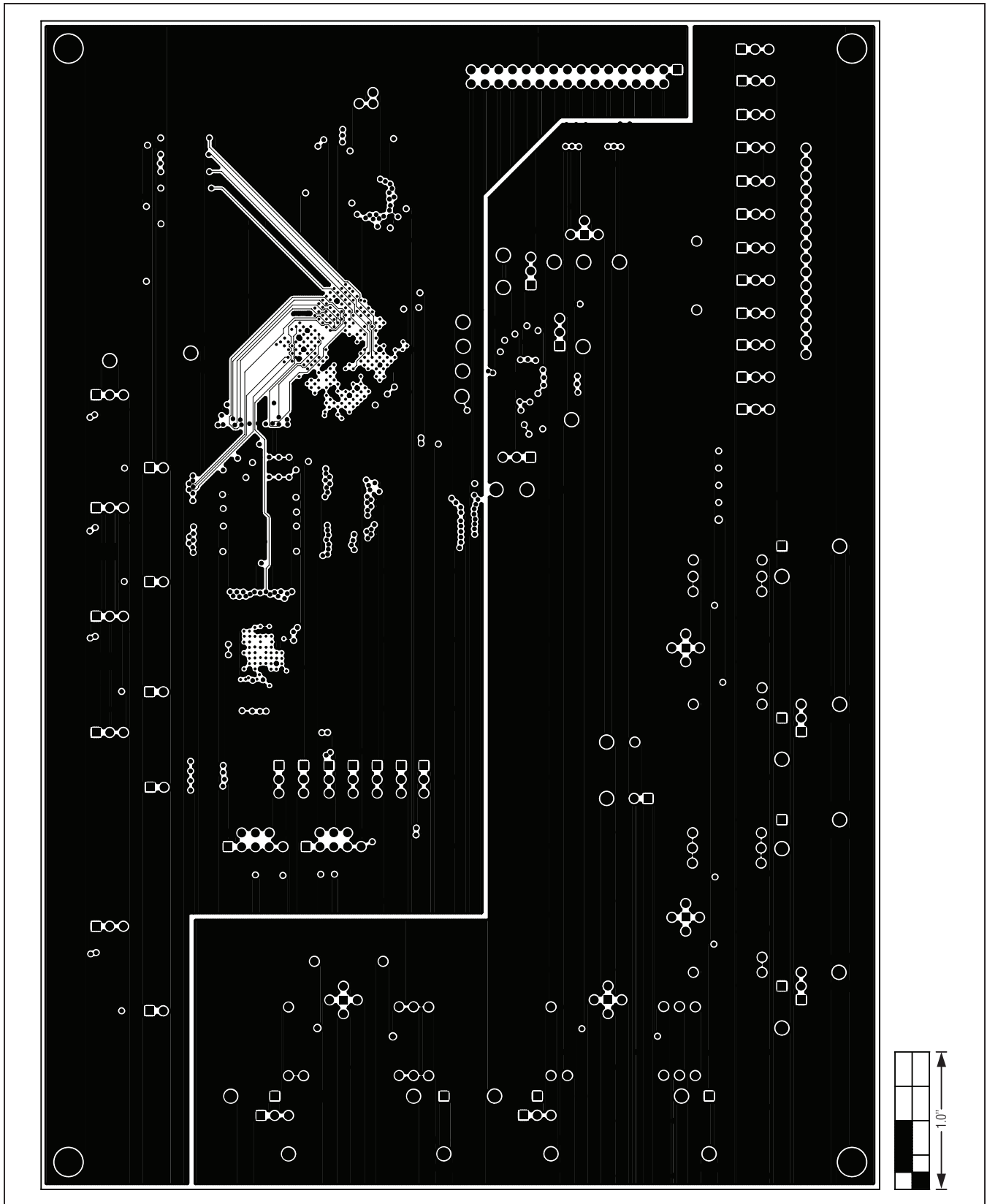

Figure 13. MAX11131 EV Kit PCB Layout—Layer 4

MAX11131 Evaluation Kit

Evaluates: MAX11131

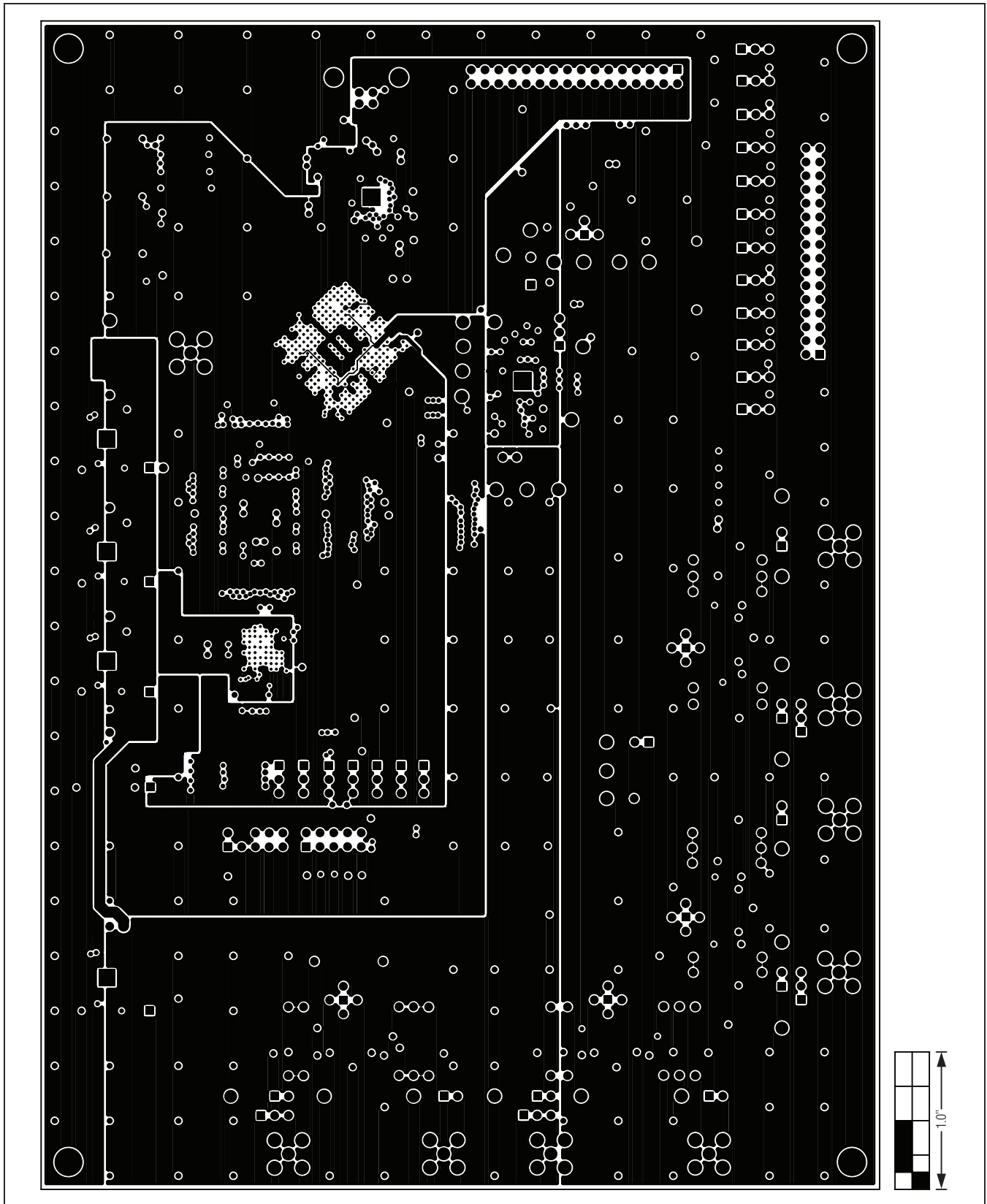

Figure 14. MAX11131 EV Kit PCB Layout—Layer 5

MAX11131 Evaluation Kit

Evaluates: MAX11131

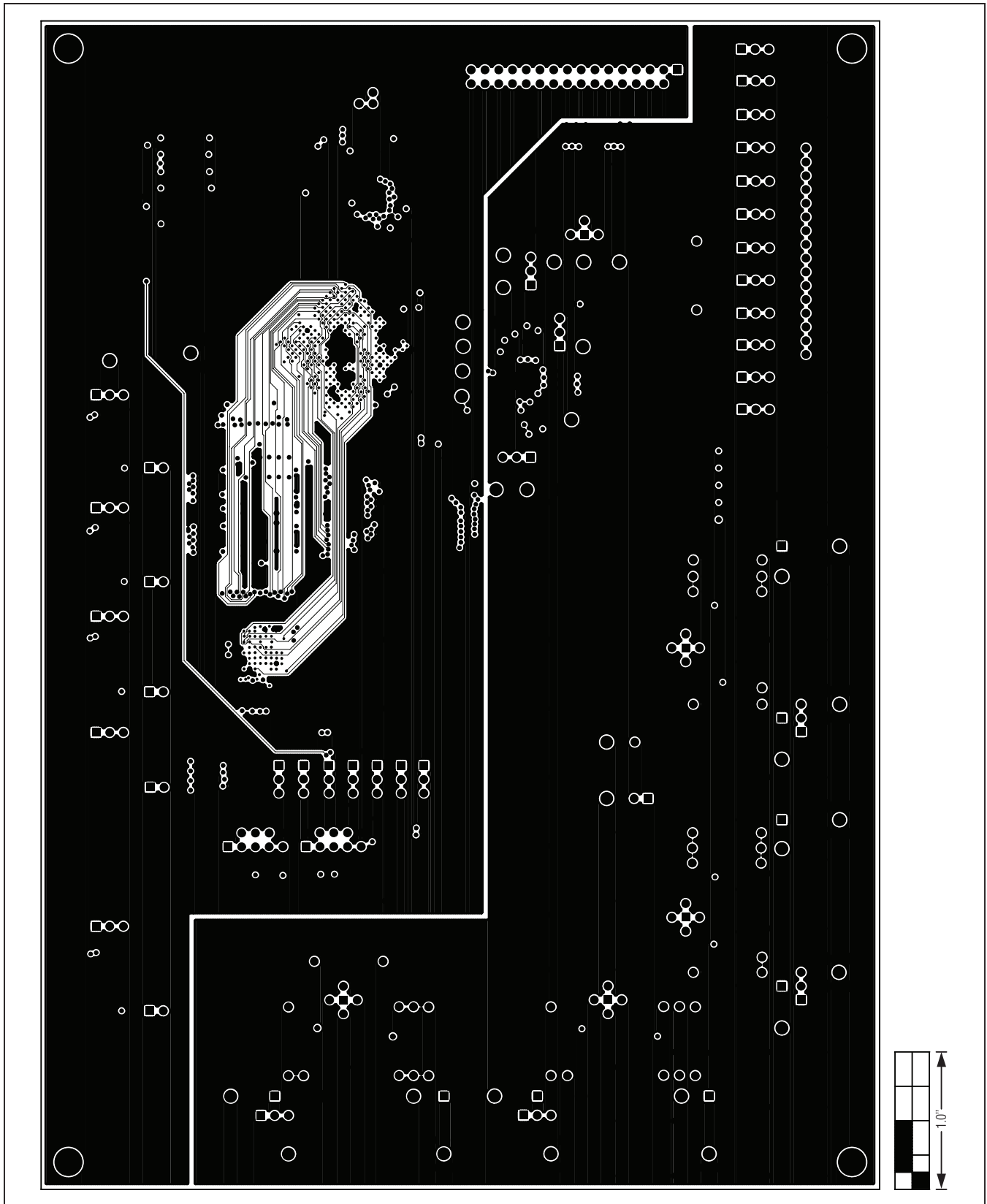

Figure 15. MAX11131 EV Kit PCB Layout—Layer 6

MAX11131 Evaluation Kit

Evaluates: MAX11131

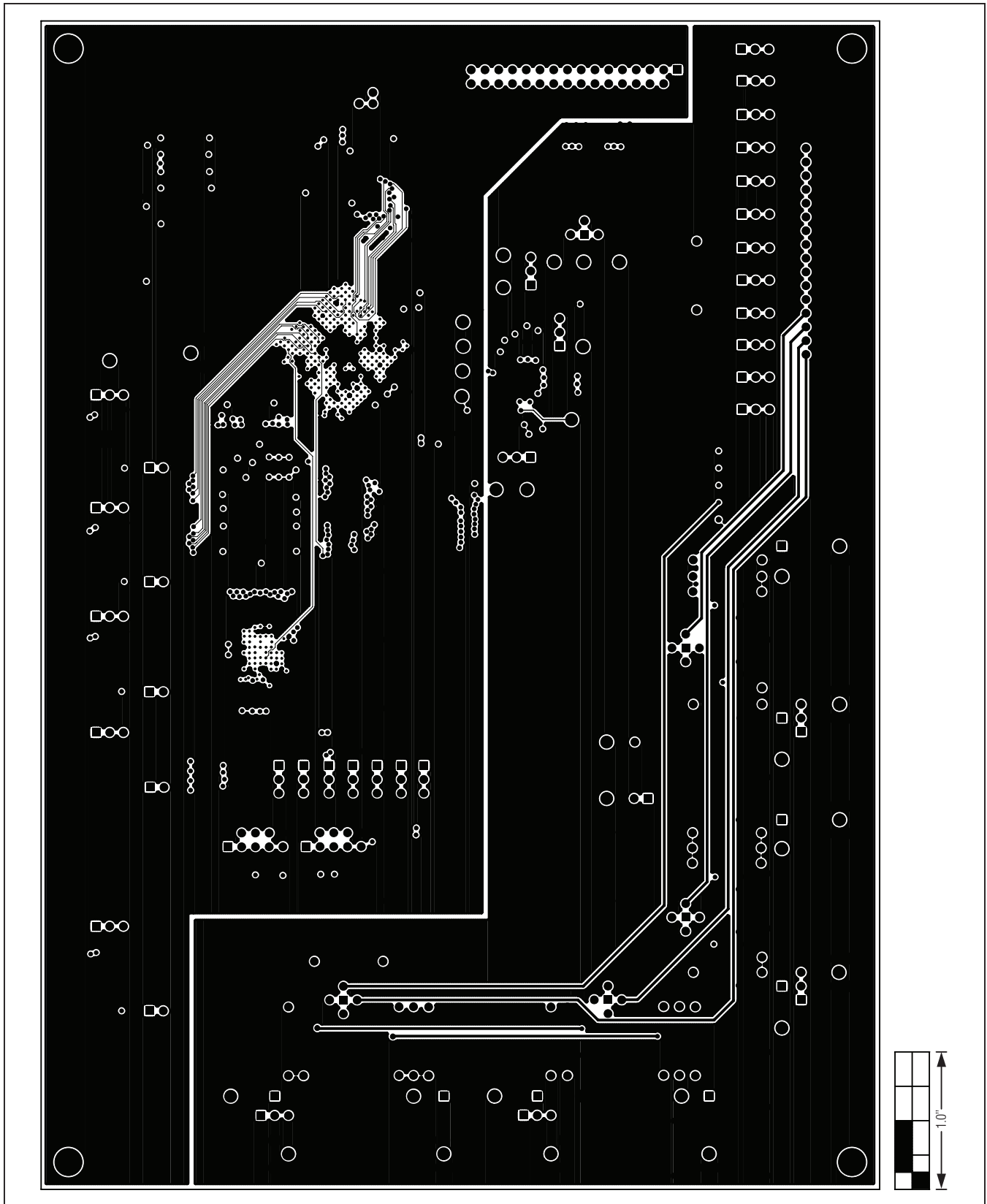

Figure 16. MAX11131 EV Kit PCB Layout—Layer 7

MAX11131 Evaluation Kit

Evaluates: MAX11131

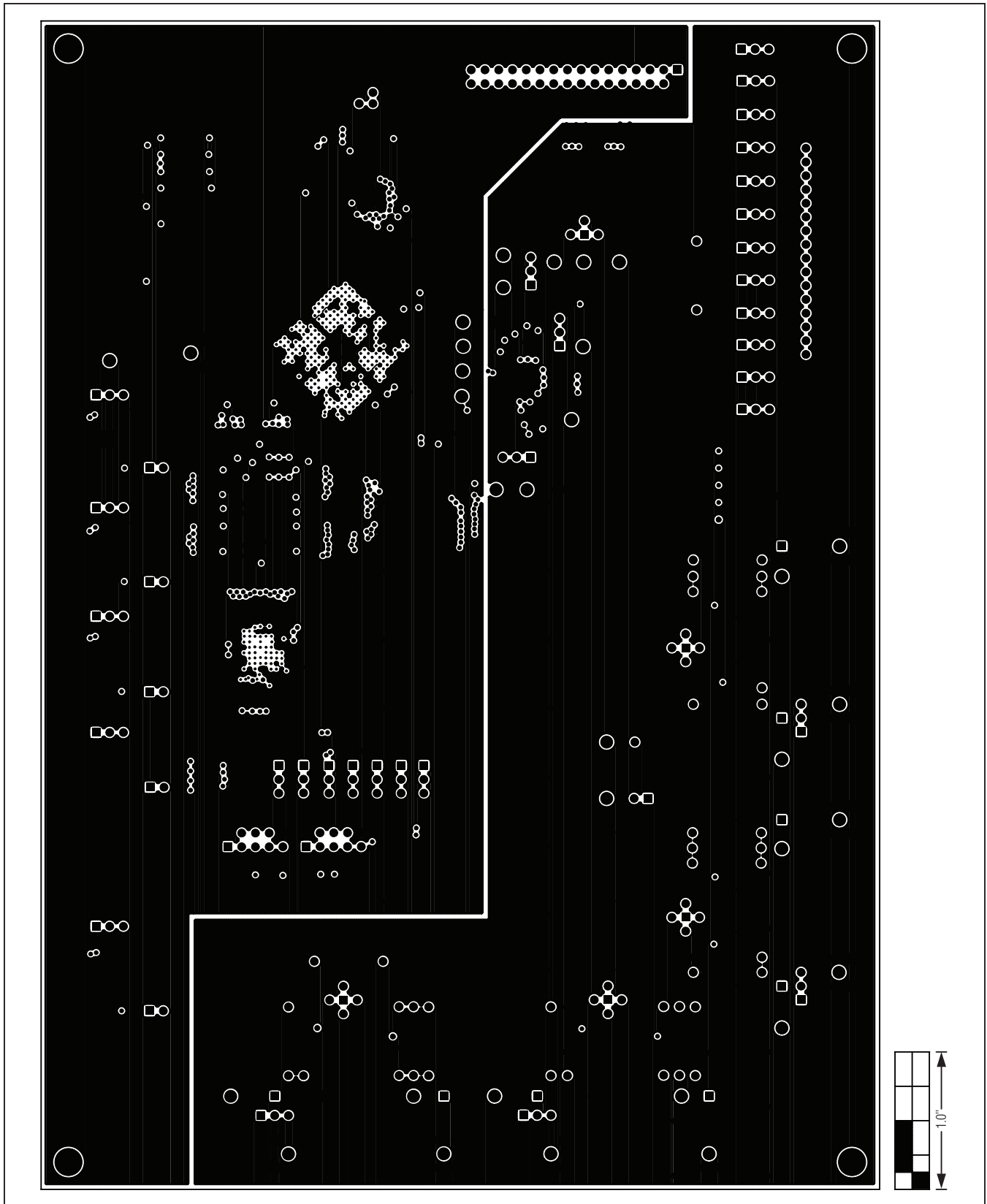

Figure 17. MAX11131 EV Kit PCB Layout—Layer 8

MAX11131 Evaluation Kit

Evaluates: MAX11131

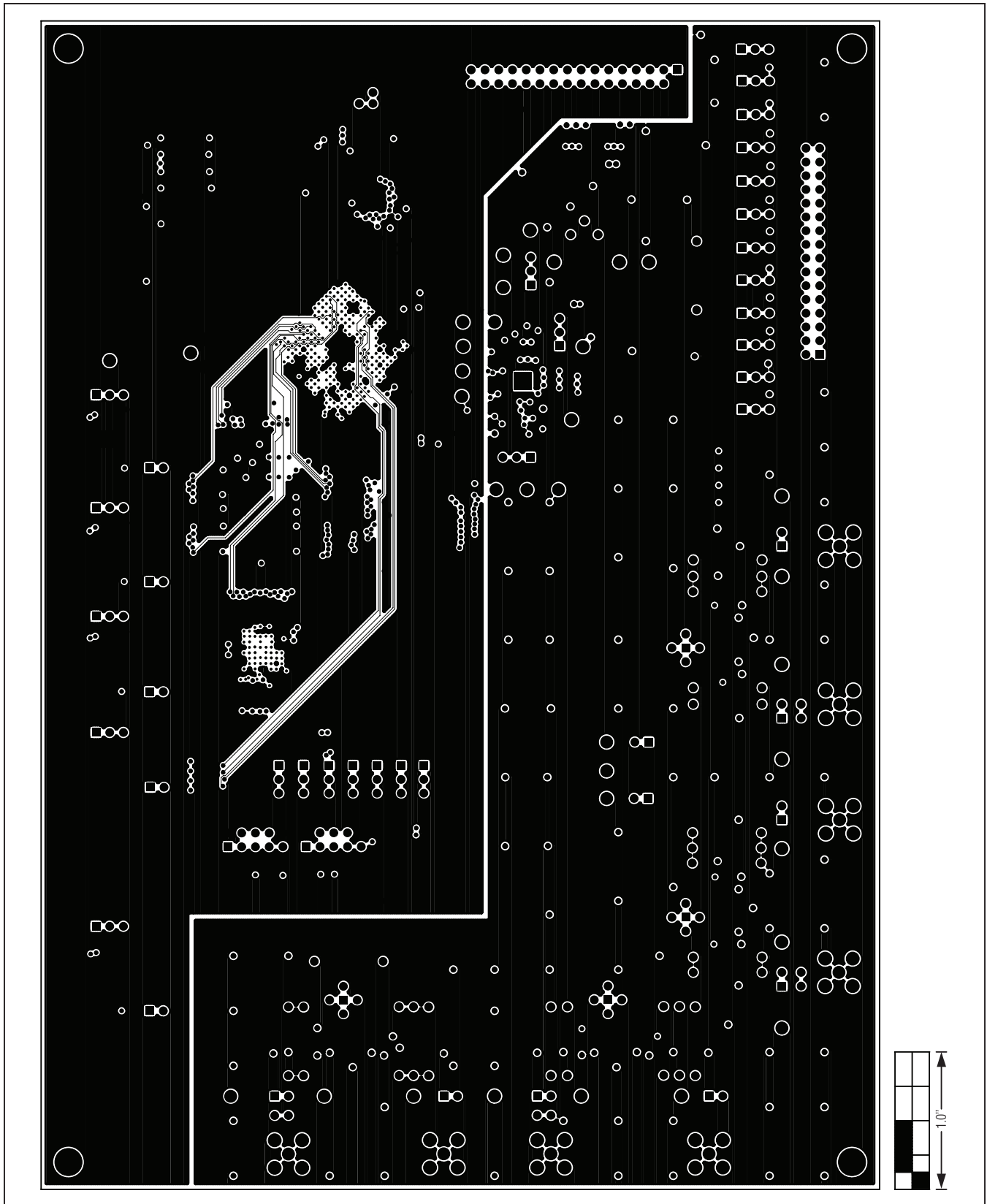

Figure 18. MAX11131 EV Kit PCB Layout—Layer 9

MAX11131 Evaluation Kit

Evaluates: MAX11131

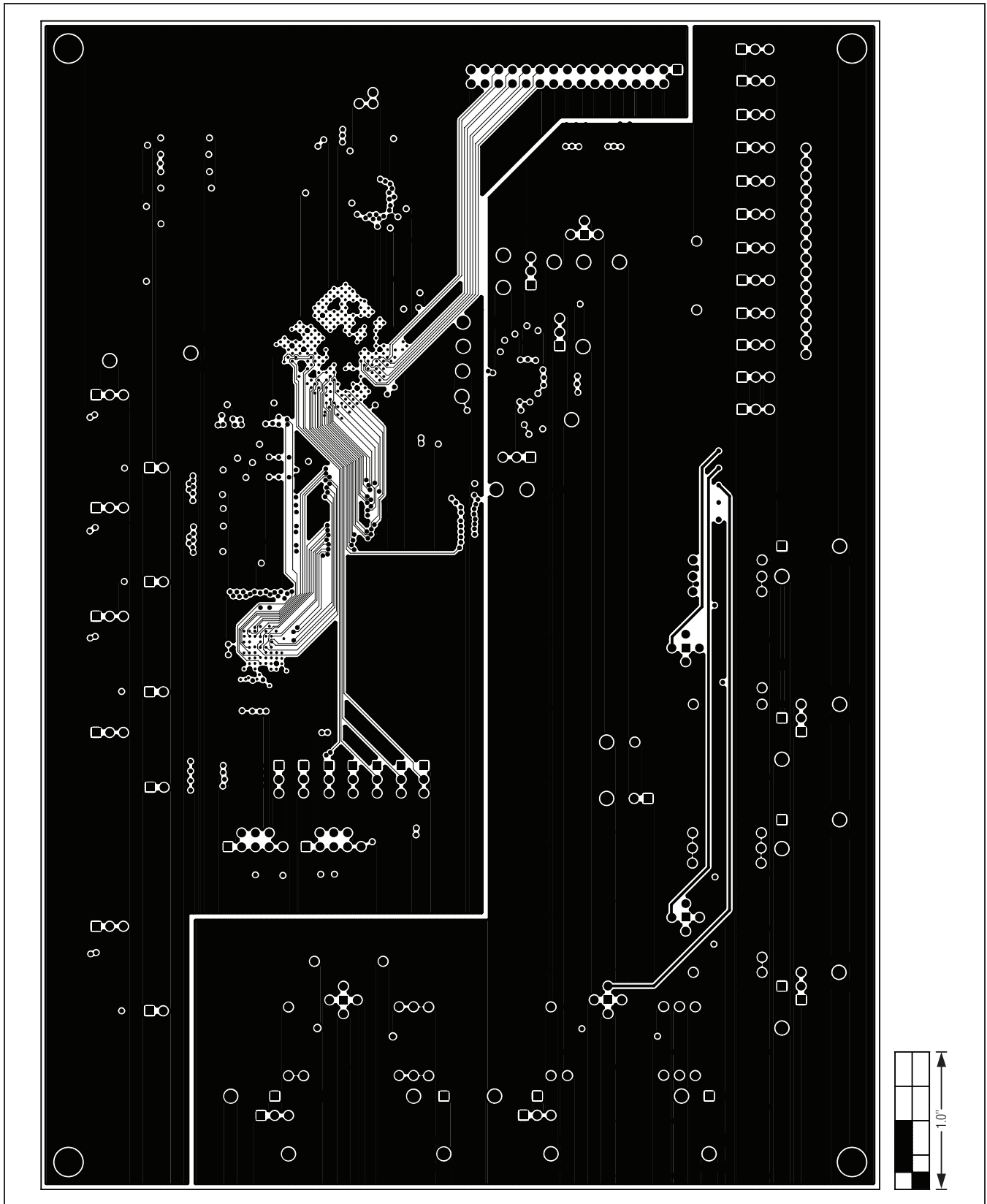

Figure 19. MAX11131 EV Kit PCB Layout—Layer 10

MAX11131 Evaluation Kit

Evaluates: MAX11131

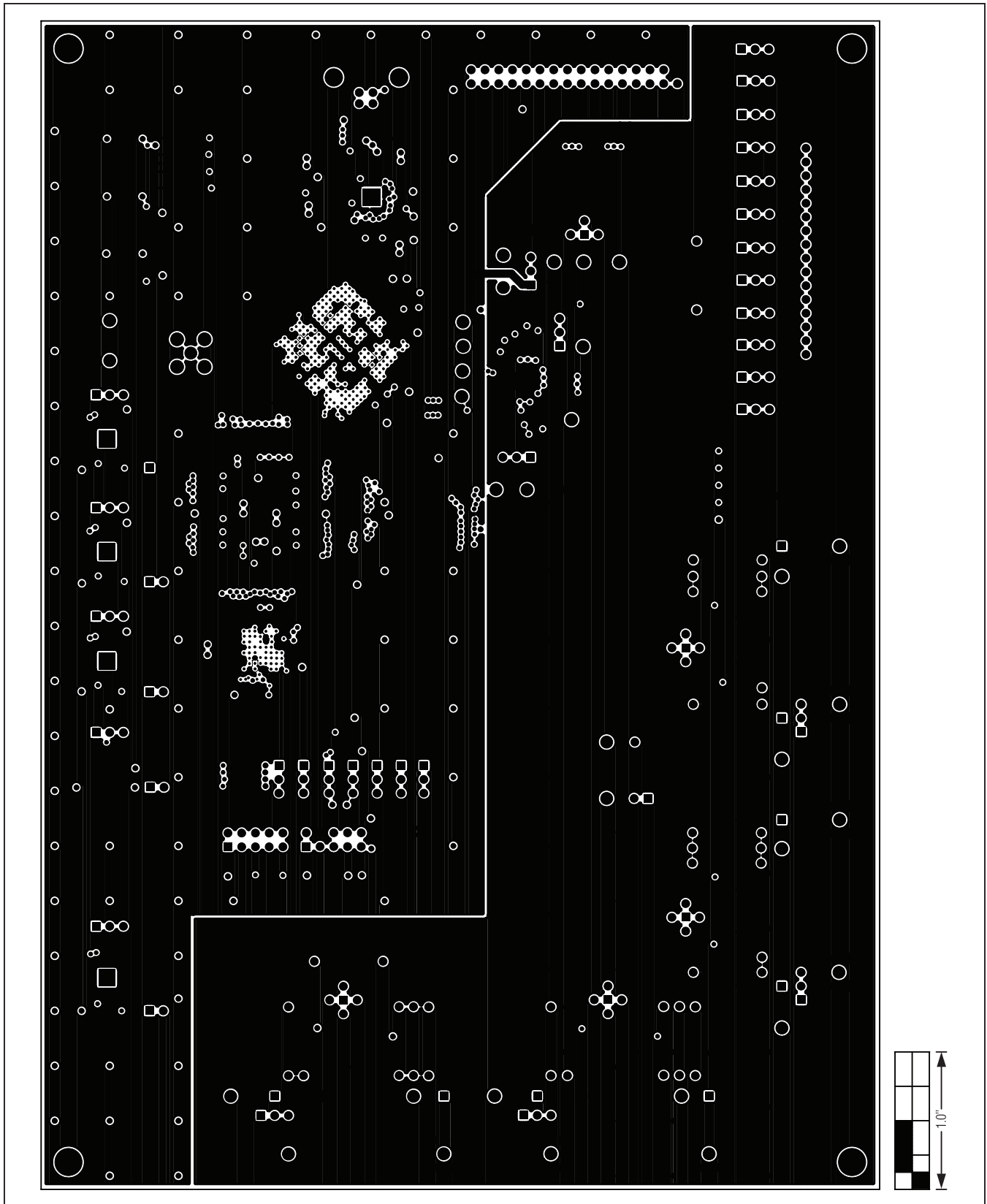

Figure 20. MAX11131 EV Kit PCB Layout—Layer 11

MAX11131 Evaluation Kit

Evaluates: MAX11131

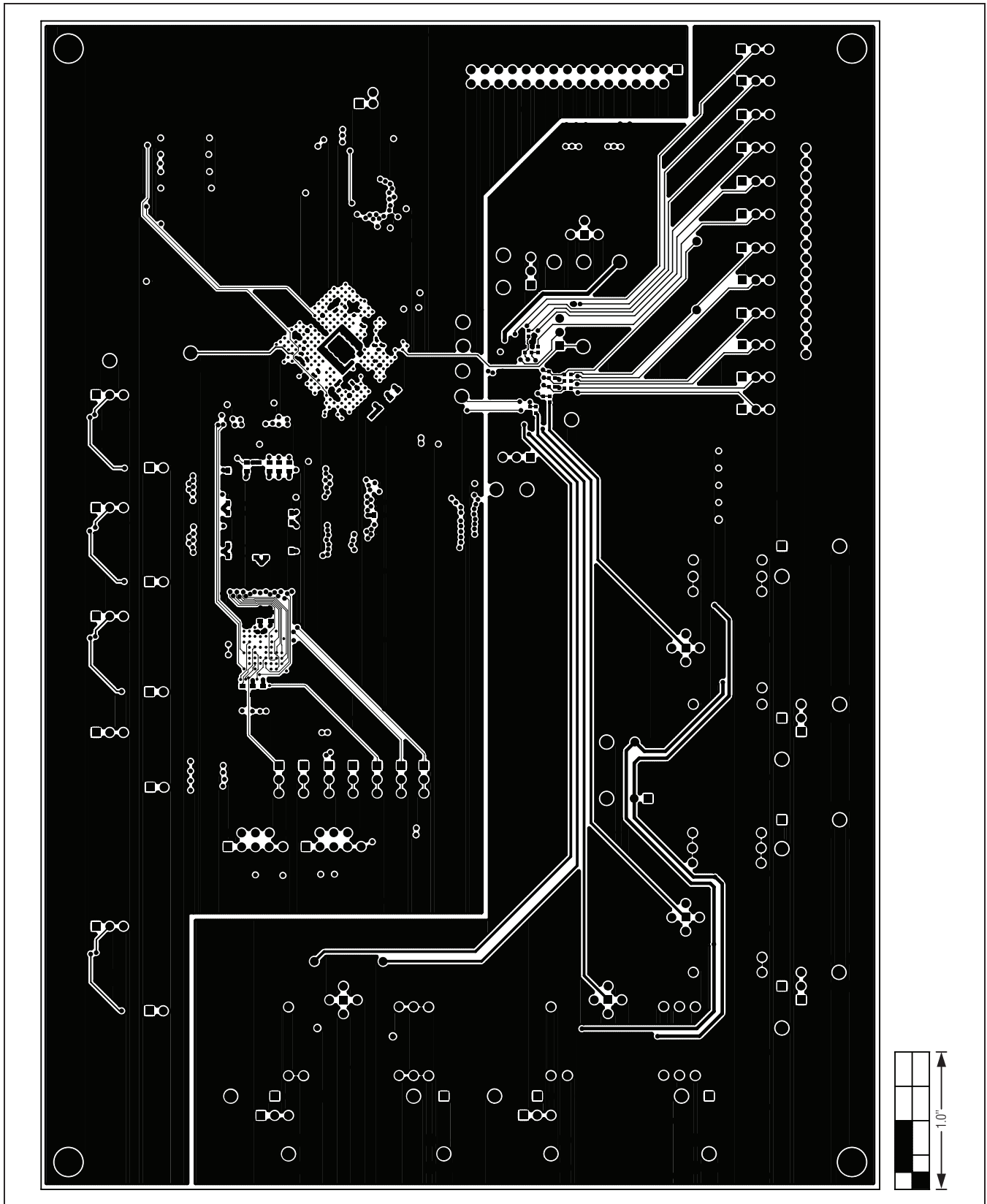

Figure 21. MAX11131 EV Kit PCB Layout—Bottom Side

MAX11131 Evaluation Kit

Evaluates: MAX11131

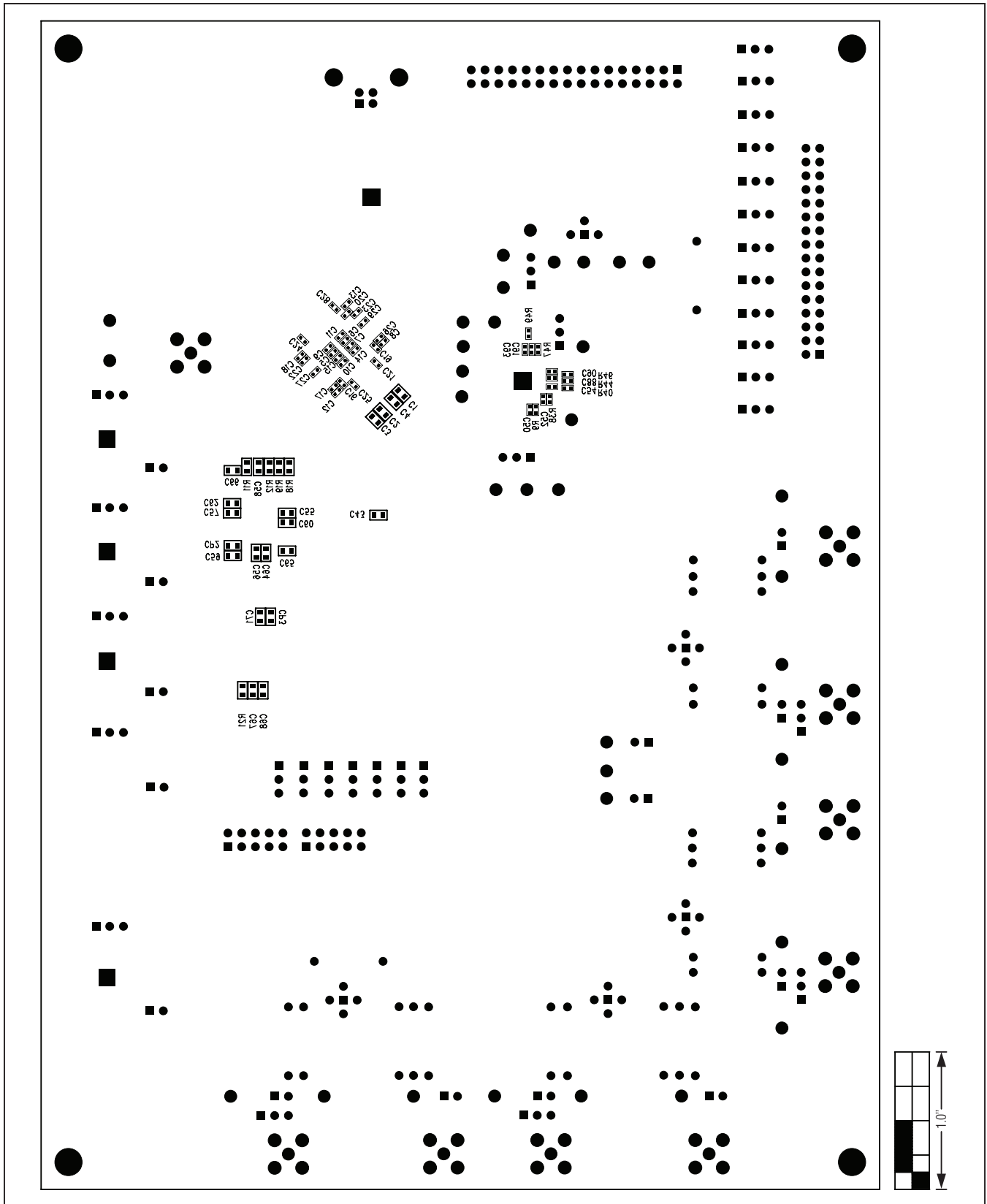

Figure 22. MAX11131 EV Kit Component Placement Guide—Bottom

MAX11131 Evaluation Kit

Evaluates: MAX11131

Ordering Information

PART	TYPE
MAX11131EVKIT#	EV Kit

#Denote RoHS compliant.

MAX11131 Evaluation Kit

Evaluates: MAX11131

Revision History

REVISION NUMBER	REVISION DATE	DESCRIPTION	PAGES CHANGED
0	4/12	Initial release	—

Maxim cannot assume responsibility for use of any circuitry other than circuitry entirely embodied in a Maxim product. No circuit patent licenses are implied. Maxim reserves the right to change the circuitry and specifications without notice at any time.

Maxim Integrated Products, 120 San Gabriel Drive, Sunnyvale, CA 94086 408-737-7600 _____ 47