



# Specification

## C8WT728

SSC		CUSTOMER
Drawn	Approval	Approval

# CONTENTS

1. Description
2. Absolute Maximum Ratings
3. Electro-Optical Characteristics
4. Optical characteristics
5. Reliability Test
6. Color & Binning
7. Bin Code Description
8. Outline Dimension
9. Reel Structure
10. Packing
11. Soldering
12. Precaution for use
13. Handling of Silicone Resin LEDs

# C8WT728

# C8WT728

## 1. Description

TOP VIEW LED is designed for high current operation and high flux output applications.



Furthermore, its thermal management characteristic is better than other LED solutions by package SMD design and good thermal emission material.

According to these advantages, it enables to apply various lighting applications and design solution, automotive lighting etc.

## Features

- White & Warm colored SMT package.
- High CRI PKG
- Pb-free Reflow Soldering Application
- Suitable for all SMT assembly methods ; Suitable for all soldering methods
- RoHS Compliant

## Applications

- Interior lighting
- General lighting
- Indoor and out door displays
- Architectural / Decorative lighting

## 2. Absolute maximum ratings [1]

Parameter	Symbol	Value	Unit
Power Dissipation	$P_d$	324	mW
Forward Current	$I_F$	90	mA
Peak Forward Current (per die)	$I_{FM}^{[2]}$	100	mA
Reverse Voltage (per die)	$V_R$	5	V
Operating Temperature	$T_{opr}$	-40~+85	°C
Storage Temperature	$T_{stg}$	-40~+100	°C
Junction Temperature	$T_j$	125	°C

[1] Care is to be taken that power dissipation does not exceed the absolute maximum rating of the product.

[2]  $I_{FM}$  was measured at  $T_w \leq 1$  msec of pulse width and  $D \leq 1/10$  of duty ratio.

## 3. Electro-Optical characteristics

Parameter	Symbol	Condition	Min.	Typ.	Max.	Unit
Forward Voltage (per die) *	$V_F$	$I_F=20\text{mA}$	2.9	3.2	3.5	V
Reverse Current (per die)	$I_R$	$V_F=5\text{V}$	-	-	10	$\mu\text{A}$
Luminous Intensity* <sup>[1]</sup> (4,700~7,000 K)	$I_v$	$I_F=60\text{mA}$	4.0	5.2	-	cd
Luminous Intensity* <sup>[1]</sup> (2,600~4,700 K)	$I_v$	$I_F=60\text{mA}$	4.0	5.0	-	cd
Luminance Flux*	$\Phi_V$	$I_F=60\text{mA}$	-	16.5	-	lm
Color Temperature	CCT	$I_F=60\text{mA}$	2,600	-	7,000	K
Optical Temperature	$\theta_{elc}$	$I_F=60\text{mA}$	-	83	-	lm/W
Viewing Angle <sup>[2]</sup>	$2\theta_{1/2}$	$I_F=60\text{mA}$	-	120	-	deg.
Color Rendering Index*	Ra	$I_F=60\text{mA}$	75	83	-	-
ESD (HBM)		1.5k $\Omega$ ; 100pF	1	-	-	KV
Thermal resistance <sup>[3]</sup>	$R_{thJS}$	$I_F=20\text{mA}$		18		°C/W

[1] The luminous intensity  $I_v$  was measured at the peak of the spatial pattern which may not be aligned with the mechanical axis of the LED package.

[2]  $2\theta_{1/2}$  is the off-axis where the luminous intensity is 1/2 of the peak intensity.

[3] Thermal resistance:  $R_{thJS}$  (Junction / solder)

\* Tolerance :  $V_F : \pm 0.05\text{V}$ ,  $I_v : \pm 10\%$ ,  $\Phi_V : \pm 10\%$ ,  $R_a : \pm 3$ ,  $x, y : \pm 0.01$

[Note] All measurements were made under the standardized environment of SSC.

Rev. 05

March 2010

[www.acriche.com](http://www.acriche.com)

SSC-QP-7-07-24 (Rev.00)

### 4. Optical characteristics

Forward Voltage vs. Forward Current (Per die)

Ta=25°C

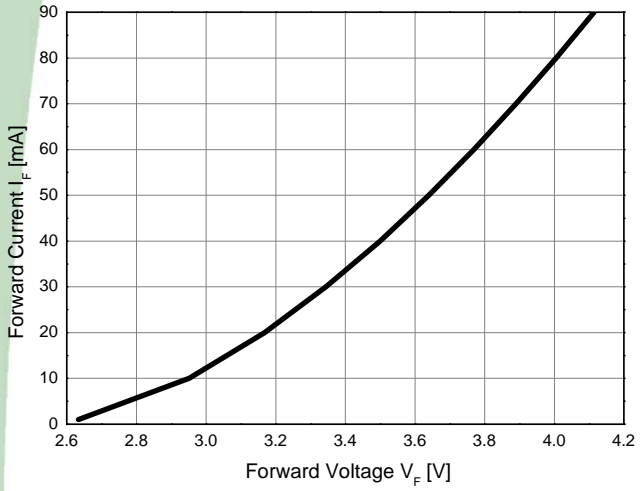

Forward Current vs. Relative Luminous Intensity

Ta=25°C

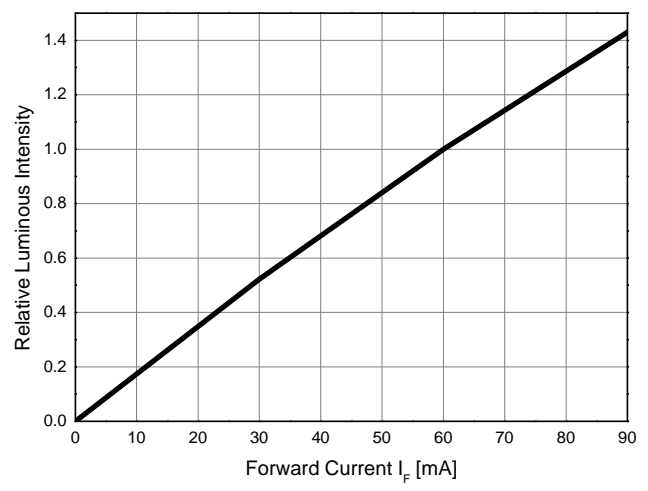

Ambient Temperature vs. Maximum Forward Current (per die)

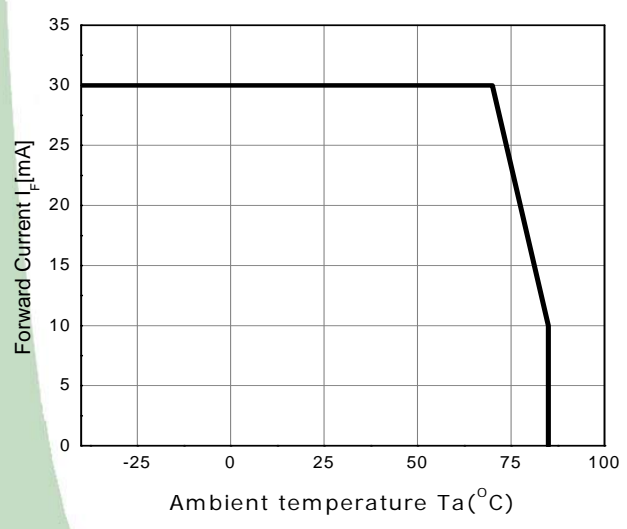

Directivity

Ta=25°C

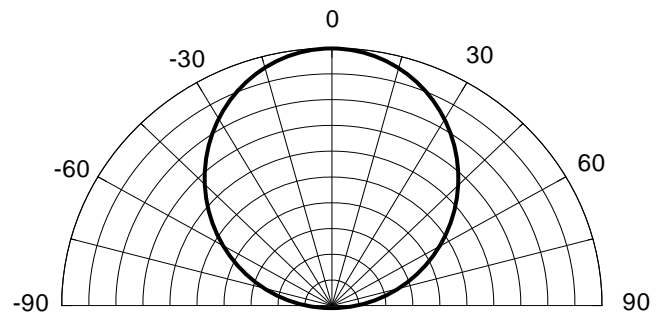

### 4. Optical characteristics

Spectrum

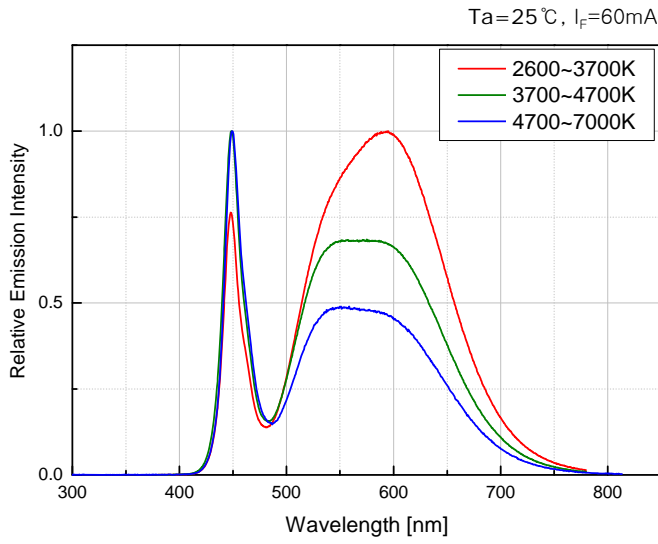

## 5. Reliability Test

Item	Reference	Test Conditions	Duration / Cycle	Number of Damaged
Thermal Shock	EIAJ ED-4701	$T_a = -40^{\circ}\text{C}(30\text{min}) \sim 100^{\circ}\text{C}(30\text{min})$	100 Cycle	0/22
High Temperature Storage	EIAJ ED-4701	$T_a = 100^{\circ}\text{C}$	1000 Hours	0/22
High Temp. High Humidity Storage	EIAJ ED-4701	$T_a = 60^{\circ}\text{C}, \text{RH}=90\%$	1000 Hours	0/22
Low Temperature Storage	EIAJ ED-4701	$T_a = -40^{\circ}\text{C}$	1000 Hours	0/22
Operating Endurance Test	Internal Reference	$T_a = 25^{\circ}\text{C}, I_F = 60\text{mA}$	1000 Hours	0/22
High Temperature High Humidity Life Test	Internal Reference	$T_a = 60^{\circ}\text{C}, \text{RH}=90\%, I_F = 60\text{mA}$	500 Hours	0/22
High Temperature Life Test	Internal Reference	$T_a = 85^{\circ}\text{C}, I_F = 60\text{mA}$	500 Hours	0/22
Low Temperature Life Test	Internal Reference	$T_a = -40^{\circ}\text{C}, I_F = 60\text{mA}$	1000 Hours	0/22
ESD(HBM)	MIL-STD-883D	1KV at 1.5k $\Omega$ ; 100pF	3 Time	0/22

### □ CRITERIA FOR JUDGING THE DAMAGE

Item	Symbol	Condition	Criteria for Judgment	
			MIN	MAX
Forward Voltage	$V_F$	$I_F = 60\text{mA}$ (20mA per die)	-	USL <sup>[1]</sup> × 1.2
Luminous Intensity	$I_V$	$I_F = 60\text{mA}$ (20mA per die)	LSL <sup>[2]</sup> × 0.5	-

Note : [1] USL : Upper Standard Level  
 [2] LSL : Lower Standard Level

### 6. Color & Binning

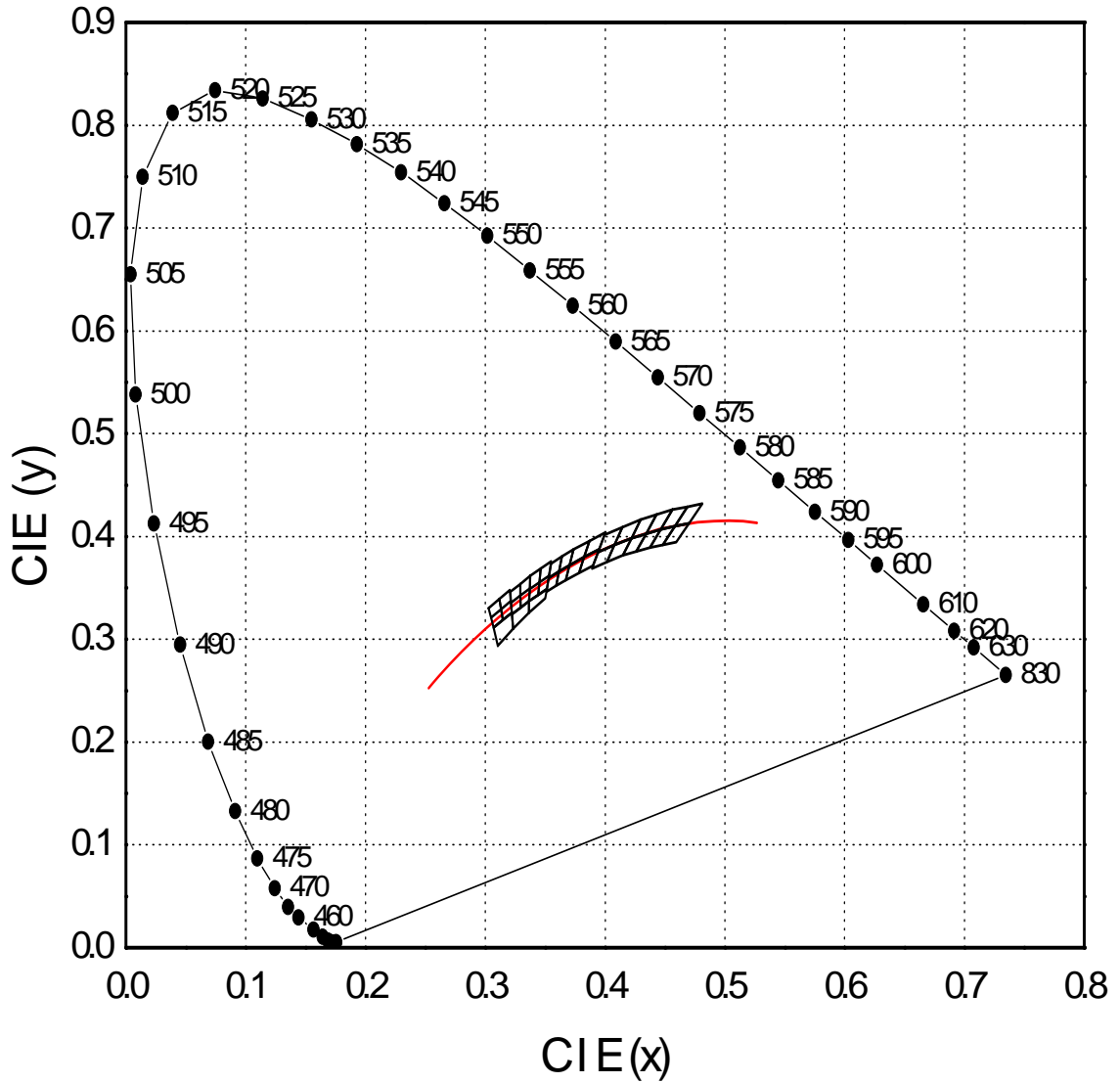



### 6. Color & Binning

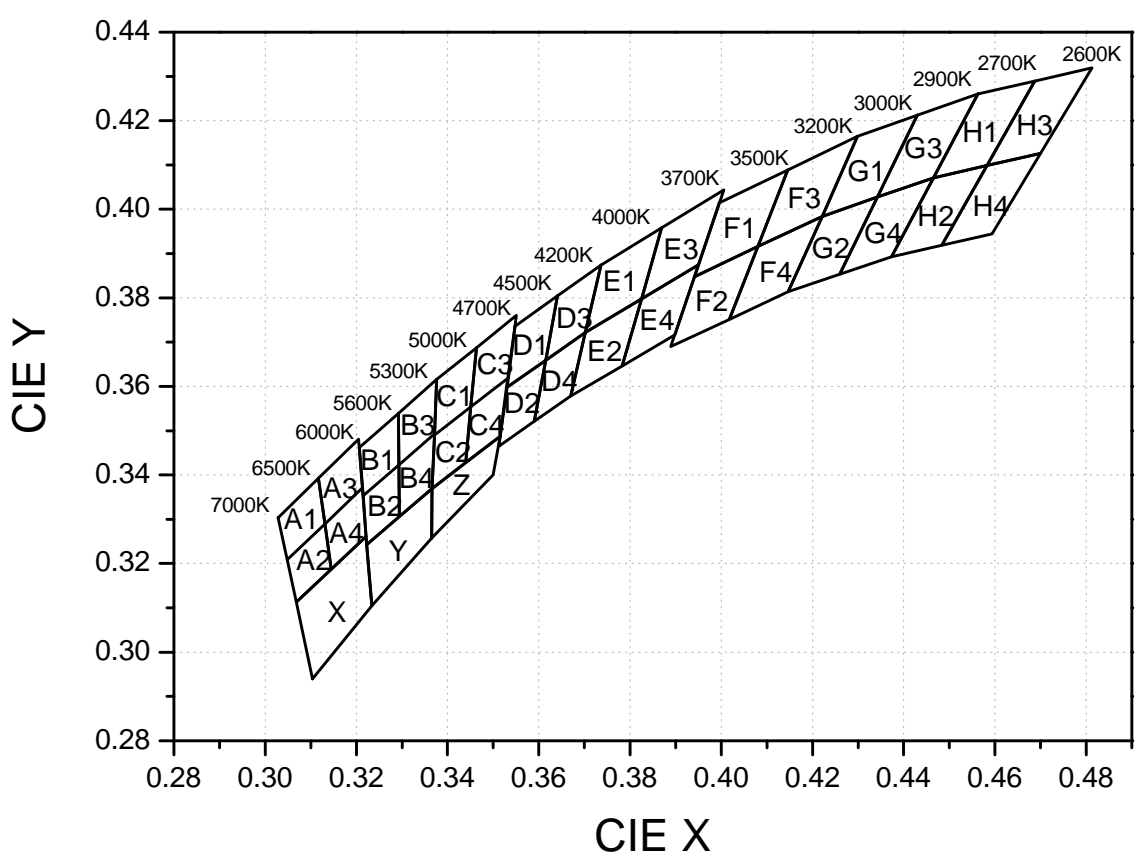

## 6. Color & Binning

● COLOR RANK

<IF=60mA, Ta=25℃>

7000 ~ 6500 K				6500 ~ 6000 K			
A1		A2		A3		A4	
CIE X	CIE Y	CIE X	CIE Y	CIE X	CIE Y	CIE X	CIE Y
0.3028	0.3304	0.3048	0.3209	0.3117	0.3393	0.3131	0.3290
0.3048	0.3209	0.3068	0.3113	0.3131	0.3290	0.3145	0.3187
0.3131	0.3290	0.3145	0.3187	0.3213	0.3371	0.3221	0.3261
0.3117	0.3393	0.3131	0.3290	0.3205	0.3481	0.3213	0.3371
6000 ~ 5600 K				5600 ~ 5300 K			
B1		B2		B3		B4	
CIE X	CIE Y	CIE X	CIE Y	CIE X	CIE Y	CIE X	CIE Y
0.3207	0.3462	0.3215	0.3353	0.3292	0.3539	0.3293	0.3423
0.3215	0.3353	0.3222	0.3243	0.3293	0.3423	0.3294	0.3306
0.3293	0.3423	0.3294	0.3306	0.3371	0.3493	0.3366	0.3369
0.3292	0.3539	0.3293	0.3423	0.3376	0.3616	0.3371	0.3493
5300 ~ 5000 K				5000 ~ 4700 K			
C1		C2		C3		C4	
CIE X	CIE Y	CIE X	CIE Y	CIE X	CIE Y	CIE X	CIE Y
0.3376	0.3616	0.3371	0.349	0.3463	0.3687	0.3451	0.3554
0.3371	0.349	0.3366	0.3369	0.3451	0.3554	0.344	0.3428
0.3451	0.3554	0.344	0.3428	0.3533	0.362	0.3515	0.3487
0.3463	0.3687	0.3451	0.3554	0.3551	0.376	0.3533	0.362
7000 ~ 6000 K		6000 ~ 5300 K		5300 ~ 4700 K			
X		Y		Z			
CIE X	CIE Y	CIE X	CIE Y	CIE X	CIE Y		
0.3104	0.294	0.3234	0.3105	0.3365	0.3258		
0.3068	0.3113	0.3222	0.3243	0.3366	0.3369		
0.3221	0.3261	0.3366	0.3369	0.3515	0.3487		
0.3234	0.3105	0.3365	0.3258	0.35	0.34		

● A~C, X~Z -> CCT 4700 ~ 7000 K

## 6. Color & Binning

● COLOR RANK

<IF=60mA, Ta=25℃>

4700 ~ 4500 K				4500 ~ 4200 K			
D1		D2		D3		D4	
CIE X	CIE Y	CIE X	CIE Y	CIE X	CIE Y	CIE X	CIE Y
0.3548	0.3736	0.3529	0.3597	0.3641	0.3804	0.3615	0.3659
0.3529	0.3597	0.3512	0.3465	0.3615	0.3659	0.359	0.3521
0.3615	0.3659	0.359	0.3521	0.3702	0.3722	0.367	0.3578
0.3641	0.3804	0.3615	0.3659	0.3736	0.3874	0.3702	0.3722
4200 ~ 4000 K				4000 ~ 3700 k			
E1		E2		E3		E4	
CIE X	CIE Y	CIE X	CIE Y	CIE X	CIE Y	CIE X	CIE Y
0.3736	0.3874	0.3702	0.3722	0.3869	0.3958	0.3825	0.3798
0.3702	0.3722	0.367	0.3578	0.3825	0.3798	0.3783	0.3646
0.3825	0.3798	0.3783	0.3646	0.395	0.3875	0.3898	0.3716
0.3869	0.3958	0.3825	0.3798	0.4006	0.4044	0.395	0.3875
3700 ~ 3500 K				3500 ~ 3200 K			
F1		F2		F3		F4	
CIE X	CIE Y	CIE X	CIE Y	CIE X	CIE Y	CIE X	CIE Y
0.3996	0.4015	0.3941	0.3848	0.4146	0.4089	0.408	0.3916
0.3941	0.3848	0.3889	0.369	0.408	0.3916	0.4017	0.3751
0.408	0.3916	0.4017	0.3751	0.4221	0.3984	0.4147	0.3814
0.4146	0.4089	0.408	0.3916	0.4299	0.4165	0.4221	0.3984
3200 ~ 3000 K				3000 ~ 2900 k			
G1		G2		G3		G4	
CIE X	CIE Y	CIE X	CIE Y	CIE X	CIE Y	CIE X	CIE Y
0.4299	0.4165	0.4221	0.3984	0.443	0.4212	0.4342	0.4028
0.4221	0.3984	0.4147	0.3814	0.4342	0.4028	0.4259	0.3853
0.4342	0.4028	0.4259	0.3853	0.4465	0.4071	0.4373	0.3893
0.443	0.4212	0.4342	0.4028	0.4562	0.426	0.4465	0.4071
2900 ~ 2700 K				2700 ~ 2600 K			
H1		H2		H3		H4	
CIE X	CIE Y	CIE X	CIE Y	CIE X	CIE Y	CIE X	CIE Y
0.4562	0.426	0.4465	0.4071	0.4687	0.4289	0.4582	0.4099
0.4465	0.4071	0.4373	0.3893	0.4582	0.4099	0.4483	0.3919
0.4582	0.4099	0.4483	0.3919	0.47	0.4126	0.4593	0.3944
0.4687	0.4289	0.4582	0.4099	0.4813	0.4319	0.47	0.4126

● D~H -> CCT 2600 ~ 4700 K

Rev. 05

March 2010

\* Measurement Uncertainty of the Color Coordinates : ± 0.01

www.acriche.com

SSC-QP-7-07-24 (Rev.00)

## 7. Bin Code Description

Bin Code		
Luminous Intensity [mcd]	Color Rank	Forward Voltage [V]
M0	A1	Z1



2,600K ~ 7,000K

Luminous Intensity [mcd] @ $I_F = 60\text{mA}$		
RANK	Min.	Max.
M0	4,000	4,500
M5	4,500	5,000
N0	5,000	5,500
N5	5,500	6,000
P0	6,000	6,500

Color Rank @ $I_F = 60\text{mA}$	
A1	A2
A3	A4
B1	B2
B3	B4
C1	C2
C3	C4
D1	D2
D3	D4
E1	E2
E3	E4
F1	F2
F3	F4
G1	G2
G3	G4
H1	H2
H3	H4
X	
Y	
Z	

Average for Total Forward Voltage [V] @ $I_F = 60\text{mA}$		
RANK	Min.	Max.
Y	2.9	3.0
Z1	3.0	3.1
Z2	3.1	3.2
Z3	3.2	3.3
A1	3.3	3.4
A2	3.4	3.5

### 8.Outline Dimension

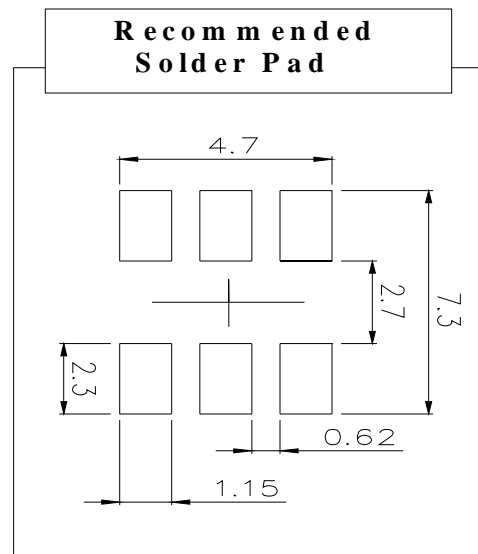
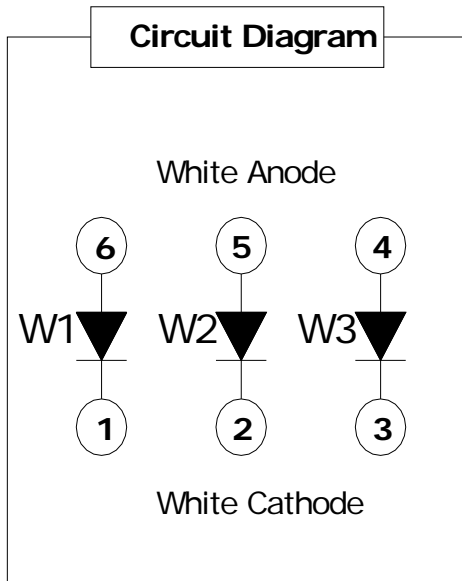
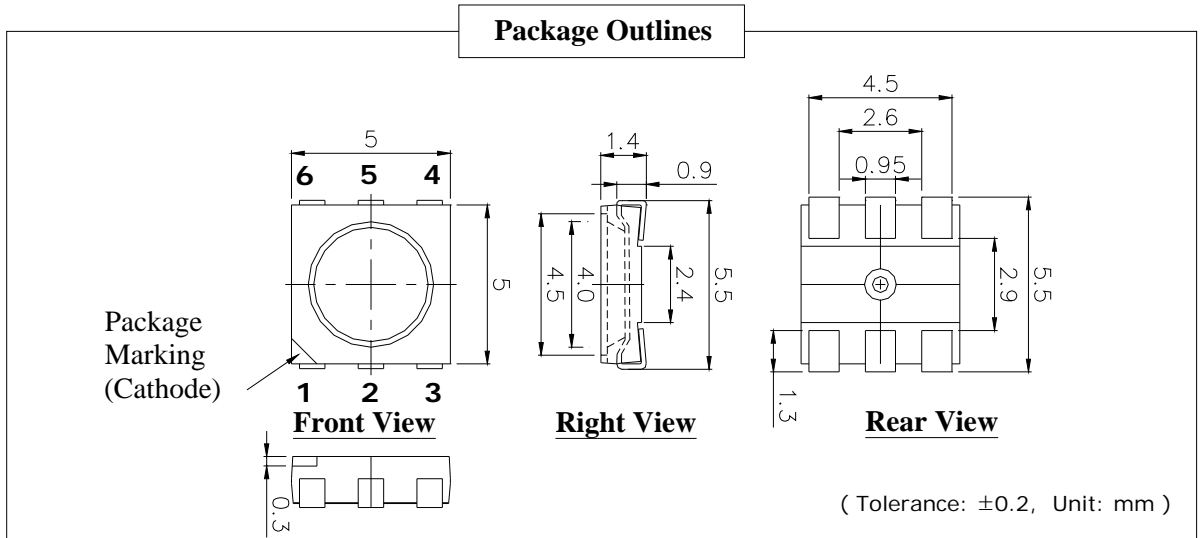

**\* MATERIALS**

PARTS	MATERIALS
Package	Heat-Resistant Polymer
Encapsulating Resin	Silicone Resin
Electrodes	Ag Plating Copper Alloy

### 9. Reel Structure

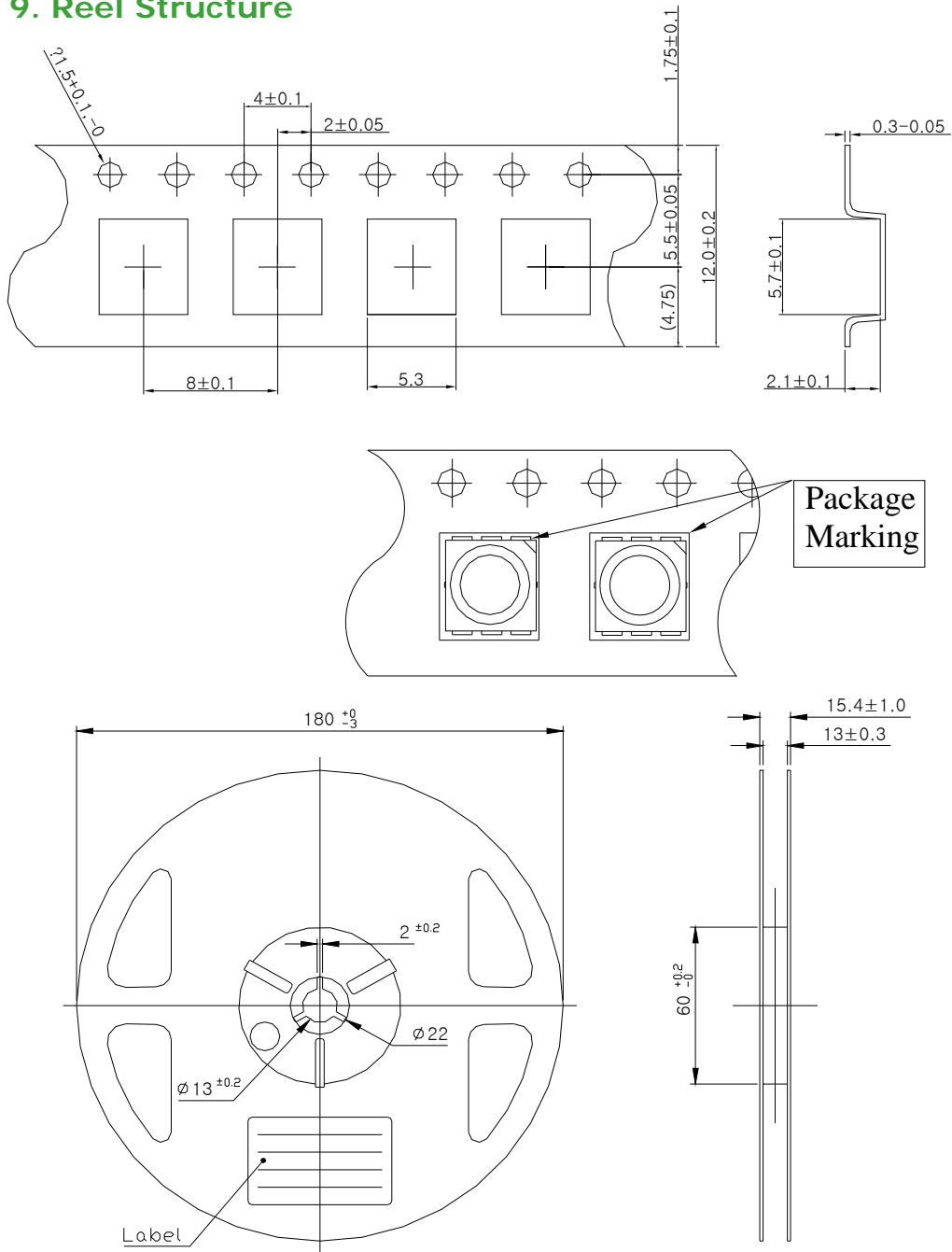

( Tolerance:  $\pm 0.2$ , Unit: mm )

- 1)Quantity : 1,000pcs/Reel
- 2)Cumulative Tolerance : Cumulative Tolerance/10 pitches to be  $\pm 0.2$ mm
- 3)Adhesion Strength of Cover Tape : Adhesion strength to be 0.1-0.7N when the cover tape is turned off from the carrier tape at the angle of 10 to the carrier tape
- 4)Package : P/N, Manufacturing data Code No. and quantity to be indicated on a damp proof Package

## 10. Packing

### Reel

RANK: XXXX  
 QUANTITY: XXXX  
 LOT NUMBER: XXXXXXXXXXXX  
 PART NUMBER: XXXXXXXX  
 SEOUL SEMICONDUCTOR CO., LTD.

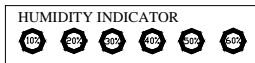
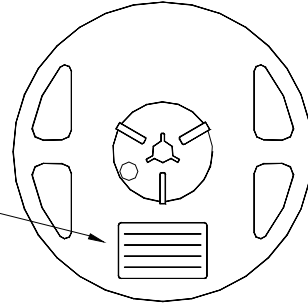

### Aluminum Vinyl Bag

RANK: XXXX  
 QUANTITY: XXXX  
 LOT NUMBER: XXXXXXXXXXXX  
 PART NUMBER: XXXXXXXX  
 SEOUL SEMICONDUCTOR CO., LTD.

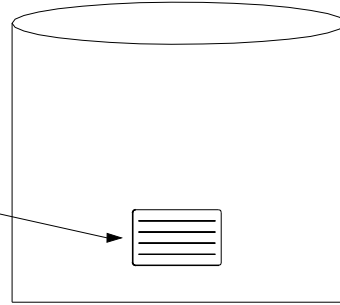

### Outer Box Structure

Material : Paper(SW3B(B))

TYPE	SIZE (mm)		
	Ⓐ	Ⓑ	Ⓒ
7inch	245	220	102
	245	220	142

#### Ⓐ SIDE

RANK: XXXX  
 QUANTITY: XXXX  
 LOT NUMBER: XXXXXXXXXXXX  
 PART NUMBER: XXXXXXXX  
 SEOUL SEMICONDUCTOR CO., LTD.

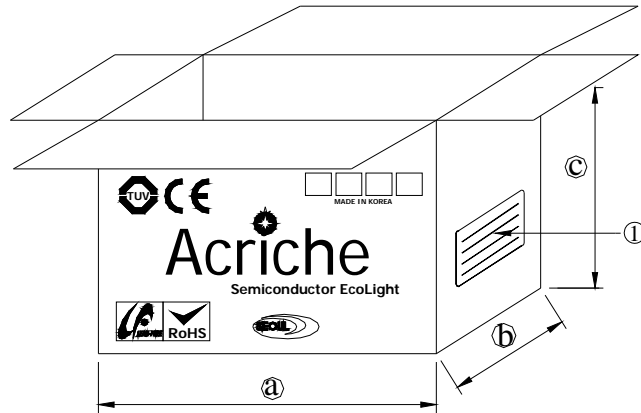

## 11. Soldering

### (1) Lead Solder

Lead Solder	
Pre-heat	120~150°C
Pre-heat time	120 sec. Max.
Peak-Temperature	240°C Max.
Soldering time Condition	10 sec. Max.

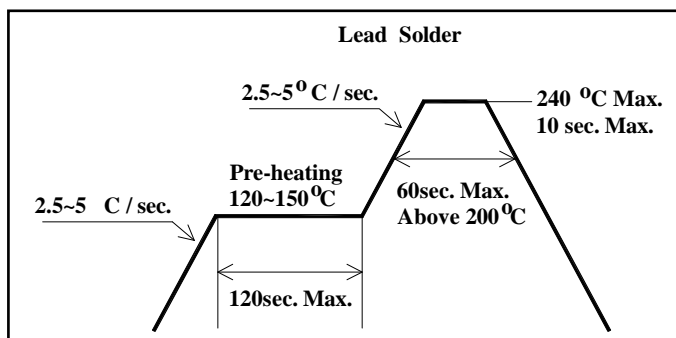

### (2) Lead-Free Solder

Lead Free Solder	
Pre-heat	150~200°C
Pre-heat time	120 sec. Max.
Peak-Temperature	260°C Max.
Soldering time Condition	10 sec. Max.

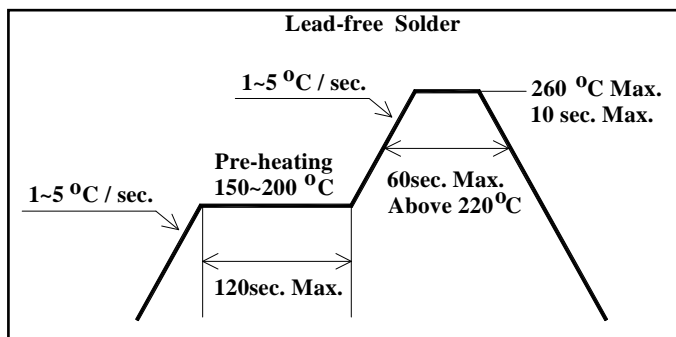

### (3) Hand Soldering conditions

Do not exceed 4 seconds at maximum 315°C under soldering iron.

### (4) The encapsulated material of the LEDs is silicone.

Precautions should be taken to avoid the strong pressure on the encapsulated part. So when using the chip mounter, the picking up nozzle that does not affect the silicone resin should be used.

[Note] In case that the soldered products are reused in soldering process, we don't guarantee the products.



## 12. Precaution for use

### 1) Storage

In order to avoid the absorption of moisture, it is recommended to store in a dry box (or a desiccator) with a desiccant. Otherwise, to store them in the following environment is recommended.

Temperature : 5°C ~30°C Humidity : maximum 65%RH

### 2) Attention after open.

LED is correspond to SMD, when LED be soldered dip, interfacial separation may affect the light transmission efficiency, causing the light intensity to drop. Attention in followed;

a. After opened and mounted the soldering shall be quickly.

b. Keeping of a fraction

Temperature : 5 ~ 40°C Humidity : less than 30%

3) In the case of more than 4 week passed after opening or change color of indicator on desiccant, components shall be dried 10-12hr. at 60±5°C.

4) Any mechanical force or any excess vibration shall not be accepted to apply during cooling process to normal temperature after soldering.

5) Quick cooling shall be avoided.

6) Components shall not be mounted on warped direction of PCB.

7) Anti radioactive ray design is not considered for the products.

8) This device should not be used in any type of fluid such as water, oil, organic solvent etc. When washing is required, IPA should be used.

9) When the LEDs are illuminating, operating current should be decided after considering the ambient maximum temperature.

10) LEDs must be stored to maintain a clean atmosphere. If the LEDs are stored for 3 months or more after being shipped from SSC, a sealed container with a nitrogen atmosphere should be used for storage.

11) The LEDs must be soldered within seven days after opening the moisture-proof packing.

12) Repack unused products with anti-moisture packing, fold to close any opening and then store in a dry place.

13) The appearance and specifications of the product may be modified for improvement without notice.

### 13. Handling of Silicone Resin LEDs

1) During processing, mechanical stress on the surface should be minimized as much as possible. Sharp objects of all types should not be used to pierce the sealing compound.



2) In general, LEDs should only be handled from the side. By the way, this also applies to LEDs without a silicone sealant, since the surface can also become scratched.

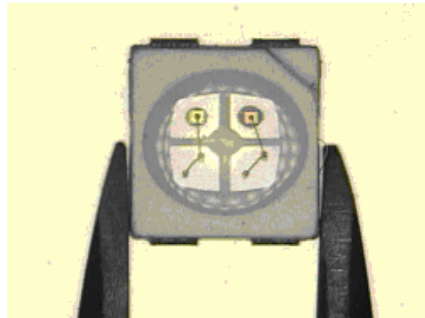

3) When populating boards in SMT production, there are basically no restrictions regarding the form of the pick and place nozzle, except that mechanical pressure on the surface of the resin must be prevented. This is assured by choosing a pick and place nozzle which is larger than the LED's reflector area.

4) Silicone differs from materials conventionally used for the manufacturing of LEDs. These conditions must be considered during the handling of such devices. Compared to standard encapsulants, silicone is generally softer, and the surface is more likely to attract dust.

As mentioned previously, the increased sensitivity to dust requires special care during processing. In cases where a minimal level of dirt and dust particles cannot be guaranteed, a suitable cleaning solution must be applied to the surface after the soldering of components.

5) SSC suggests using isopropyl alcohol for cleaning. In case other solvents are used, it must be assured that these solvents do not dissolve the package or resin. Ultrasonic cleaning is not recommended. Ultrasonic cleaning may cause damage to the LED.

6) Please do not mold this product into another resin (epoxy, urethane, etc) and do not handle this product with acid or sulfur material in sealed space.