

## SILICON RFIC 2.5 GHz FREQUENCY UP-CONVERTER FOR WIRELESS TRANSCEIVER

### FEATURES

- **RECOMMENDED OPERATING FREQUENCY:**  
f<sub>RFout</sub> = 0.8 to 2.5 GHz
- **SUPPLY VOLTAGE:**  
V<sub>CC</sub> = 2.7 to 3.3 V
- **HIGHER IP<sub>3</sub> AND CONVERSION GAIN:**  
CG = 9.5 dB TYP  
OIP<sub>3</sub> = +7.5 dBm TYP @ f<sub>RFout</sub> = 0.9 GHz
- **HIGH-DENSITY SURFACE MOUNTING:**  
6-pin super minimold package

### DESCRIPTION

The UPC8172TB is a silicon monolithic integrated circuit designed as a frequency up-converter for a wireless transceiver transmitter stage. This IC is manufactured using the 30 GHz f<sub>max</sub> UHS0 (Ultra High Speed Process) silicon bipolar process. This IC has the same circuit current as the conventional UPC8106TB, but operates at higher frequency, higher gain and lower distortion. Such performance and operation from a 3 volts supply makes this device ideal for mobile communications and wireless LAN applications.

Stringent quality assurance and test procedures ensure the highest reliability and performance.

### ELECTRICAL CHARACTERISTICS

(T<sub>A</sub> = 25°C, V<sub>CC</sub> = V<sub>RFOUT</sub> = 3.0 V, f<sub>IFin</sub> = 240 MHz, P<sub>LOin</sub> = -5 dBm, and V<sub>PS</sub> ≥ 2.7 V unless otherwise specified))

PART NUMBER PACKAGE OUTLINE			UPC8172TB S06		
SYMBOLS	PARAMETERS AND CONDITIONS <sup>1</sup>	UNITS	MIN	TYP	MAX
I <sub>CC</sub>	Circuit Current (no signal)	mA	5.5	9.0	13.0
I <sub>CC(PS)</sub>	Circuit Current in Power Save Mode, V <sub>PS</sub> = 0 V	μA	–	–	2
CG1	Conversion Gain,	f <sub>RFout</sub> = 0.9 GHz, P <sub>IFin</sub> = -30 dBm	dB	6.5	12.5
CG2		f <sub>RFout</sub> = 1.9 GHz, P <sub>IFin</sub> = -30 dBm	dB	5.5	11.5
CG3		f <sub>RFout</sub> = 2.4 GHz, P <sub>IFin</sub> = -30 dBm	dB	5.0	11.0
P <sub>O(SAT)1</sub>	Saturated RF Output Power,	f <sub>RFout</sub> = 0.9 GHz, P <sub>IFin</sub> = 0 dBm	dBm	-2.5	–
P <sub>O(SAT)2</sub>		f <sub>RFout</sub> = 1.9 GHz, P <sub>IFin</sub> = 0 dBm	dBm	-3.5	–
P <sub>O(SAT)3</sub>		f <sub>RFout</sub> = 2.4 GHz, P <sub>IFin</sub> = 0 dBm	dBm	-4.0	–
OIP <sub>31</sub>	Output Third-Order Distortion Intercept Point,	f <sub>RFout</sub> = 0.9 GHz	dBm	–	–
OIP <sub>32</sub>		f <sub>RFout</sub> = 1.9 GHz	dBm	–	–
OIP <sub>33</sub>		f <sub>RFout</sub> = 2.4 GHz	dBm	–	–
IIP <sub>31</sub>	Input Third-Order Distortion Intercept Point,	f <sub>RFout</sub> = 0.9 GHz	dBm	–	–
IIP <sub>32</sub>		f <sub>RFout</sub> = 1.9 GHz	dBm	–	–
IIP <sub>33</sub>		f <sub>RFout</sub> = 2.4 GHz	dBm	–	–
SSB·NF1	SSB Noise Figure,	f <sub>RFout</sub> = 0.9 GHz, f <sub>IFin</sub> = 240 MHz	dB	–	–
SSB·NF2		f <sub>RFout</sub> = 1.9 GHz, f <sub>IFin</sub> = 240 MHz	dB	–	–
SSB·NF3		f <sub>RFout</sub> = 2.4 GHz, f <sub>IFin</sub> = 240 MHz	dB	–	–
TPS(rise)	Power Save Response Time	Rise Time, V <sub>PS</sub> : GND' V <sub>CC</sub>	μs	–	–
TPS(fall)		Fall Time, V <sub>PS</sub> : V <sub>CC</sub> ' GND	μs	–	–

Note:

1. f<sub>RFout</sub> < f<sub>LOin</sub> @ f<sub>RFout</sub> = 0.9 GHz  
f<sub>LOin</sub> < f<sub>RFout</sub> @ f<sub>RFout</sub> = 1.9 GHz/2.4 GHz

### BLOCK DIAGRAM

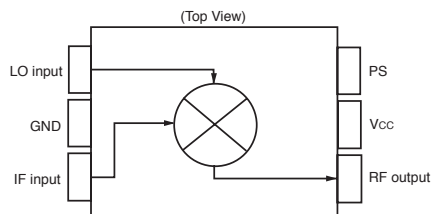

### APPLICATIONS

- PCS1900 MHz
- 2.4 GHz band transmitter/receiver system (wireless LAN, etc.)

# UPC8172TB

## ABSOLUTE MAXIMUM RATINGS<sup>1</sup>

(T<sub>A</sub> = +25°C unless otherwise specified)

SYMBOLS	PARAMETERS	UNITS	RATINGS
V <sub>CC</sub>	Supply Voltage	V	3.6
V <sub>PS</sub>	PS Pin Input Voltage	V	3.6
P <sub>D</sub>	Power Dissipation <sup>2</sup>	mW	270
T <sub>A</sub>	Operating Ambient Temperature	°C	-40 to +85
T <sub>STG</sub>	Storage Temperature	°C	-55 to +150
P <sub>IN</sub>	Input Power	dBm	+10

Notes:

- Operation in excess of any one of these conditions may result in permanent damage.
- Mounted on a double-sided copper clad 50x50x1.6 mm epoxy glass PWB, T<sub>A</sub> = +85°C.

## RECOMMENDED OPERATING CONDITIONS

SYMBOLS	PARAMETERS	UNITS	MIN	TYP	MAX
V <sub>CC</sub>	Supply Voltage <sup>1</sup>	V	2.7	3.0	3.3
T <sub>A</sub>	Operating Ambient Temperature	°C	-40	+25	+85
P <sub>LOin</sub>	Local Input Level <sup>2</sup>	dBm	-10	-5	0
f <sub>RFout</sub>	RF Output Frequency <sup>3</sup>	GHz	0.8	–	2.5
f <sub>iFin</sub>	IF Input Frequency	MHz	50	–	400

Note:

- Same voltage applied to pins 5 and 6.
- Z<sub>s</sub> = 50 Ω (without matching).
- With external matching circuit.

## SERIES PRODUCTS<sup>1</sup> (T<sub>A</sub> = +25°C, V<sub>CC</sub> = V<sub>RFout</sub> = 3.0 V, Z<sub>S</sub> = Z<sub>L</sub> = 50 Ω)

Part Number	I <sub>CC</sub> (mA)	f <sub>RFout</sub> (GHz)	CG (dB)			OIP <sub>3</sub> (dBm)		
			@RF 0.9 GHz <sup>2</sup>	@RF 1.9 GHz	@RF 2.4 GHz	@RF 0.9 GHz <sup>2</sup>	@RF 1.9 GHz	@RF 2.4 GHz
UPC8172TB	9	0.8 to 2.5	9.5	8.5	8.0	+7.5	+6.0	+4.0
UPC8106TB	9	0.4 to 2.0	9	7	–	+5.5	-1.0	–
UPC8109TB	5	0.4 to 2.0	6	4	–	+1.5	+2.0	–
UPC8163TB	16.5	0.8 to 2.0	9	5.5	–	+9.5	+6.0	–

Notes:

- Typical performance.
- f<sub>RFout</sub> = 0.83 GHz @ UPC8163TB

## PIN FUNCTIONS (Voltage is measured at V<sub>CC</sub> = V<sub>PS</sub> = V<sub>RFOUT</sub> = 3.0 V)

Pin No.	Pin Name	Applied Voltage (V)	Pin Voltage (V)	Function and Explanation	Equivalent Circuit						
1	IFinput	–	1.4	This pin is the IF input pin to the double balanced mixer (DBM). The input is designed as a high impedance. The circuit helps suppress spurious signals. Also this symmetrical circuit can keep specified performance insensitive to process-condition distribution. For that reason, a double balanced mixer is adopted.							
2	GND	GND	–	GND pin. Ground pattern on the board should be formed as wide as possible. Track length should be kept as short as possible to minimize ground inductance.							
3	LOinput	–	2.3	Local input pin. Recommendable input level is -10 to 0 dBm.							
5	V <sub>CC</sub>	2.7 to 3.3	–	Supply voltage pin.							
6	RFoutput	Same bias as V <sub>CC</sub> through external inductor	–	This pin is the RF output from the double balanced mixer. This pin is designed as an open collector. Due to the high impedance output, this pin should be externally equipped with an LC matching circuit to the next stage.							
4	PS	V <sub>CC</sub> /GND	–	Power save control pin. Bias controls operate as follows: <table border="1" style="margin: 10px auto;"> <thead> <tr> <th>Pin Bias</th> <th>Control</th> </tr> </thead> <tbody> <tr> <td>V<sub>CC</sub></td> <td>Operation</td> </tr> <tr> <td>GND</td> <td>Power Save</td> </tr> </tbody> </table>	Pin Bias	Control	V <sub>CC</sub>	Operation	GND	Power Save	
Pin Bias	Control										
V <sub>CC</sub>	Operation										
GND	Power Save										

**TYPICAL PERFORMANCE CURVES** (TA = 25°C)

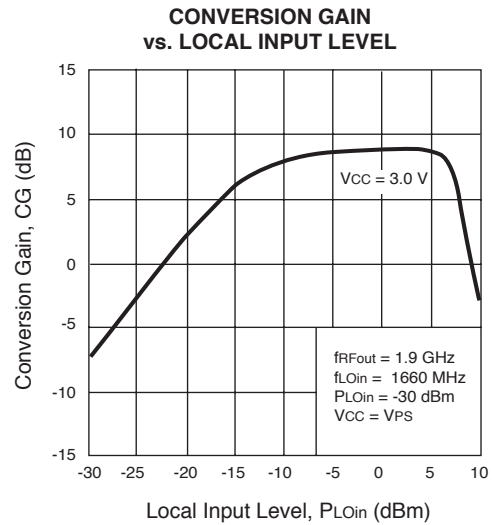
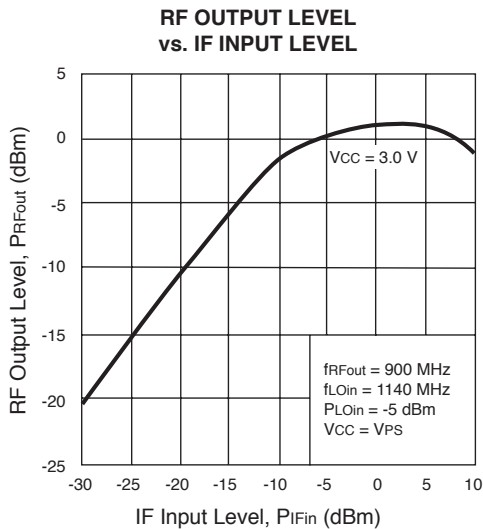
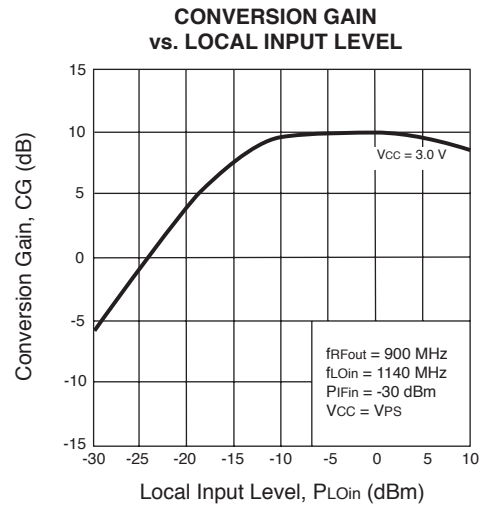
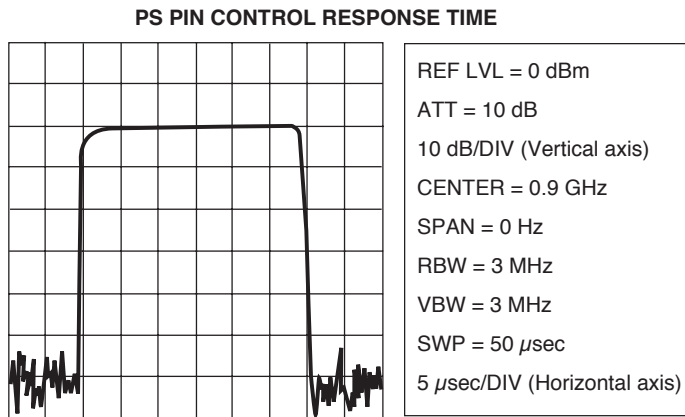
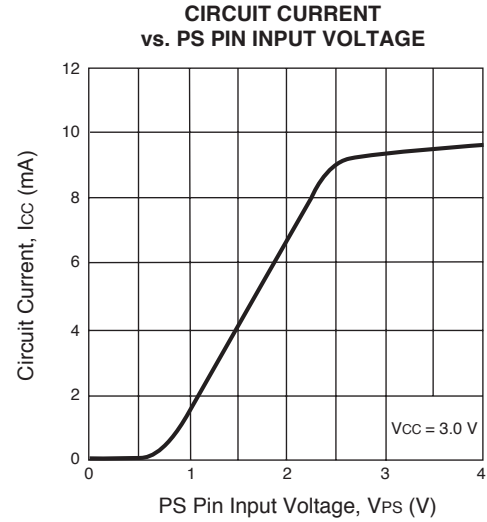
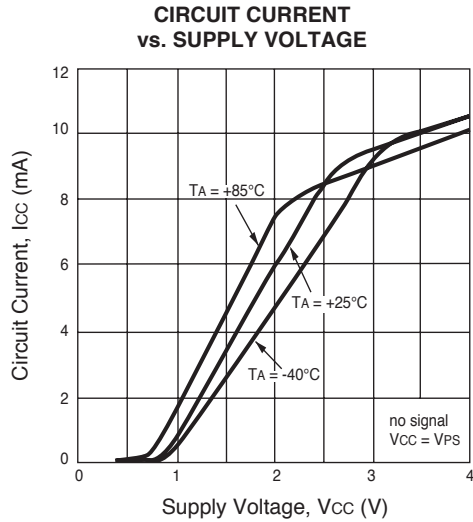

TYPICAL PERFORMANCE CURVES (TA = 25°C)

RF OUTPUT LEVEL vs. IF INPUT LEVEL

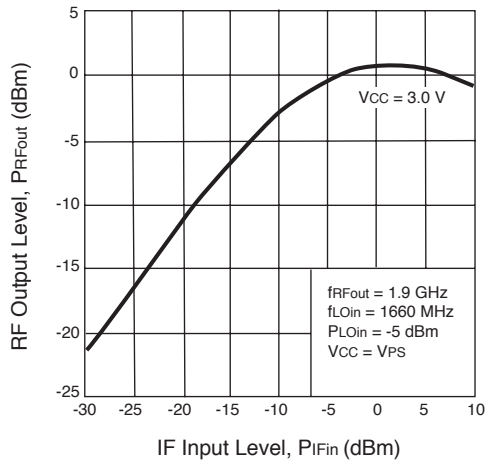

CONVERSION GAIN vs. LOCAL INPUT LEVEL

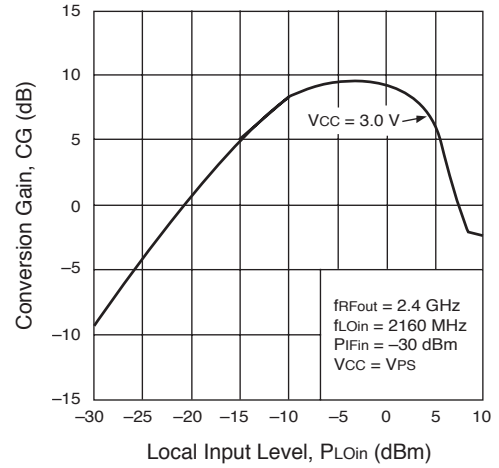

RF OUTPUT LEVEL vs. IF INPUT LEVEL

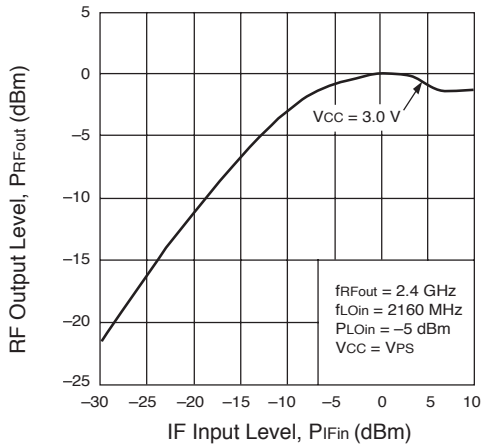

IM3, RF OUTPUT LEVEL vs. IF INPUT LEVEL

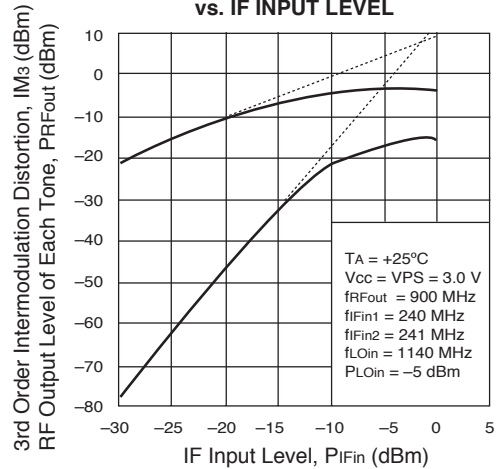

IM3, RF OUTPUT LEVEL vs. IF INPUT LEVEL

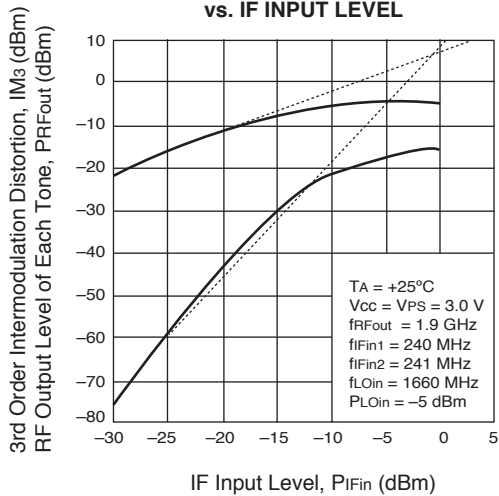

IM3, RF OUTPUT LEVEL vs. IF INPUT LEVEL

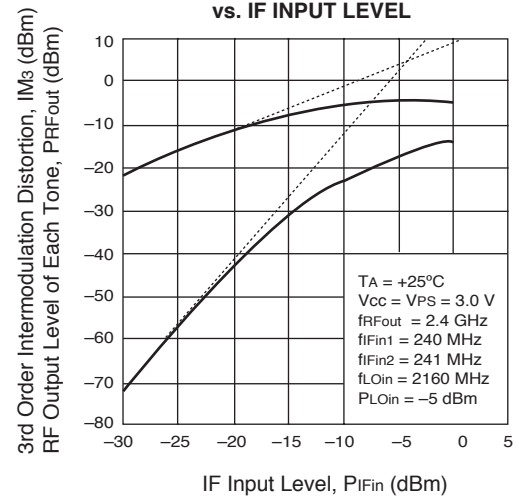

**TYPICAL PERFORMANCE CURVES** (TA = 25°C)

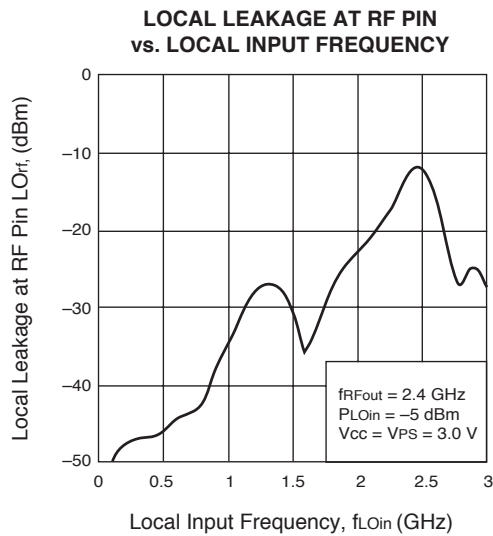
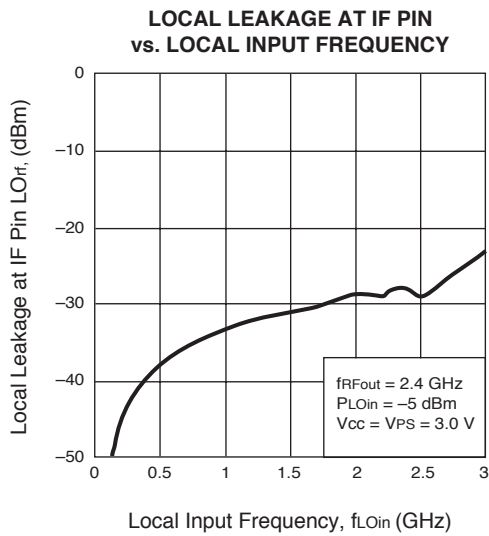
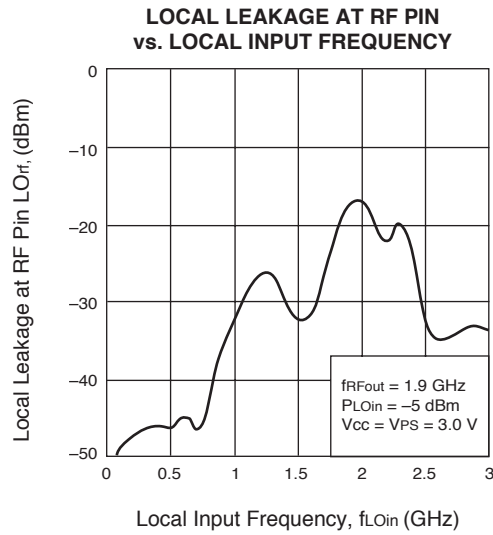
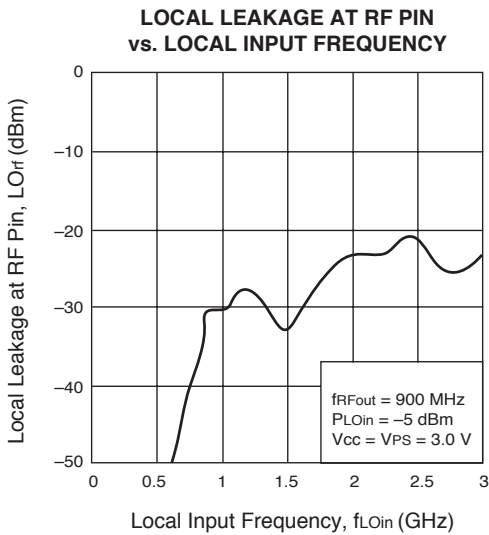
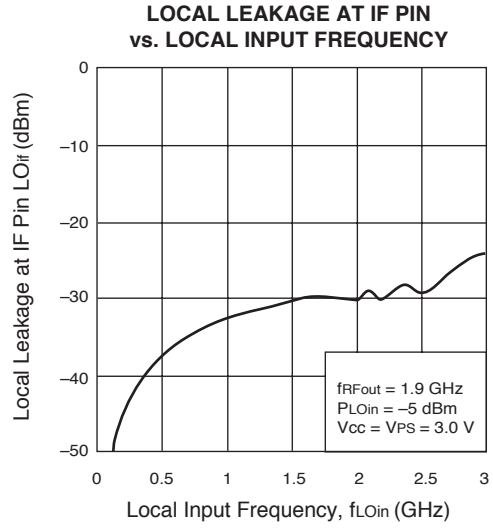
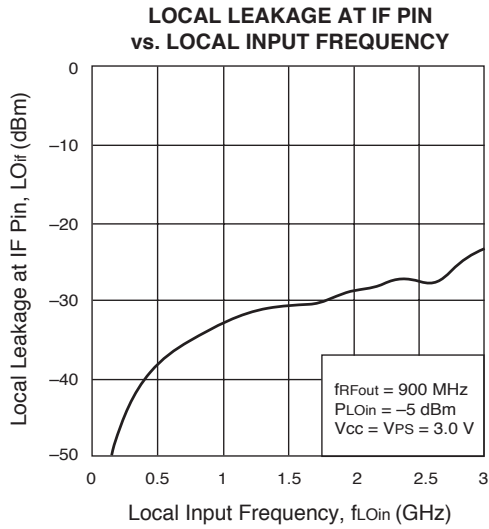

# UPC8172TB

## SYSTEM APPLICATION EXAMPLE

Wireless Transceiver

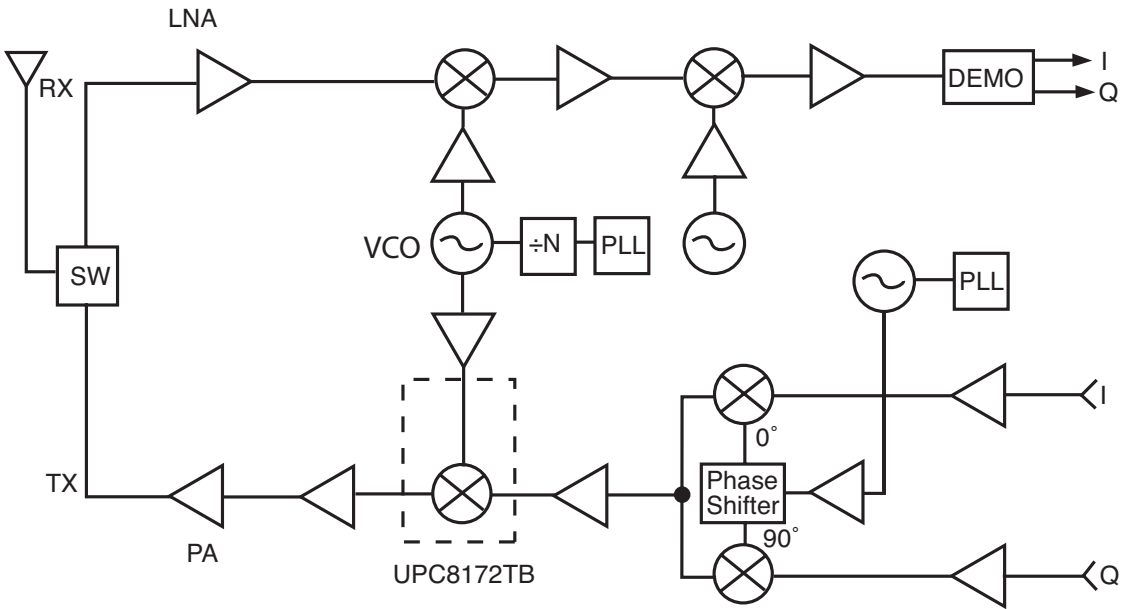

**S-PARAMETERS FOR EACH PORT** ( $V_{CC} = V_{PS} = V_{RFout} = 3.0\text{ V}$ )

(The paramters are monitored at DUT pins)

LO port

S<sub>11</sub> Z  
 REF 1.0 Units  
 1 200.0 mUnits/  
 ▽ 21.625 Ω -91.148 Ω

hp  
 MARKER 1  
 1.15 GHz  
 MARKER 2  
 1.65 GHz  
 MARKER 3  
 2.15 GHz

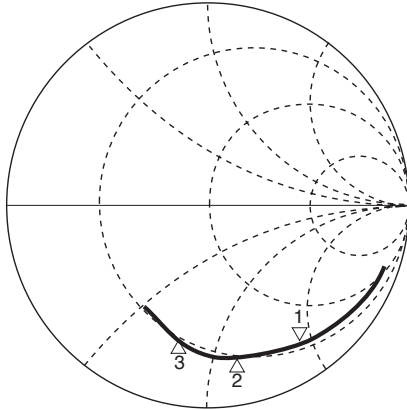

START 0.40000000 GHz  
 STOP 2.50000000 GHz

RF port (without matching)

S<sub>22</sub> Z  
 REF 1.0 Units  
 1 200.0 mUnits/  
 ▽ 71.5 Ω -240.34 Ω

hp  
 MARKER 1  
 900 MHz  
 MARKER 2  
 1.9 GHz  
 MARKER 3  
 2.5 GHz

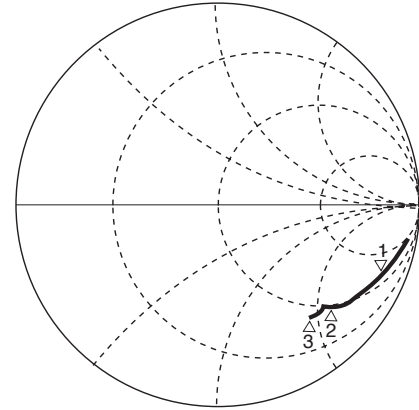

START 0.40000000 GHz  
 STOP 2.50000000 GHz

IF port

S<sub>11</sub> Z  
 REF 1.0 Units  
 1 200.0 mUnits/  
 ▽ 332.63 Ω -601.34 Ω

hp  
 MARKER 1  
 240.0 MHz

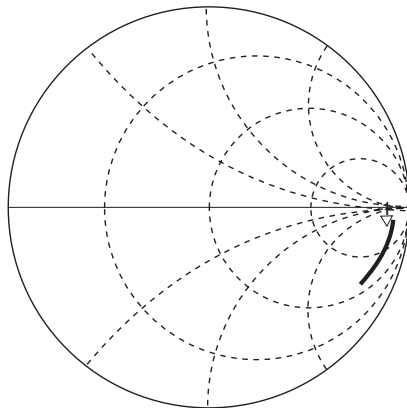

START 0.10000000 GHz  
 STOP 1.00000000 GHz

**TEST CIRCUIT 1** ( $f_{RFout} = 900 \text{ MHz}$ )

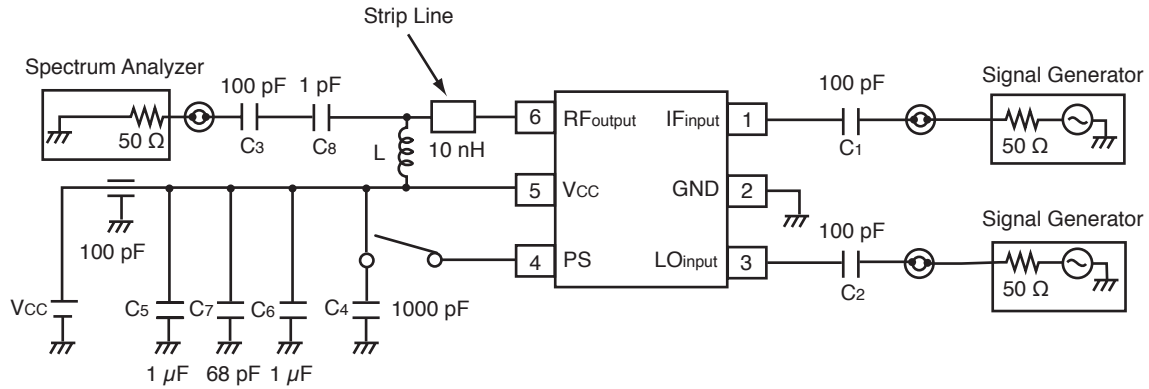

**EXAMPLE OF TEST CIRCUIT 1 ASSEMBLED ON EVALUATION BOARD**

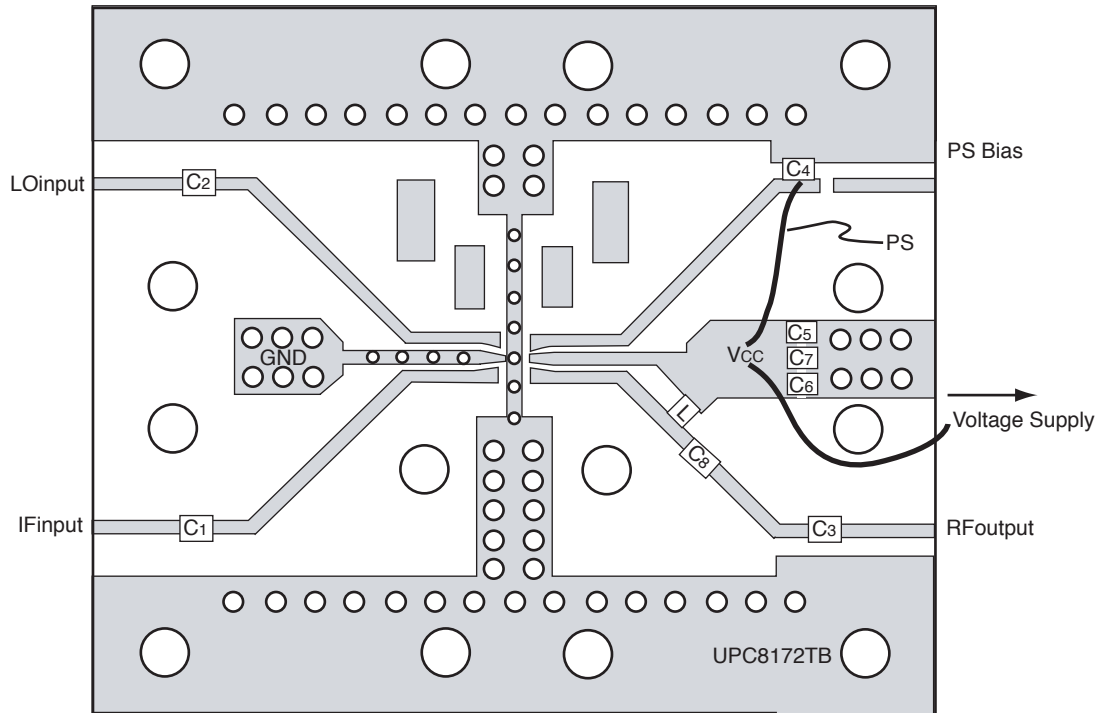

**COMPONENT LIST**

FORM	SYMBOL	VALUE
Chip Capacitor	C1, C2, C3	100 pF
	C4	1000 pF
	C5, C6	1 μF
	C7	68 pF
	C8	1 pF
	Chip Inductor	L

- (\*1) 35x42x0.4 mm polyimide board, double-sided copper clad
- (\*2) Ground pattern on rear of the board
- (\*3) Solder plated patterns
- (\*4)  $\text{mm}\text{III}$ : Through holes

Note:  
1. 10 nH: LL1608-FH10N (TOKO Co., Ltd.)



**TEST CIRCUIT 2** ( $f_{RFout} = 1.9\text{ GHz}$ )

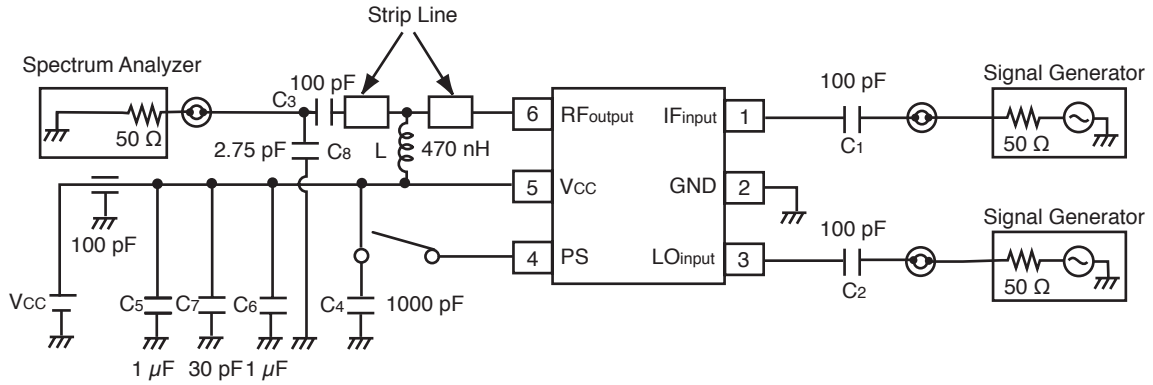

**EXAMPLE OF TEST CIRCUIT 2 ASSEMBLED ON EVALUATION BOARD**

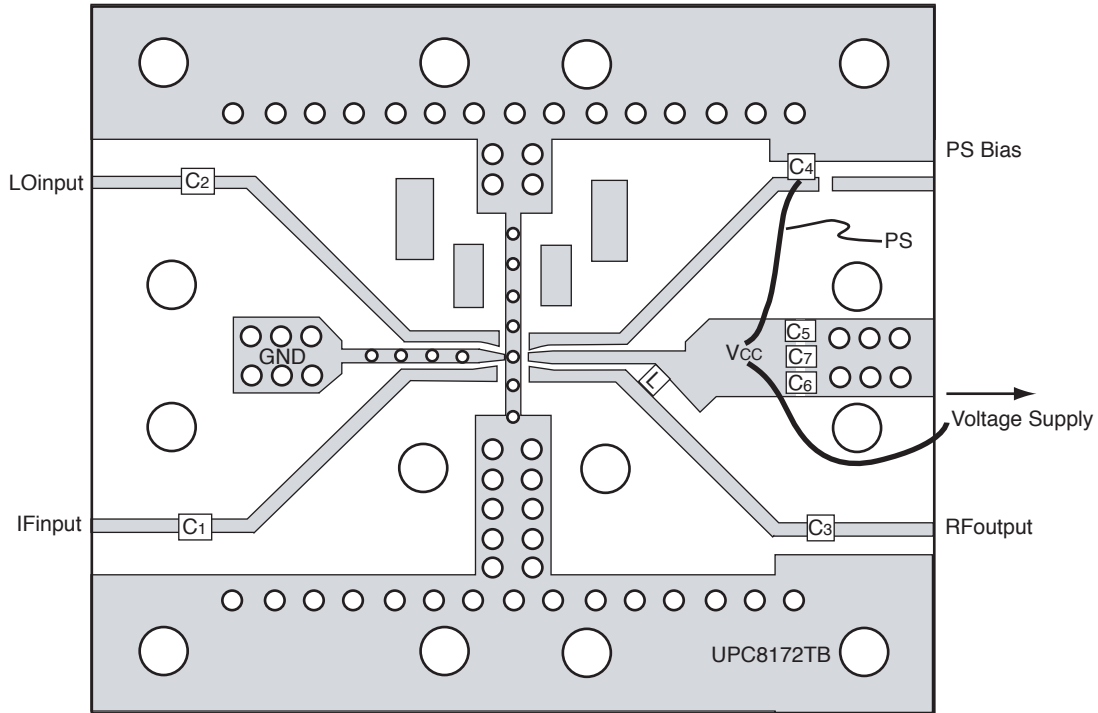

**COMPONENT LIST**

FORM	SYMBOL	VALUE
Chip Capacitor	C1, C2, C3	100 pF
	C4	1000 pF
	C5, C6	1 $\mu$ F
	C7	30 pF
	C8	2.75 pF
Chip Inductor	L	470 nH <sup>1</sup>

- (\*1) 35 x 42 x 0.4 mm polyimide board, double-sided copper clad
- (\*2) Ground pattern on rear of the board
- (\*3) Solder plated patterns
- (\*4)  $\text{mm}\text{I}$ : Through holes

Note:

1. 470 nH: LL2012-FR47 (TOKO Co., Ltd.)

**TEST CIRCUIT 3** ( $f_{RFout} = 2.4 \text{ GHz}$ )

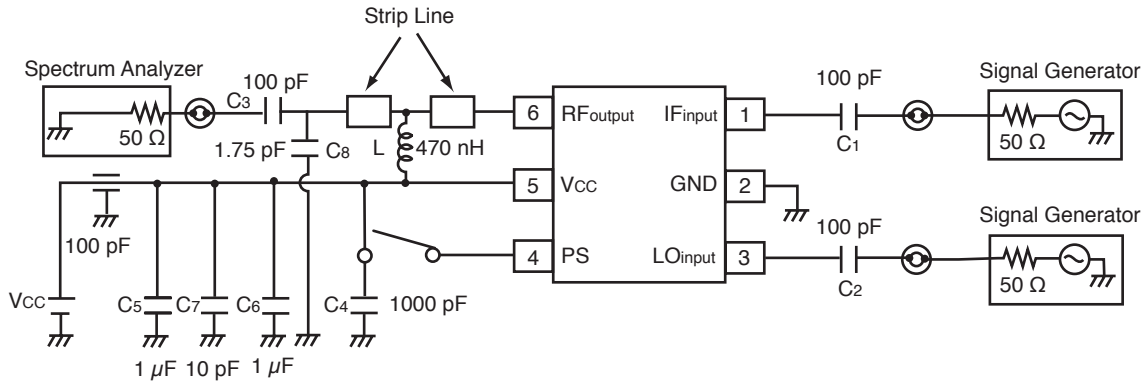

**EXAMPLE OF TEST CIRCUIT 3 ASSEMBLED ON EVALUATION BOARD**

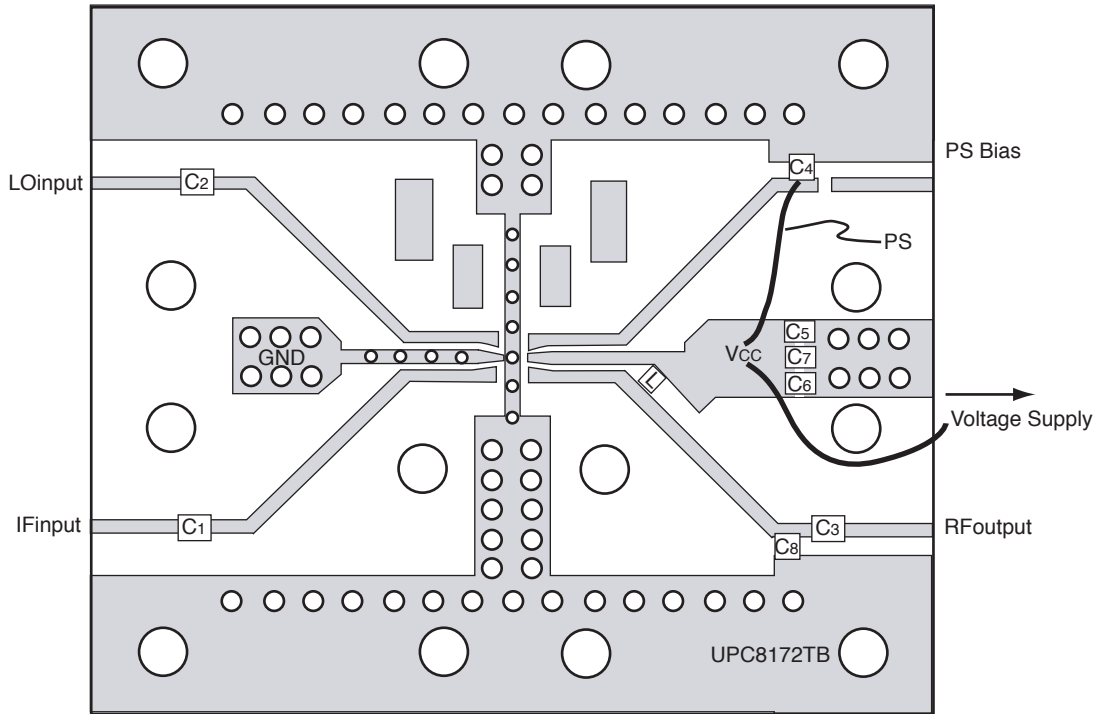

**COMPONENT LIST**

FORM	SYMBOL	VALUE
Chip Capacitor	C1, C2, C3	100 pF
	C4	1000 pF
	C5, C6	1 $\mu$ F
	C7	10 pF
	C8	1.75 pF
	Chip Inductor	L

- (\*1) 35 x 42 x 0.4 mm polyimide board, double-sided copper clad
- (\*2) Ground pattern on rear of the board
- (\*3) Solder plated patterns
- (\*4)  $\text{mm}\text{M}$ : Through holes

Note:

1. 470 nH: LL2012-FR47 (TOKO Co., Ltd.)

**OUTLINE DIMENSIONS** (Units in mm)

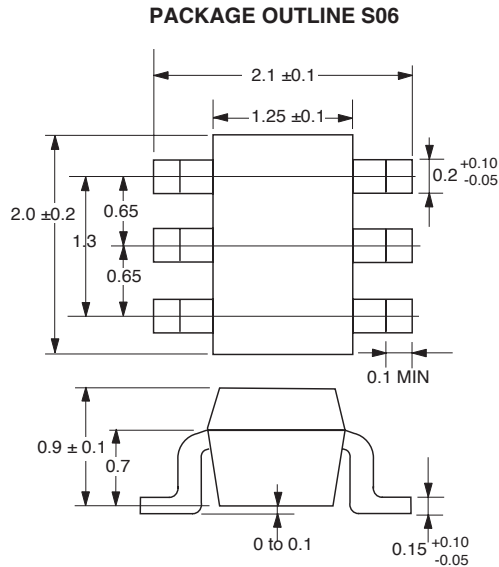

Note:  
All dimensions are typical unless otherwise specified.

**BLOCK DIAGRAM**

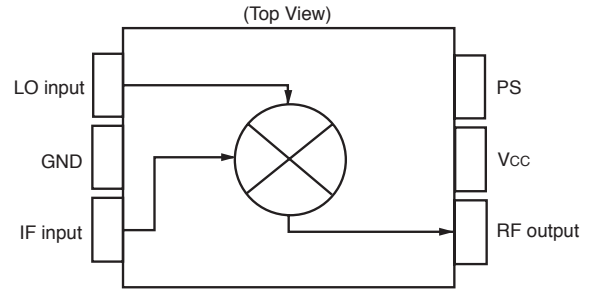

**PIN CONNECTIONS**

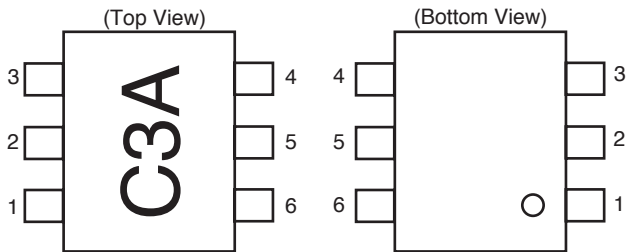

PIN NO.	PIN NAME
1	IFinput
2	GND
3	LOinput
4	PS
5	Vcc
6	RFoutput

**ORDERING INFORMATION**

Part Number	Quantity
UPC8172TB-E3-A	3 K pcs/reel

Note: Embossed tape, 8 mm wide. Pins 1, 2 and 3 face the tape perforation side.

EXCLUSIVE NORTH AMERICAN AGENT FOR RF, MICROWAVE & OPTOELECTRONIC SEMICONDUCTORS

**CEL** CALIFORNIA EASTERN LABORATORIES • Headquarters • 4590 Patrick Henry Drive • Santa Clara, CA 95054-1817 • (408) 988-3500 • Telex 34-6393 • FAX (408) 988-0279  
24-Hour Fax-On-Demand: 800-390-3232 (U.S. and Canada only) • Internet: <http://WWW.CEL.COM>

DATA SUBJECT TO CHANGE WITHOUT NOTICE

06/14/2001