

# "High Frequency Ceramic Solutions"

## 2.4GHz High Rejection BPF with LGA-type terminations for P/N 2450BP15Q0100 reduced effective footprint

Detail Specification: 6/19/2013

Page 1 of 2

General Specifications	
Part Number	2450BP15Q0100
Frequency (MHz)	2400 ~ 2500
Attenuation (dB)	35 min. @ 824 ~ 960MHz
	30 min. @ 1545 ~ 1605MHz
	35 min. @ 1710 ~ 1990MHz
	30 min. @ 2170MHz
	30 min. @ 4800 ~ 5000MHz
	25 min. @ 7200 ~ 7500MHz
Insertion Loss (dB)	1.8 max. @ 25 °C 2.0 max. @ -40~85 °C
Return Loss (dB)	10 min
Power Capacity	2 Watts max. (CW)

Operating Temperature	-40 to +85°C
Recommended Storage Conditions	+5 to +35°C, Humidity 45~75%RH, 18 months, 1 week max after opened*
Reel Quantity	4,000
Solder Paste	SAC 305 type is recommended.

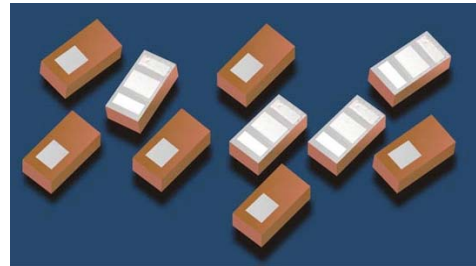

### Part Number Explanation

P/N Suffix	Packing Style	Bulk	Suffix = S	eg. 2450BP15Q0100S
		T & R	Suffix = E	eg. 2450BP15Q0100E
	Termination style	100% Tin	Suffix = None	eg. 2450BP15Q0100 (E or S)
	50 ohm Evaluation Board	2450BP15Q0100-EBSMA (with SMA Connectors)		

### Mechanical Dimensions

	In	mm
L	0.079 ± 0.006	2.0 ± 0.15
W	0.049 ± 0.004	1.25 ± 0.10
T	0.028 Max.	0.70 Max.
a	0.037 ± 0.004	0.95 ± 0.10
b	0.011 ± 0.004	0.275 ± 0.10
c	0.024 ± 0.004	0.6 ± 0.10
d	0.010 ± 0.002	0.25 ± 0.05

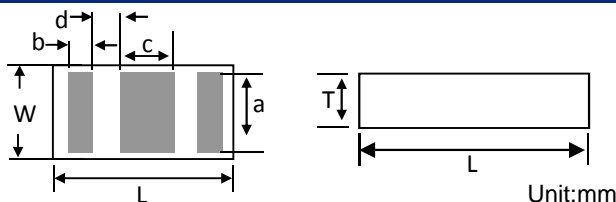

### Terminal Configuration

No.	Function
1	I/O
2	GND
3	I/O

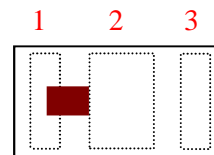

Pins 1 and 3 are interchangeable (symmetrical component)

Pins 1 and 3 have a DC path to Pin 2

If DC block required, a 10pF - 15pF low loss cap should be mounted at the I/O's

\*For more info go to [www.johansonstechnology.com/silverleads](http://www.johansonstechnology.com/silverleads)



[www.johansonstechnology.com](http://www.johansonstechnology.com)

4001 Calle Tecate • Camarillo, CA 93012 • TEL 805.389.1166 FAX 805.389.1821

Ver 1.2

2013 Johanson Technology, Inc. All Rights Reserved

# "High Frequency Ceramic Solutions"

**2.4GHz High Rejection BPF with LGA-type terminations for reduced effective footprint**

**P/N 2450BP15Q0100**



Detail Specification: 6/19/2013

Page 2 of 2

## Mounting Considerations

\*Line width should be designed to match 50  $\Omega$  characteristic impedance, depending on PCB material and thickness.

### LEGEND

-  Solder
-  Land
-  Through-hole ( $\phi 0.3$ )

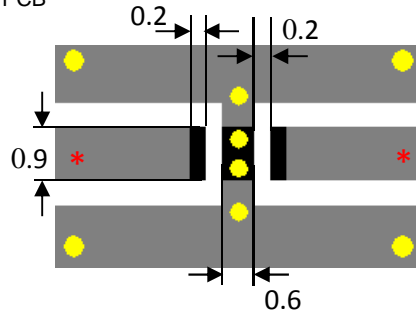

## Measuring Diagram

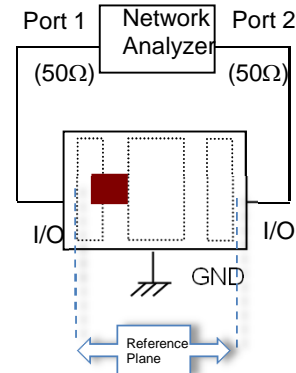

## Typical Electrical Performance (T=25°C)

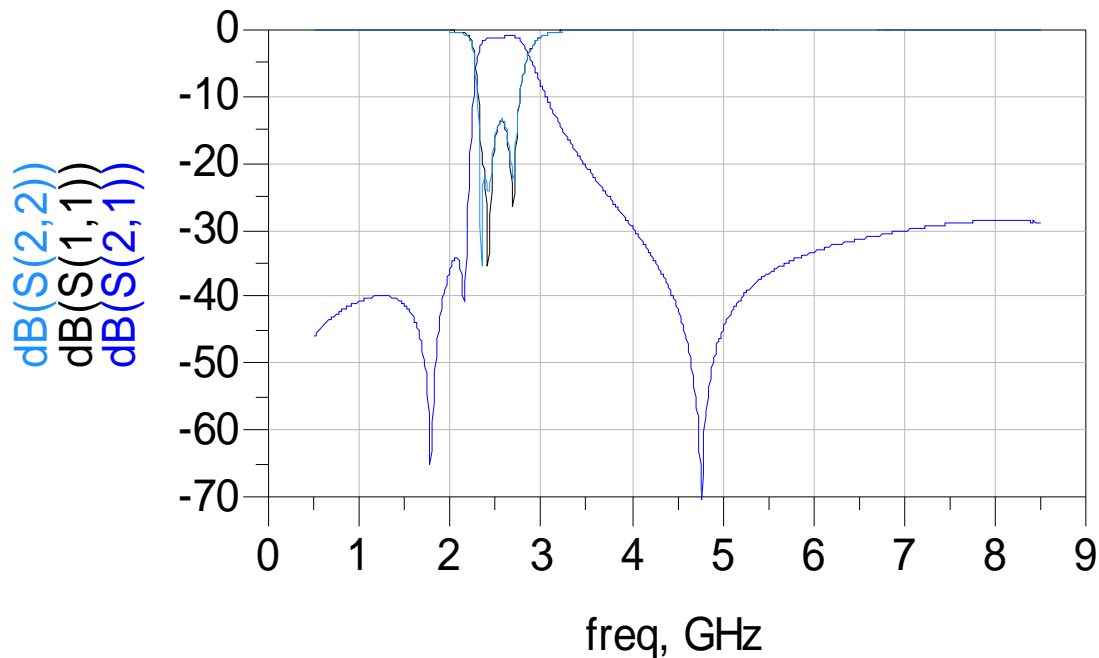

Johanson Technology, Inc. reserves the right to make design changes without notice. Please confirm the specifications and delivery conditions when placing your order. All sales are subject to Johanson Technology, Inc. terms and conditions.



[www.johansontechnology.com](http://www.johansontechnology.com)

4001 Calle Tecate • Camarillo, CA 93012 • TEL 805.389.1166 FAX 805.389.1821

Ver 1.2

2013 Johanson Technology, Inc. All Rights Reserved

# "High Frequency Ceramic Solutions"

**2.4GHz High Rejection BPF with LGA-type terminations for reduced effective footprint** **P/N 2450BP15Q0100**

Detail Specification: 6/19/2013

Page 2 of 2

## Tape & Reel Specifications

<http://www.johansontechnology.com/ipcpackaging.html>

## Soldering Profile

<http://www.johansontechnology.com/ipcsoldering-profile>

## Representative Schematic for 2450BP15Q100

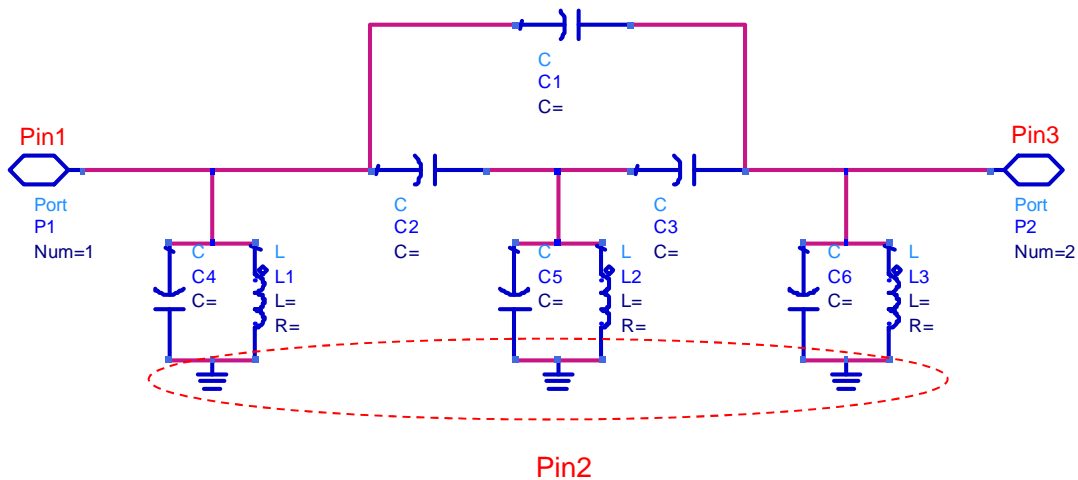

Note: If the designer needs to block DC signals a 10-12pF low loss cap is recommended. The following p/n's are recommended:

250R05L100JV4T	500R07S100JV4T
250R05L110JV4T	500R07S110JV4T
250R05L120JV4T	500R07S120JV4T

<http://www.johansontechnology.com/rf-capacitors/high-q-multi-layer-capacitors-rohs.html>

Johanson Technology, Inc. reserves the right to make design changes without notice. Please confirm the specifications and delivery conditions when placing your order. All sales are subject to Johanson Technology, Inc. terms and conditions.



[www.johansontechnology.com](http://www.johansontechnology.com)

4001 Calle Tecate • Camarillo, CA 93012 • TEL 805.389.1166 FAX 805.389.1821

Ver 1.2

2013 Johanson Technology, Inc. All Rights Reserved