

# NLX3G16

## Triple Non-Inverting Buffer

The NLX3G16 MiniGate™ is an advanced high-speed CMOS triple non-inverting buffer in ultra-small footprint.

The NLX3G16 input and output structures provide protection when voltages up to 7.0 V are applied, regardless of the supply voltage.

### Features

- High Speed:  $t_{PD} = 1.8 \text{ ns (Typ) @ } V_{CC} = 5.0 \text{ V}$
- Designed for 1.65 V to 5.5 V  $V_{CC}$  Operation
- Low Power Dissipation:  $I_{CC} = 1 \mu\text{A (Max) at } T_A = 25^\circ\text{C}$
- 24 mA Balanced Output Source and Sink Capability
- Balanced Propagation Delays
- Overvoltage Tolerant (OVT) Input and Output Pins
- Ultra-Small Packages
- These are Pb-Free Devices

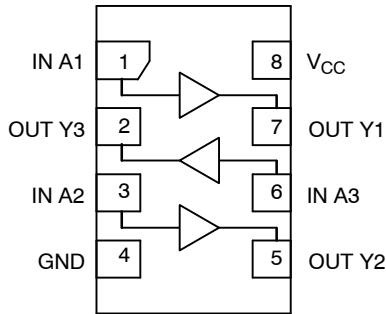

Figure 1. Pinout (Top View)

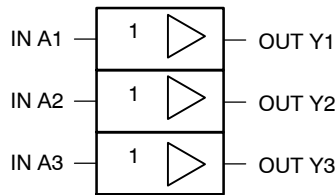

Figure 2. Logic Symbol

### PIN ASSIGNMENT

1	IN A1
2	OUT Y3
3	IN A2
4	GND
5	OUT Y2
6	IN A3
7	OUT Y1
8	$V_{CC}$

### FUNCTION TABLE

A	Y
L	L
H	H



ON Semiconductor®

<http://onsemi.com>

### MARKING DIAGRAMS



ULLGA8  
1.45 x 1.0  
CASE 613AA

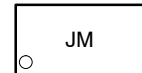

ULLGA8  
1.6 x 1.0  
CASE 613AB



ULLGA8  
1.95 x 1.0  
CASE 613AC

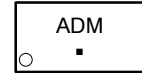

UDFN8  
1.45 x 1.0  
CASE 517BZ

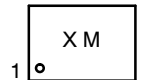

UDFN8  
1.6 x 1.0  
CASE 517BY

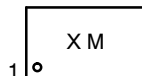

UDFN8  
1.95 x 1.0  
CASE 517CA

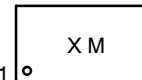

J or AD = Specific Device Code  
M = Date Code  
▪ = Pb-Free Package

### ORDERING INFORMATION

See detailed ordering and shipping information in the package dimensions section on page 5 of this data sheet.

# NLX3G16

## MAXIMUM RATINGS

Symbol	Parameter	Value	Unit
V <sub>CC</sub>	DC Supply Voltage	-0.5 to +7.0	V
V <sub>IN</sub>	DC Input Voltage	-0.5 to +7.0	V
V <sub>OUT</sub>	DC Output Voltage	-0.5 to +7.0	V
I <sub>IK</sub>	DC Input Diode Current V <sub>IN</sub> < GND	-50	mA
I <sub>OK</sub>	DC Output Diode Current V <sub>OUT</sub> < GND	-50	mA
I <sub>O</sub>	DC Output Source/Sink Current	±50	mA
I <sub>CC</sub>	DC Supply Current Per Supply Pin	±100	mA
I <sub>GND</sub>	DC Ground Current per Ground Pin	±100	mA
T <sub>STG</sub>	Storage Temperature Range	-65 to +150	°C
T <sub>L</sub>	Lead Temperature, 1 mm from Case for 10 Seconds	260	°C
T <sub>J</sub>	Junction Temperature Under Bias	150	°C
MSL	Moisture Sensitivity	Level 1	
F <sub>R</sub>	Flammability Rating Oxygen Index: 28 to 34	UL 94 V-0 @ 0.125 in	
I <sub>LATCHUP</sub>	Latchup Performance Above V <sub>CC</sub> and Below GND at 125 °C (Note 5)	±500	mA

Stresses exceeding Maximum Ratings may damage the device. Maximum Ratings are stress ratings only. Functional operation above the Recommended Operating Conditions is not implied. Extended exposure to stresses above the Recommended Operating Conditions may affect device reliability.

1. Measured with minimum pad spacing on an FR4 board, using 10 mm-by-1 inch, 2 ounce copper trace no air flow.
2. Tested to EIA/JESD22-A114-A.
3. Tested to EIA/UESD22-A115-A.
4. Tested to JESD22-C101-A.
5. Tested to EIA / JESD78.

## RECOMMENDED OPERATING CONDITIONS

Symbol	Parameter	Min	Max	Unit
V <sub>CC</sub>	Positive DC Supply Voltage	1.65	5.5	V
V <sub>IN</sub>	Digital Input Voltage	0	5.5	V
V <sub>OUT</sub>	Output Voltage	0	5.5	V
T <sub>A</sub>	Operating Free-Air Temperature	-55	+125	°C
Δt/ΔV	Input Transition Rise or Fall Rate V <sub>CC</sub> = 1.8 V ± 0.18 V <sub>CC</sub> = 2.5 V ± 0.2 V V <sub>CC</sub> = 3.3 V ± 0.3 V V <sub>CC</sub> = 5.0 V ± 0.5 V	0	20	ns/V
		0	20	
		0	10	
		0	5	

# NLX3G16

## DC ELECTRICAL CHARACTERISTICS

Symbol	Parameter	Conditions	V <sub>CC</sub> (V)	T <sub>A</sub> = 25 °C			T <sub>A</sub> = +85°C		T <sub>A</sub> = -55°C to +125°C		Unit
				Min	Typ	Max	Min	Max	Min	Max	
V <sub>IH</sub>	Low-Level Input Voltage		1.65 to 5.5	0.70 x V <sub>CC</sub>			0.70 x V <sub>CC</sub>				V
V <sub>IL</sub>	Low-Level Input Voltage		1.65 to 5.5			0.30 x V <sub>CC</sub>		0.30 x V <sub>CC</sub>		0.30 x V <sub>CC</sub>	V
V <sub>OH</sub>	High-Level Output Voltage	V <sub>IN</sub> = V <sub>IH</sub> or V <sub>IL</sub> I <sub>OH</sub> = -100 μA	1.65 to .5	V <sub>CC</sub> - 0.1	V <sub>CC</sub>		V <sub>CC</sub> - 0.1		V <sub>CC</sub> - 0.1		V
		V <sub>IN</sub> = V <sub>IH</sub> or V <sub>IL</sub> I <sub>OH</sub> = -4 mA	1.65	1.4	1.50		1.4		1.4		
		I <sub>OH</sub> = -8 mA	2.3	1.9	2.1		1.9		1.9		
		I <sub>OH</sub> = -12 mA	2.7	2.2	2.4		2.2		2.2		
		I <sub>OH</sub> = -16 mA	3.0	2.4	2.7		2.4		2.4		
		I <sub>OH</sub> = -24 mA	3.0	2.3	2.5		2.3		2.3		
I <sub>OH</sub> = -32 mA	4.5	3.8	4.0		3.8		3.8				
V <sub>OL</sub>	Low-Level Output Voltage	V <sub>IN</sub> = V <sub>IH</sub> or V <sub>IL</sub> I <sub>OL</sub> = 100 μA	1.65 - 5.5			0.1		0.1		0.1	V
		V <sub>IN</sub> = V <sub>IH</sub> or V <sub>IL</sub> I <sub>OH</sub> = 4 mA	1.65		0.2	0.24		0.24		0.24	
		I <sub>OH</sub> = 8 mA	2.3		0.2	0.3		0.3		0.3	
		I <sub>OH</sub> = 12 mA	2.7		0.22	0.4		0.4		0.4	
		I <sub>OH</sub> = 16 mA	3.0		0.28	0.4		0.4		0.4	
		I <sub>OH</sub> = 24 mA	3.0		0.38	0.55		0.55		0.55	
I <sub>OH</sub> = 32 mA	4.5		0.42	0.55		0.55		0.55			
I <sub>IN</sub>	Input Leakage Current	0 ≤ V <sub>IN</sub> ≤ 5.5 V	0 to 5.5			±0.1		±1.0		±1.0	μA
I <sub>OFF</sub>	Power-Off Output Leakage Current	V <sub>IN</sub> or V <sub>OUT</sub> = 5.5 V	0			1.0		10		10	μA
I <sub>CC</sub>	Quiescent Supply Current	0 ≤ V <sub>IN</sub> ≤ V <sub>CC</sub>	5.5			1.0		10		10	μA

# NLX3G16

## AC ELECTRICAL CHARACTERISTICS (Input $t_r = t_f = 3.0$ nS)

Symbol	Parameter	V <sub>CC</sub> (V)	Test Condition	T <sub>A</sub> = 25 °C			T <sub>A</sub> = +85°C		T <sub>A</sub> = -55°C to +125°C		Unit
				Min	Typ	Max	Min	Max	Min	Max	
t <sub>PLH</sub> , t <sub>PHL</sub>	Propagation Delay Input A to Output	1.65–1.95	R <sub>L</sub> = 1 MΩ, C <sub>L</sub> = 15 pF	1.8	6.0	7.9	1.8	8.8	1.8	12	ns
		2.3–2.7	R <sub>L</sub> = 1 MΩ, C <sub>L</sub> = 15 pF	1.0	3.0	5.2	1.0	5.8	1.0	9.1	
		3.0–3.6	R <sub>L</sub> = 1 MΩ, C <sub>L</sub> = 15 pF	0.8	2.3	3.6	0.8	4.0	0.8	6.5	
			R <sub>L</sub> = 500 Ω, C <sub>L</sub> = 50 pF	1.2	3.0	4.6	1.2	5.1	1.2	7.6	
		4.5–5.5	R <sub>L</sub> = 1 MΩ, C <sub>L</sub> = 15 pF	0.5	1.8	2.9	0.5	3.2	0.5	5.5	
			R <sub>L</sub> = 500 Ω, C <sub>L</sub> = 50 pF	0.8	2.4	3.8	0.8	4.2	0.8	6.4	
C <sub>IN</sub>	Input Capacitance	5.5	V <sub>IN</sub> = 0 V or V <sub>CC</sub>		7.0					pF	
C <sub>PD</sub>	Power Dissipation Capacitance (Note 6)	3.3 5.5	10 MHz V <sub>IN</sub> = 0 V or V <sub>CC</sub>		9 11					pF	

6. C<sub>PD</sub> is defined as the value of the internal equivalent capacitance which is calculated from the dynamic operating current consumption without load. Average operating current can be obtained by the equation  $I_{CC(OPR)} = C_{PD} \cdot V_{CC} \cdot f_{in} + I_{CC}$ . C<sub>PD</sub> is used to determine the no-load dynamic power consumption:  $P_D = C_{PD} \cdot V_{CC}^2 \cdot f_{in} + I_{CC} \cdot V_{CC}$ .

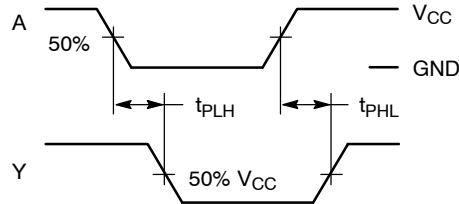

### PROPAGATION DELAYS

$t_R = t_F = 2.5$  ns, 10% to 90%;  $f = 1$  MHz;  $t_W = 500$  ns

Figure 3. Switching Waveforms

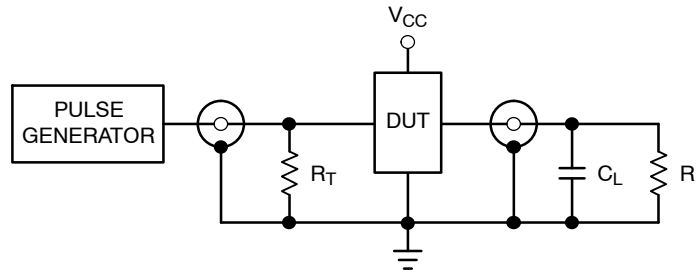

$R_T = Z_{OUT}$  of pulse generator (typically 50 Ω)

Figure 4. Test Circuit

# NLX3G16

## ORDERING INFORMATION

Device	Package	Shipping†
NLX3G16AMX1TCG	ULLGA8, 1.95 x 1.0, 0.5P (Pb-Free)	3000 / Tape & Reel
NLX3G16BMX1TCG	ULLGA8, 1.6 x 1.0, 0.4P (Pb-Free)	3000 / Tape & Reel
NLX3G16CMX1TCG	ULLGA8, 1.45 x 1.0, 0.35P (Pb-Free)	3000 / Tape & Reel
NLX3G16DMUTCG	UDFN8, 1.95 x 1.0, 0.5P (Pb-Free)	3000 / Tape & Reel
NLX3G16EMUTCG	UDFN8, 1.6 x 1.0, 0.4P (Pb-Free)	3000 / Tape & Reel
NLX3G16FMUTCG	UDFN8, 1.45 x 1.0, 0.35P (Pb-Free)	3000 / Tape & Reel

†For information on tape and reel specifications, including part orientation and tape sizes, please refer to our Tape and Reel Packaging Specifications Brochure, BRD8011/D.

# NLX3G16

## PACKAGE DIMENSIONS

UDFN8 1.6x1.0, 0.4P  
CASE 517BY  
ISSUE O

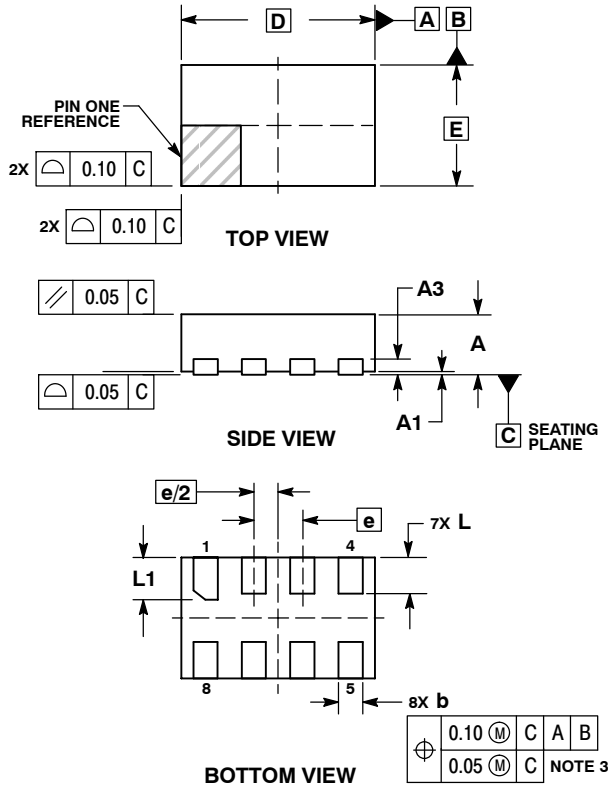

**NOTES:**

1. DIMENSIONING AND TOLERANCING PER ASME Y14.5M, 1994.
2. CONTROLLING DIMENSION: MILLIMETERS.
3. DIMENSION b APPLIES TO PLATED TERMINAL AND IS MEASURED BETWEEN 0.15 AND 0.20 MM FROM TERMINAL TIP.
4. PACKAGE DIMENSIONS EXCLUSIVE OF BURRS AND MOLD FLASH.

DIM	MILLIMETERS	
	MIN	MAX
A	0.45	0.55
A1	0.00	0.05
A3	0.13	REF
b	0.15	0.25
D	1.60	BSC
E	1.00	BSC
e	0.40	BSC
L	0.25	0.35
L1	0.30	0.40

**RECOMMENDED SOLDERING FOOTPRINT\***

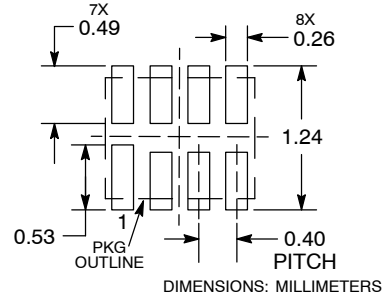

\*For additional information on our Pb-Free strategy and soldering details, please download the ON Semiconductor Soldering and Mounting Techniques Reference Manual, SOLDERRM/D.

# NLX3G16

## PACKAGE DIMENSIONS

UDFN8 1.45x1.0, 0.35P  
CASE 517BZ  
ISSUE O

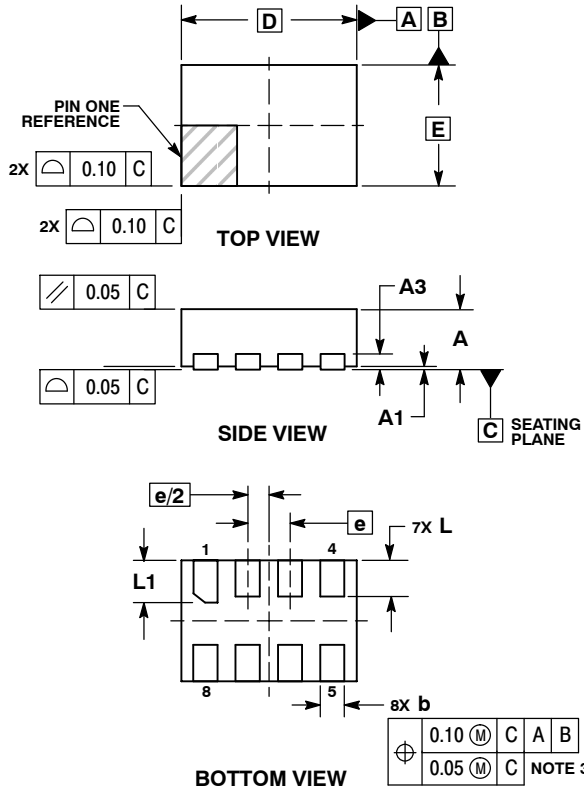

**NOTES:**

1. DIMENSIONING AND TOLERANCING PER ASME Y14.5M, 1994.
2. CONTROLLING DIMENSION: MILLIMETERS.
3. DIMENSION b APPLIES TO PLATED TERMINAL AND IS MEASURED BETWEEN 0.15 AND 0.20 MM FROM TERMINAL TIP.
4. PACKAGE DIMENSIONS EXCLUSIVE OF BURRS AND MOLD FLASH.

DIM	MILLIMETERS	
	MIN	MAX
A	0.45	0.55
A1	0.00	0.05
A3	0.13	REF
b	0.15	0.25
D	1.45	BSC
E	1.00	BSC
e	0.35	BSC
L	0.25	0.35
L1	0.30	0.40

**RECOMMENDED SOLDERING FOOTPRINT\***

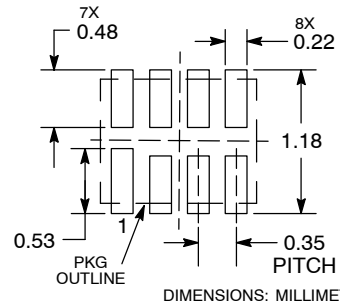

\*For additional information on our Pb-Free strategy and soldering details, please download the ON Semiconductor Soldering and Mounting Techniques Reference Manual, SOLDERRM/D.

# NLX3G16

## PACKAGE DIMENSIONS

UDFN8 1.95x1.0, 0.5P  
CASE 517CA  
ISSUE O

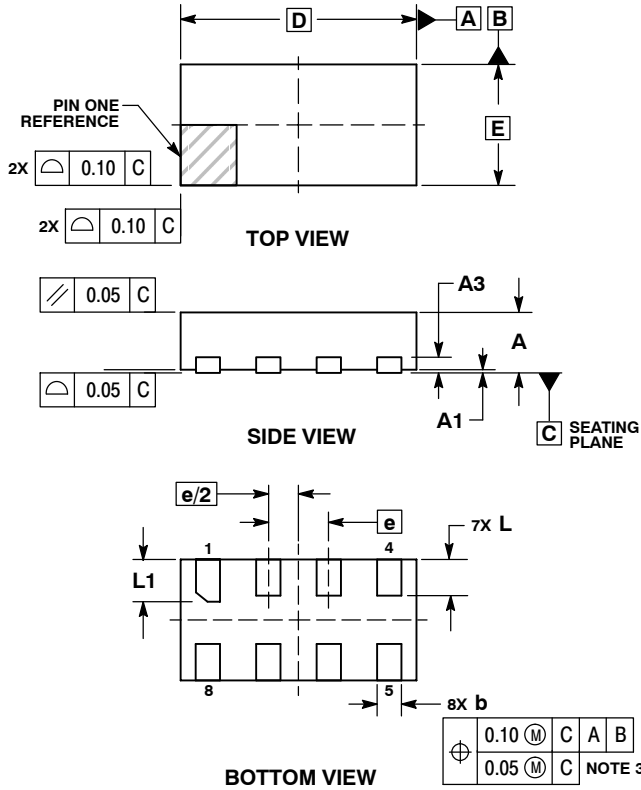

**NOTES:**

1. DIMENSIONING AND TOLERANCING PER ASME Y14.5M, 1994.
2. CONTROLLING DIMENSION: MILLIMETERS.
3. DIMENSION b APPLIES TO PLATED TERMINAL AND IS MEASURED BETWEEN 0.15 AND 0.20 MM FROM TERMINAL TIP.
4. PACKAGE DIMENSIONS EXCLUSIVE OF BURRS AND MOLD FLASH.

MILLIMETERS		
DIM	MIN	MAX
A	0.45	0.55
A1	0.00	0.05
A3	0.13 REF	
b	0.15	0.25
D	1.95 BSC	
E	1.00 BSC	
e	0.50 BSC	
L	0.25	0.35
L1	0.30	0.40

**RECOMMENDED SOLDERING FOOTPRINT\***

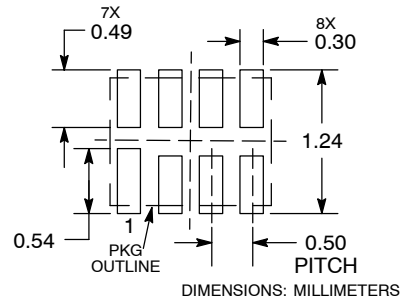

\*For additional information on our Pb-Free strategy and soldering details, please download the ON Semiconductor Soldering and Mounting Techniques Reference Manual, SOLDERRM/D.



# NLX3G16

## PACKAGE DIMENSIONS

ULLGA8 1.45x1.0, 0.35P  
CASE 613AA  
ISSUE A

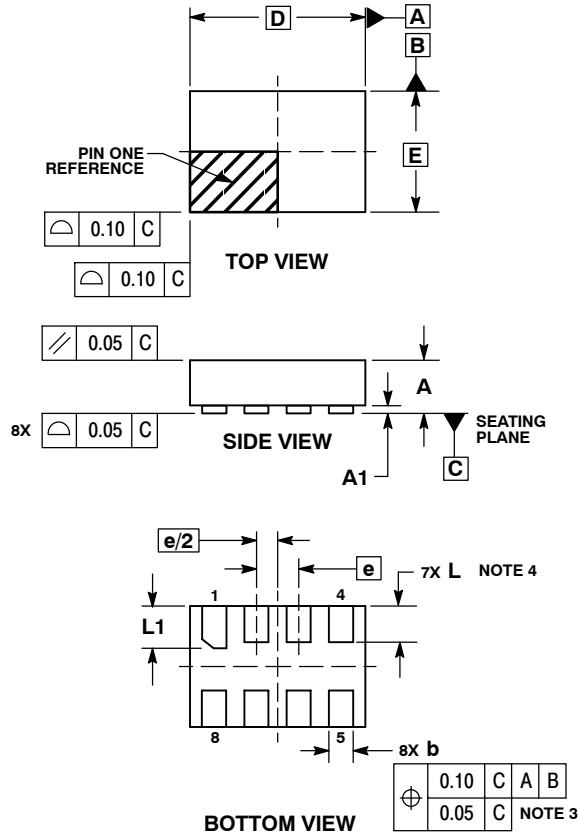

**NOTES:**

1. DIMENSIONING AND TOLERANCING PER ASME Y14.5M, 1994.
2. CONTROLLING DIMENSION: MILLIMETERS.
3. DIMENSION b APPLIES TO PLATED TERMINAL AND IS MEASURED BETWEEN 0.15 AND 0.30 mm FROM THE TERMINAL TIP.
4. A MAXIMUM OF 0.05 PULL BACK OF THE PLATED TERMINAL FROM THE EDGE OF THE PACKAGE IS ALLOWED.

MILLIMETERS		
DIM	MIN	MAX
A	---	0.40
A1	0.00	0.05
b	0.15	0.25
D	1.45 BSC	
E	1.00 BSC	
e	0.35 BSC	
L	0.25	0.35
L1	0.30	0.40

**MOUNTING FOOTPRINT  
SOLDERMASK DEFINED\***

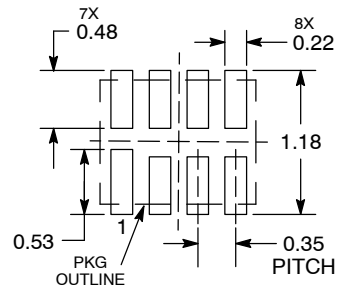

DIMENSIONS: MILLIMETERS

\*For additional information on our Pb-Free strategy and soldering details, please download the ON Semiconductor Soldering and Mounting Techniques Reference Manual, SOLDERRM/D.

# NLX3G16

## PACKAGE DIMENSIONS

ULLGA8 1.6x1.0, 0.4P  
CASE 613AB  
ISSUE A

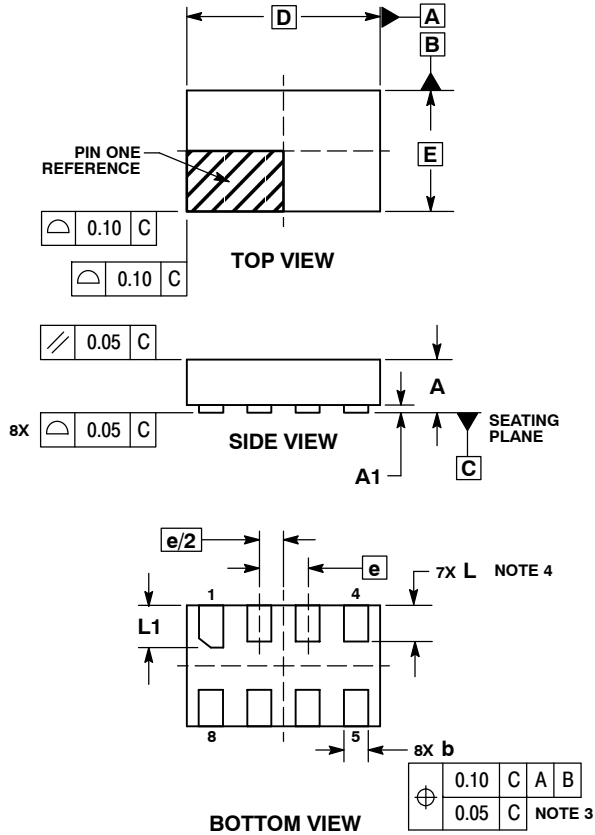

**NOTES:**

1. DIMENSIONING AND TOLERANCING PER ASME Y14.5M, 1994.
2. CONTROLLING DIMENSION: MILLIMETERS.
3. DIMENSION b APPLIES TO PLATED TERMINAL AND IS MEASURED BETWEEN 0.15 AND 0.30 mm FROM THE TERMINAL TIP.
4. A MAXIMUM OF 0.05 PULL BACK OF THE PLATED TERMINAL FROM THE EDGE OF THE PACKAGE IS ALLOWED.

MILLIMETERS		
DIM	MIN	MAX
A	---	0.40
A1	0.00	0.05
b	0.15	0.25
D	1.60	BSC
E	1.00	BSC
e	0.40	BSC
L	0.25	0.35
L1	0.30	0.40

**MOUNTING FOOTPRINT  
SOLDERMASK DEFINED\***

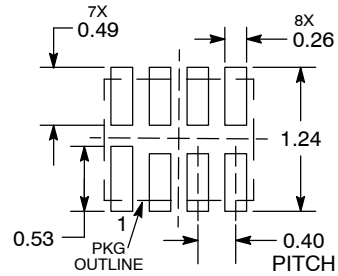

DIMENSIONS: MILLIMETERS

\*For additional information on our Pb-Free strategy and soldering details, please download the ON Semiconductor Soldering and Mounting Techniques Reference Manual, SOLDERRM/D.

# NLX3G16

## PACKAGE DIMENSIONS

ULLGA8 1.95x1.0, 0.5P  
CASE 613AC  
ISSUE A

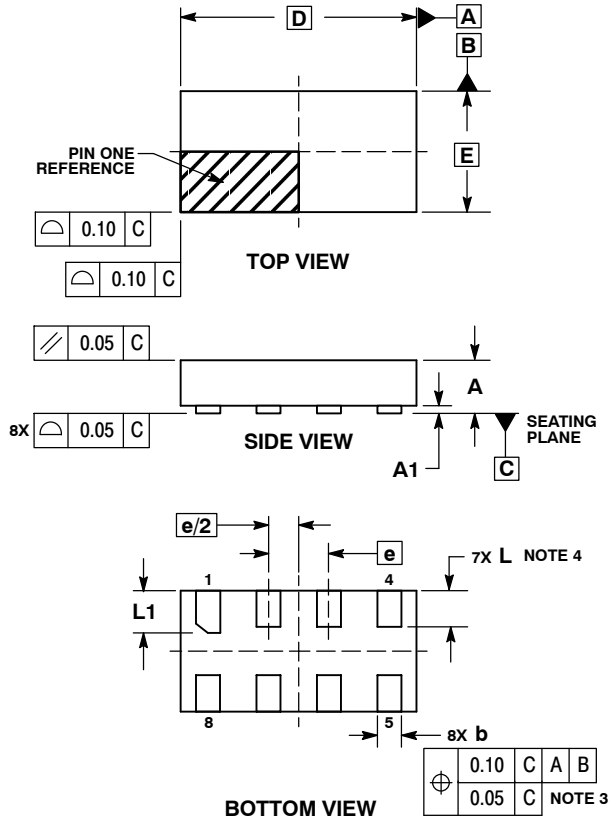

**NOTES:**

1. DIMENSIONING AND TOLERANCING PER ASME Y14.5M, 1994.
2. CONTROLLING DIMENSION: MILLIMETERS.
3. DIMENSION b APPLIES TO PLATED TERMINAL AND IS MEASURED BETWEEN 0.15 AND 0.30 mm FROM THE TERMINAL TIP.
4. A MAXIMUM OF 0.05 PULL BACK OF THE PLATED TERMINAL FROM THE EDGE OF THE PACKAGE IS ALLOWED.

MILLIMETERS		
DIM	MIN	MAX
A	---	0.40
A1	0.00	0.05
b	0.15	0.25
D	1.95 BSC	
E	1.00 BSC	
e	0.50 BSC	
L	0.25	0.35
L1	0.30	0.40

**MOUNTING FOOTPRINT  
SOLDERMASK DEFINED\***

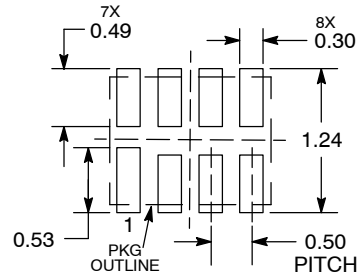

DIMENSIONS: MILLIMETERS

\*For additional information on our Pb-Free strategy and soldering details, please download the ON Semiconductor Soldering and Mounting Techniques Reference Manual, SOLDERRM/D.

MiniGate is a trademark of Semiconductor Components Industries, LLC (SCILLC).

ON Semiconductor and are registered trademarks of Semiconductor Components Industries, LLC (SCILLC). SCILLC reserves the right to make changes without further notice to any products herein. SCILLC makes no warranty, representation or guarantee regarding the suitability of its products for any particular purpose, nor does SCILLC assume any liability arising out of the application or use of any product or circuit, and specifically disclaims any and all liability, including without limitation special, consequential or incidental damages. "Typical" parameters which may be provided in SCILLC data sheets and/or specifications can and do vary in different applications and actual performance may vary over time. All operating parameters, including "Typicals" must be validated for each customer application by customer's technical experts. SCILLC does not convey any license under its patent rights nor the rights of others. SCILLC products are not designed, intended, or authorized for use as components in systems intended for surgical implant into the body, or other applications intended to support or sustain life, or for any other application in which the failure of the SCILLC product could create a situation where personal injury or death may occur. Should Buyer purchase or use SCILLC products for any such unintended or unauthorized application, Buyer shall indemnify and hold SCILLC and its officers, employees, subsidiaries, affiliates, and distributors harmless against all claims, costs, damages, and expenses, and reasonable attorney fees arising out of, directly or indirectly, any claim of personal injury or death associated with such unintended or unauthorized use, even if such claim alleges that SCILLC was negligent regarding the design or manufacture of the part. SCILLC is an Equal Opportunity/Affirmative Action Employer. This literature is subject to all applicable copyright laws and is not for resale in any manner.

**PUBLICATION ORDERING INFORMATION**

**LITERATURE FULFILLMENT:**  
Literature Distribution Center for ON Semiconductor  
P.O. Box 5163, Denver, Colorado 80217 USA  
Phone: 303-675-2175 or 800-344-3860 Toll Free USA/Canada  
Fax: 303-675-2176 or 800-344-3867 Toll Free USA/Canada  
Email: orderlit@onsemi.com

**N. American Technical Support:** 800-282-9855 Toll Free USA/Canada  
**Europe, Middle East and Africa Technical Support:**  
Phone: 421 33 790 2910  
**Japan Customer Focus Center**  
Phone: 81-3-5817-1050

**ON Semiconductor Website:** [www.onsemi.com](http://www.onsemi.com)  
**Order Literature:** <http://www.onsemi.com/orderlit>

For additional information, please contact your local Sales Representative