

DETAILS

Product Number	FCN12076_IRIS-SCREW
Family	Iris
Type	Pack
Color	black
Diameter	38 mm
Height	26,9 mm
Style	round
Optic Material	PMMA
Holder Material	
Fastening	glue, pin, screw
Status	production ready
ROHS Compliant	Yes
Date Updated	9/01/2017



OPTICAL PROPERTIES

LED	Viewing	Light	Effi-		Connector
	Angle	Beam	ciency	cd/lm	
XP-E	4 deg	Real spot	93 %	87.400	-
XP-G	6 deg	Real spot	95 %	-	-
XQ-E	sim: 5	Real spot	sim: 93 %	sim: 80.000-	-
XP-L	8.5 deg	Real spot	93 %	22.200	-
XHP35 HI	7.6 deg	Real spot	90 %	35.900	-
XP-E2	sim: 5,9	Real spot	sim: 94 %	sim: 56.600-	-
LUXEON Rebel	5 deg	Real spot	93 %	75.600	-
LUXEON Rebel ES	7 deg	Real spot	93 %	38.500	-
NCSxx19A	5 deg	Real spot	-	-	-
NVSxx19A	6 deg	Real spot	93 %	38.700	-
NVSW3x9A	8 deg	Real spot	90 %	26.100	-
Oslon SSL 80	4 deg	Real spot	90 %	89.000	-
Oslon SSL 150	4 deg	Real spot	93 %	76.800	-
Z8Y22P	sim: 8	Real spot	sim: 98 %	sim: 29.900-	-

Relative intensity of FCN12076_IRIS-SCREW_(XPH35_HI)

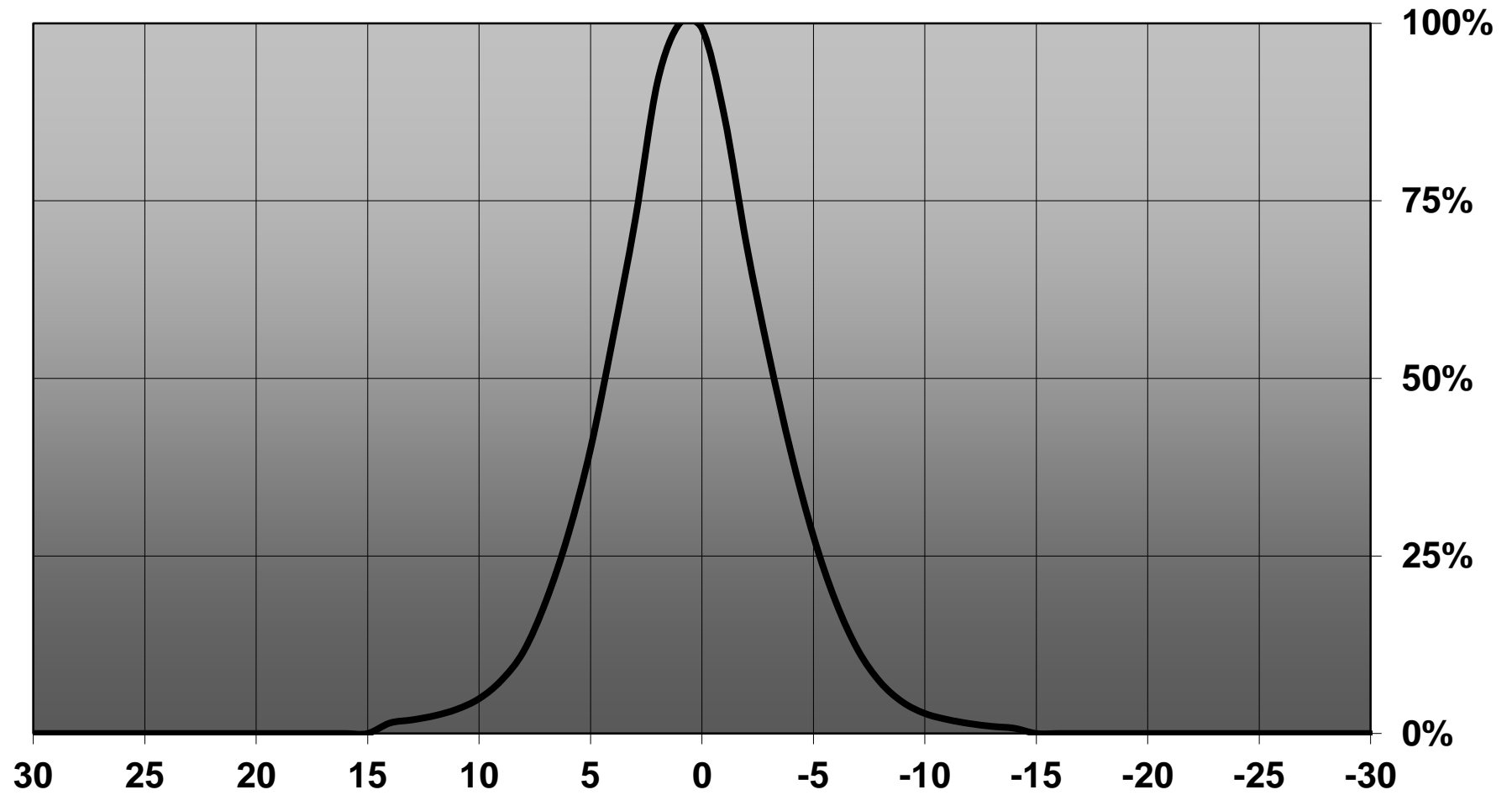

Relative intensity of C4F12077_Iris-RE-tape

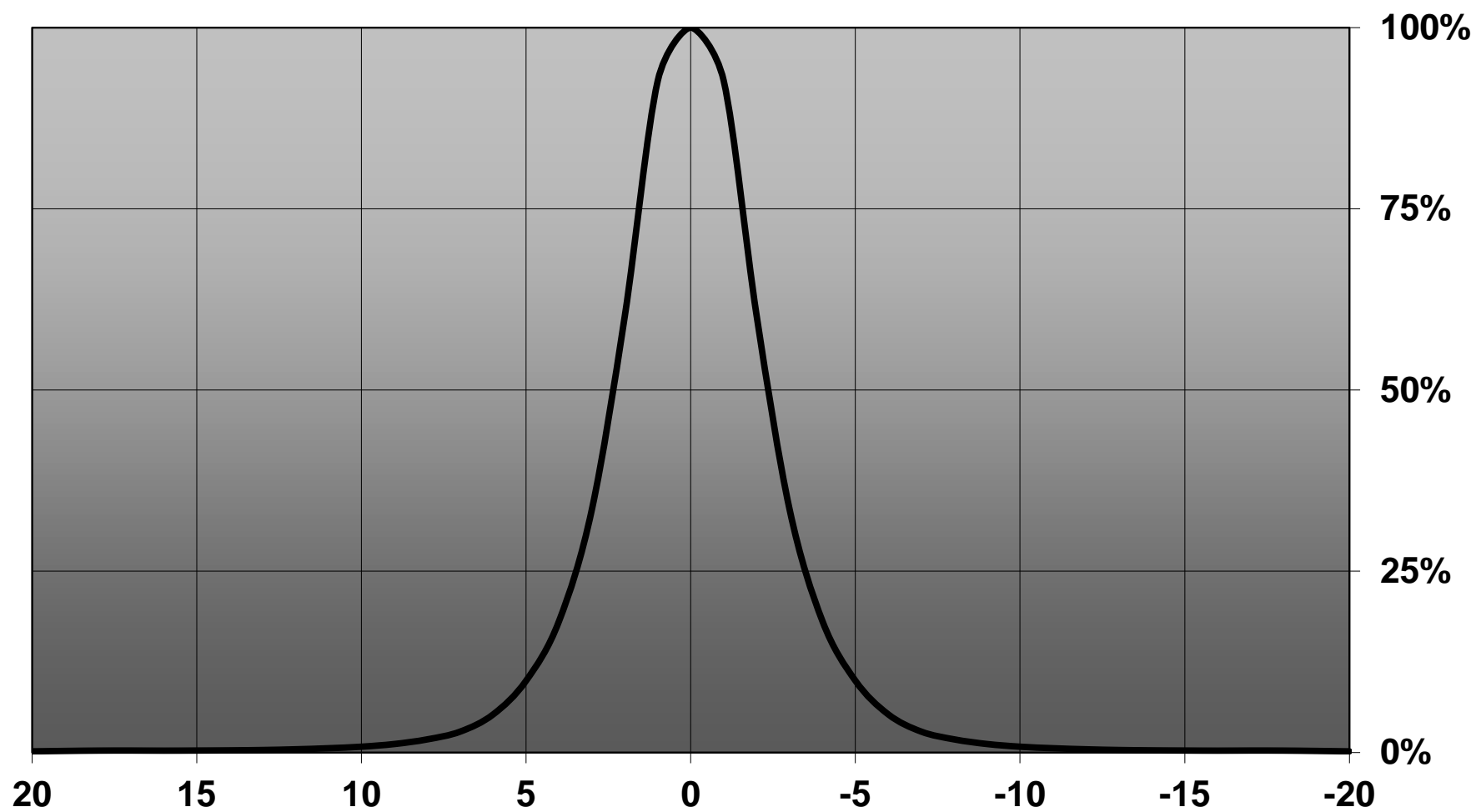

Relative intensity of C4F12077_Iris-RE-ES-tape

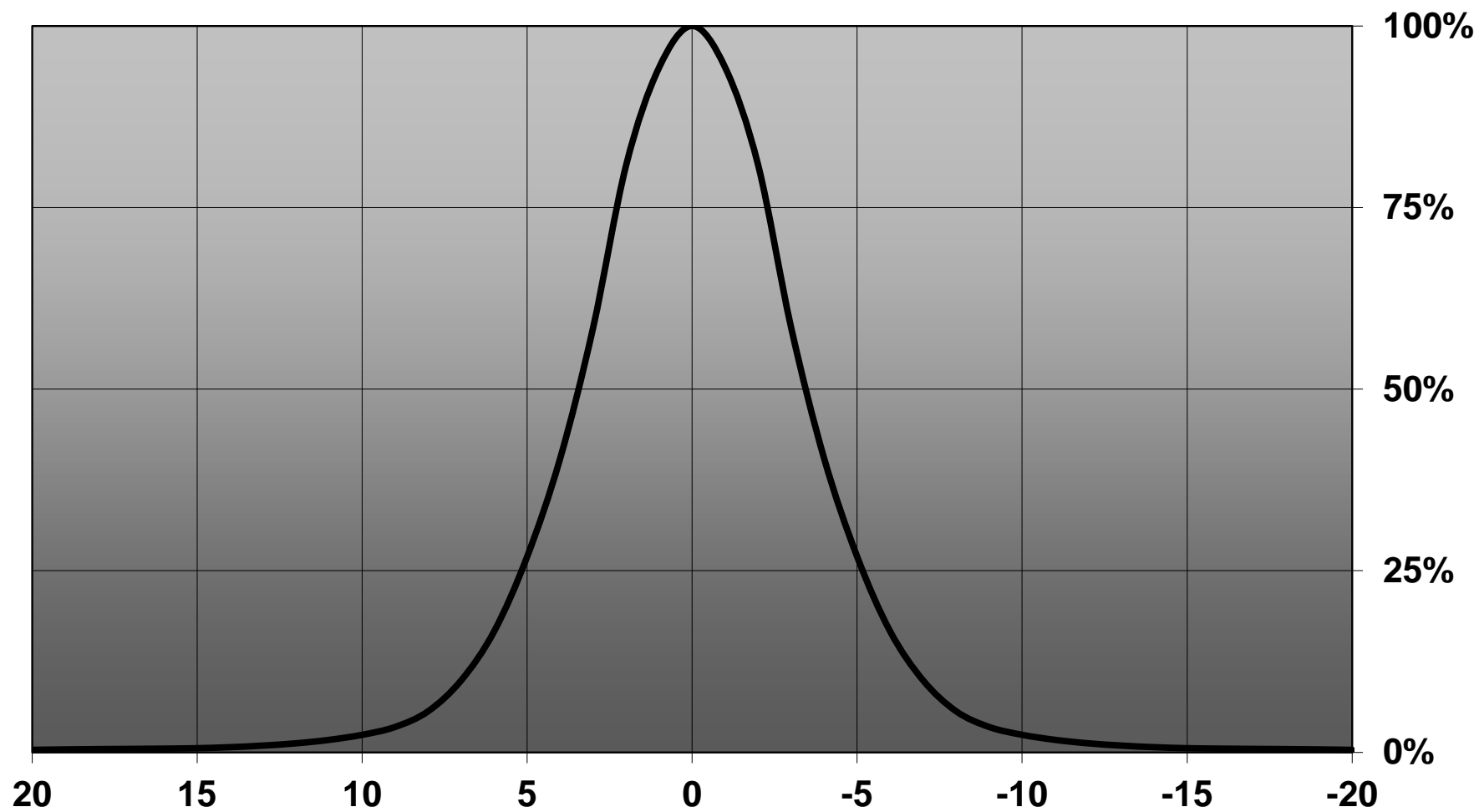

D

C

B

A

4

4

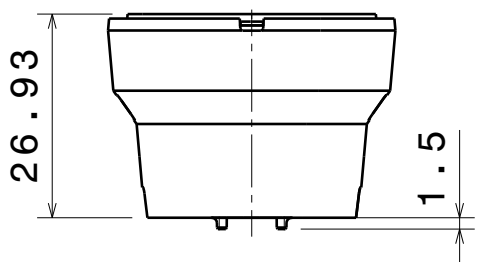

Front view

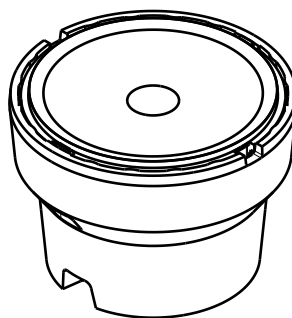
Isometric view
Scale: 1:1

3

3

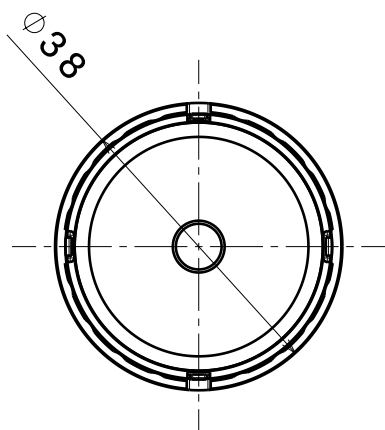

Top view

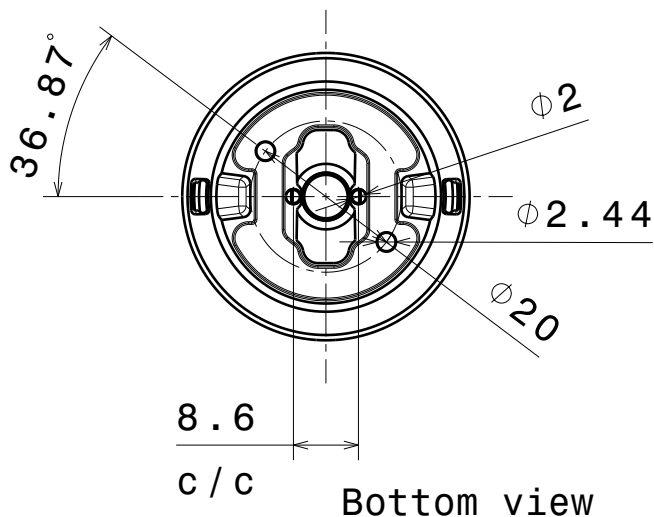

Bottom view

2

2

INDEX	PART NO	DESCRIPTION	MATERIAL	COLOUR
1	F12075	IRIS	PMMA	
2	C12202	IRIS-XP-HLD	PC	black

Tolerances if not otherwise shown
According to DIN ISO 2768-1
Linear measures:
Up to 30mm class M, otherwise class C.
According to DIN ISO 2768-2
Form and position: class L

LEDiL

Ledil Oy
Salorankatu 10
FIN 24240 SALO
Finland

THIRD ANGLE PROJECTION:

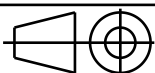

DRAWING TITLE

FCN12076_IRIS-SCREW

This drawing is the property
of LEDiL Oy. It may not be
reproduced, copied or
communicated without a written
agreement with LEDiL Oy.

SIZE PART NUMBER

A4

FCN12076

SCALE	1:1	WEIGHT	19,2 g	SHEET	1/1
-------	-----	--------	--------	-------	-----

1

1

D

A

Luminaire: Ledil Oy C4F12077_Iris-XP-tape C4F12077_Iris-XP-tape LOR=95%
Lamps: 1 x Cree XP-E (white)

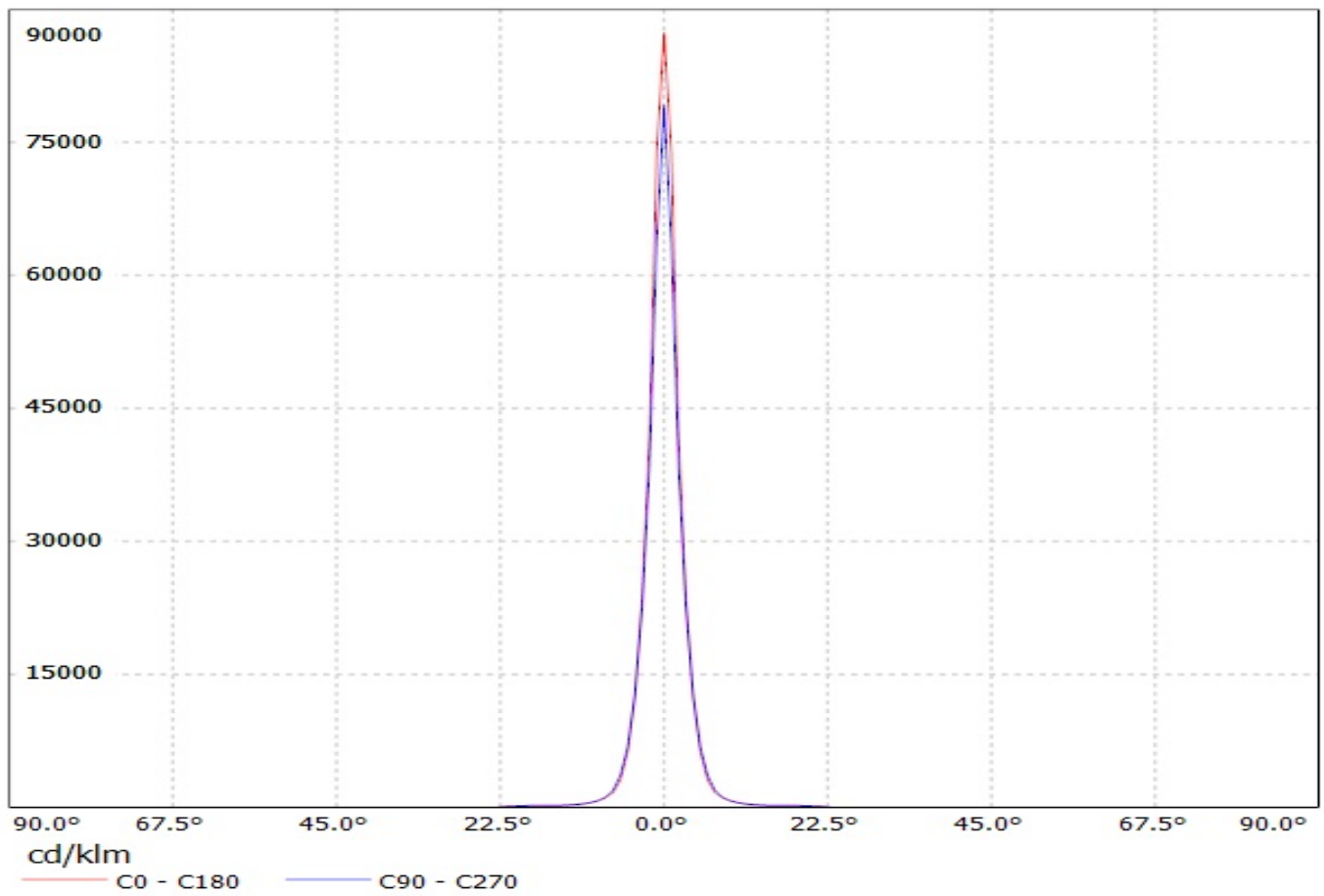

Luminaire: Ledil Oy Iris-XP-G Iris-XP-G
Lamps: 1 x Cree XP-G (White)

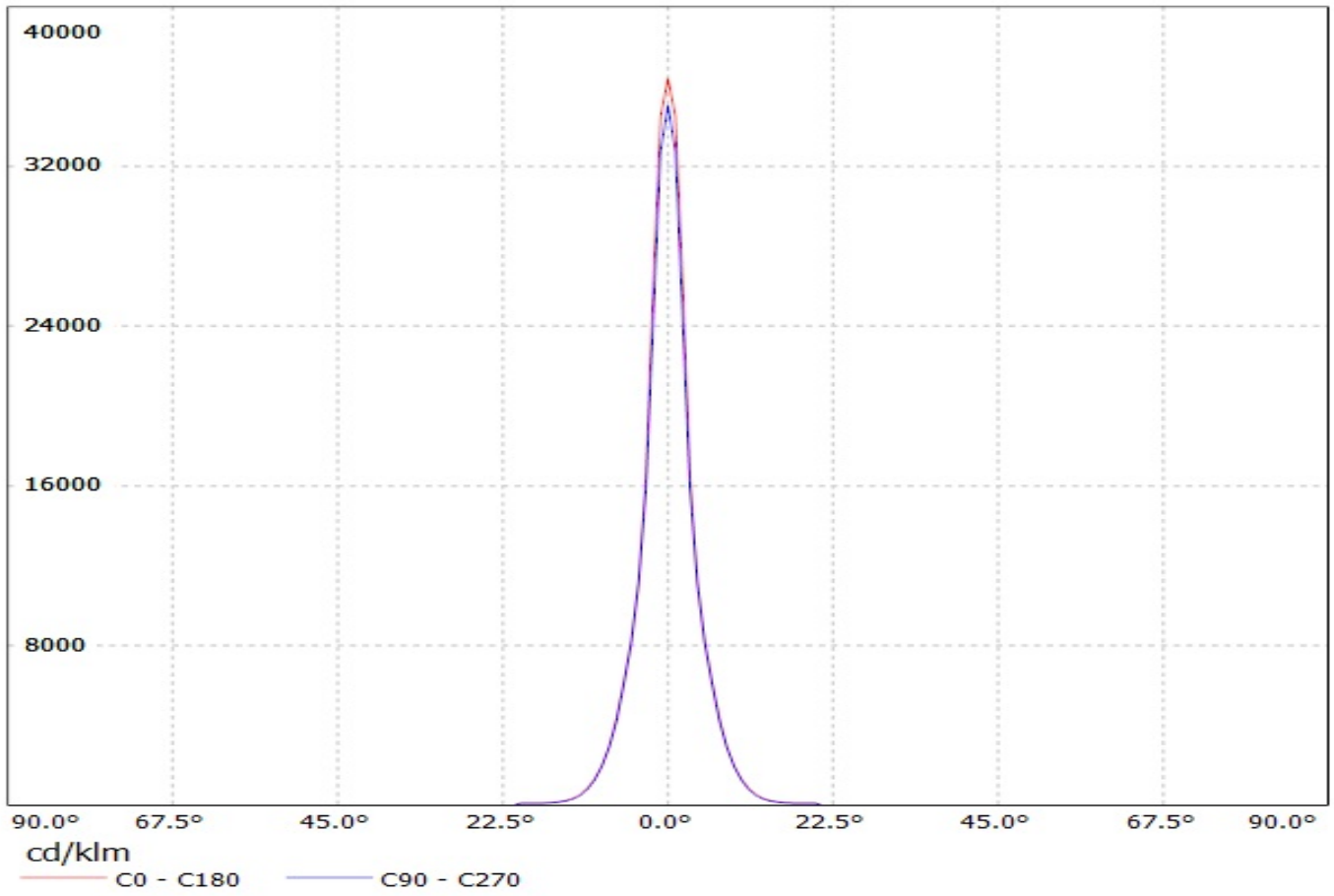

Luminaire: LEDiL Oy FCN12076_IRIS-SCREW_(XP-L)
Lamps: 1 x Cree_XP-L_124.988lm@250mA_P=0.739258W_I=249.8mA

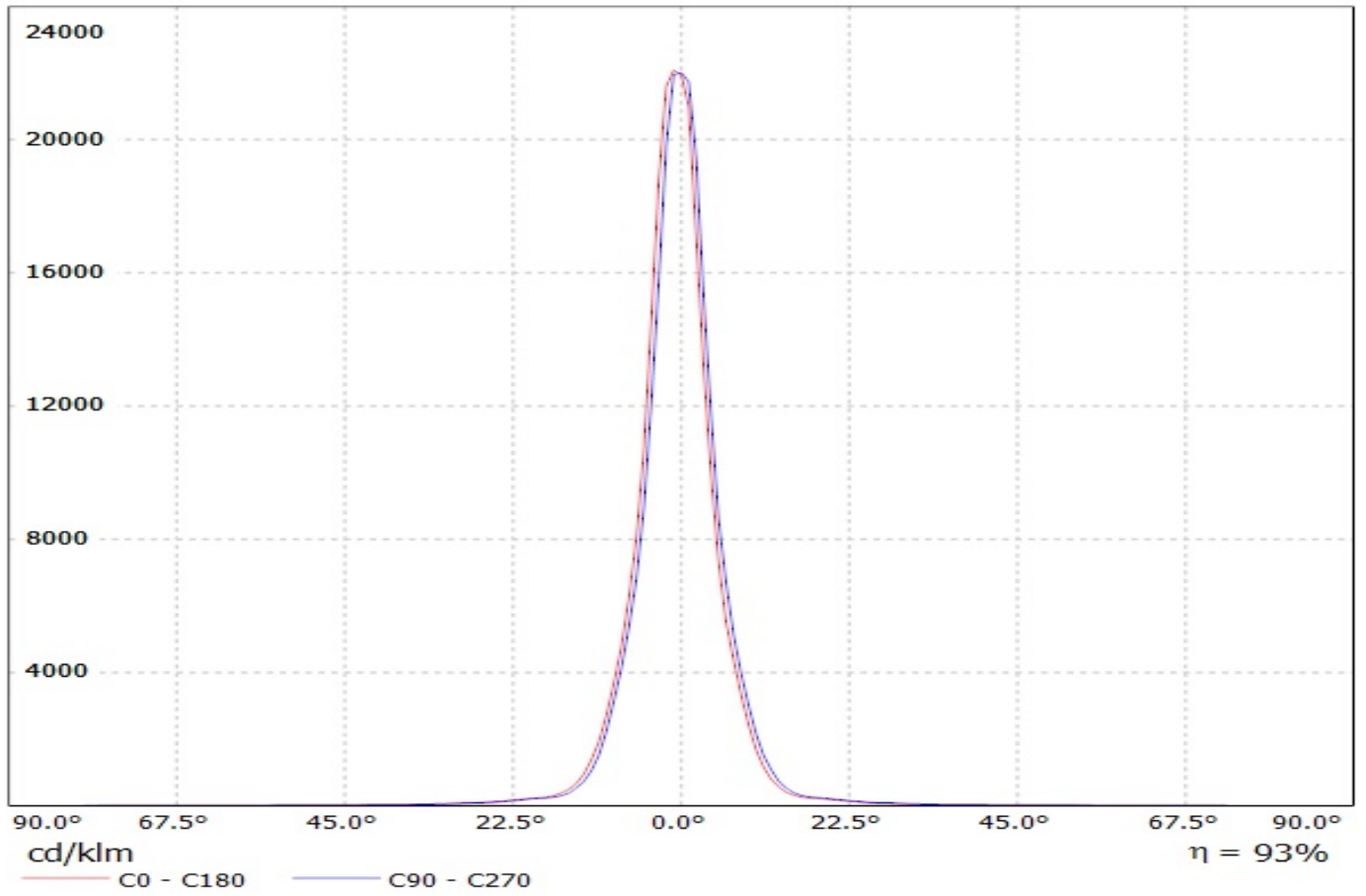

Luminaire: Ledil Oy FCN12076_IRIS-SCREW_(XP-E2)_SIMULATED
Lamps: 1 x Cree XP-E2

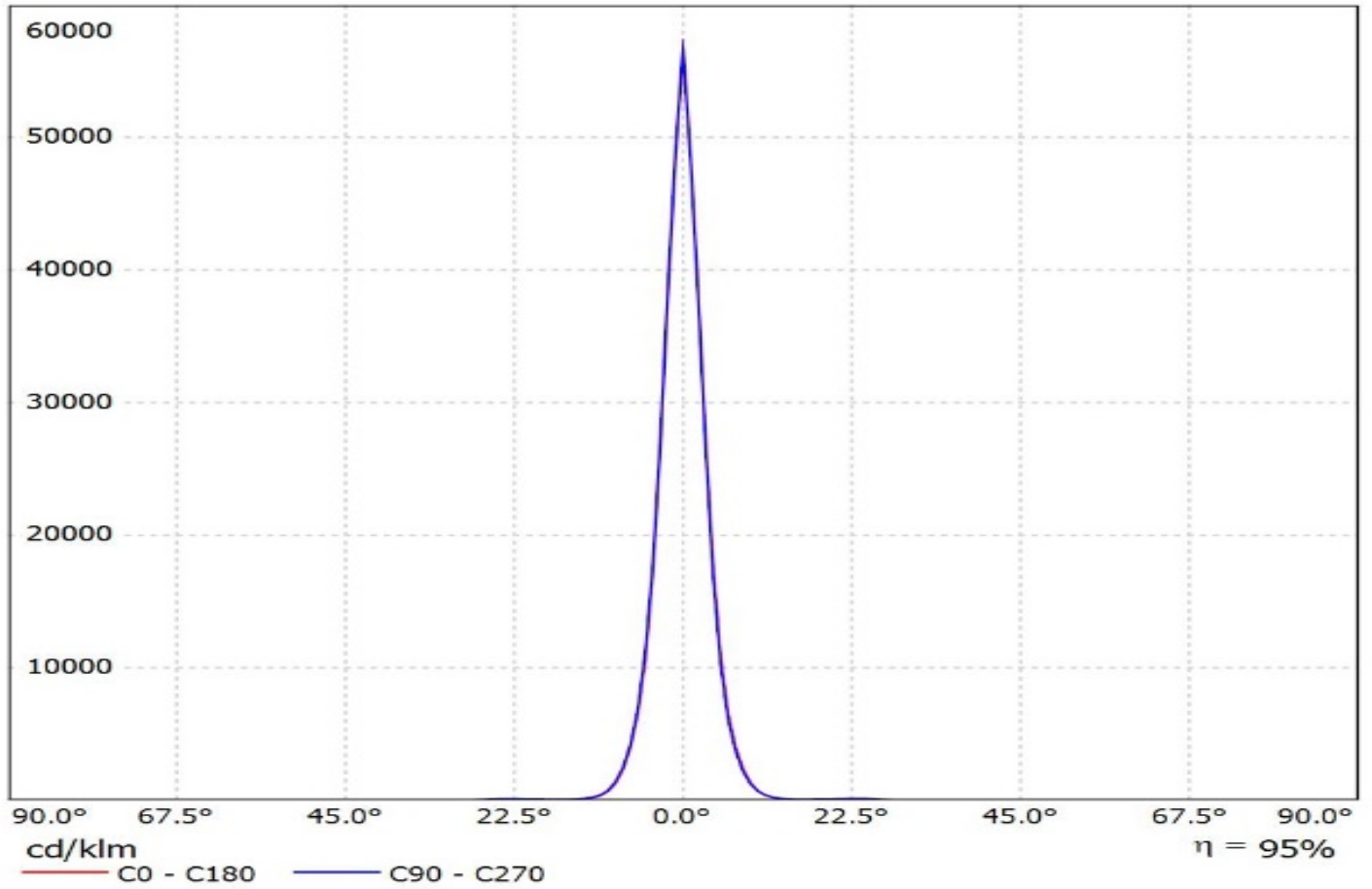

Luminaire: Ledil Oy FCX12077_IRIS (Luxeon Rebel) LOR=93%
Lamps: 1 x Luxeon Rebel 84lm @ 250mA

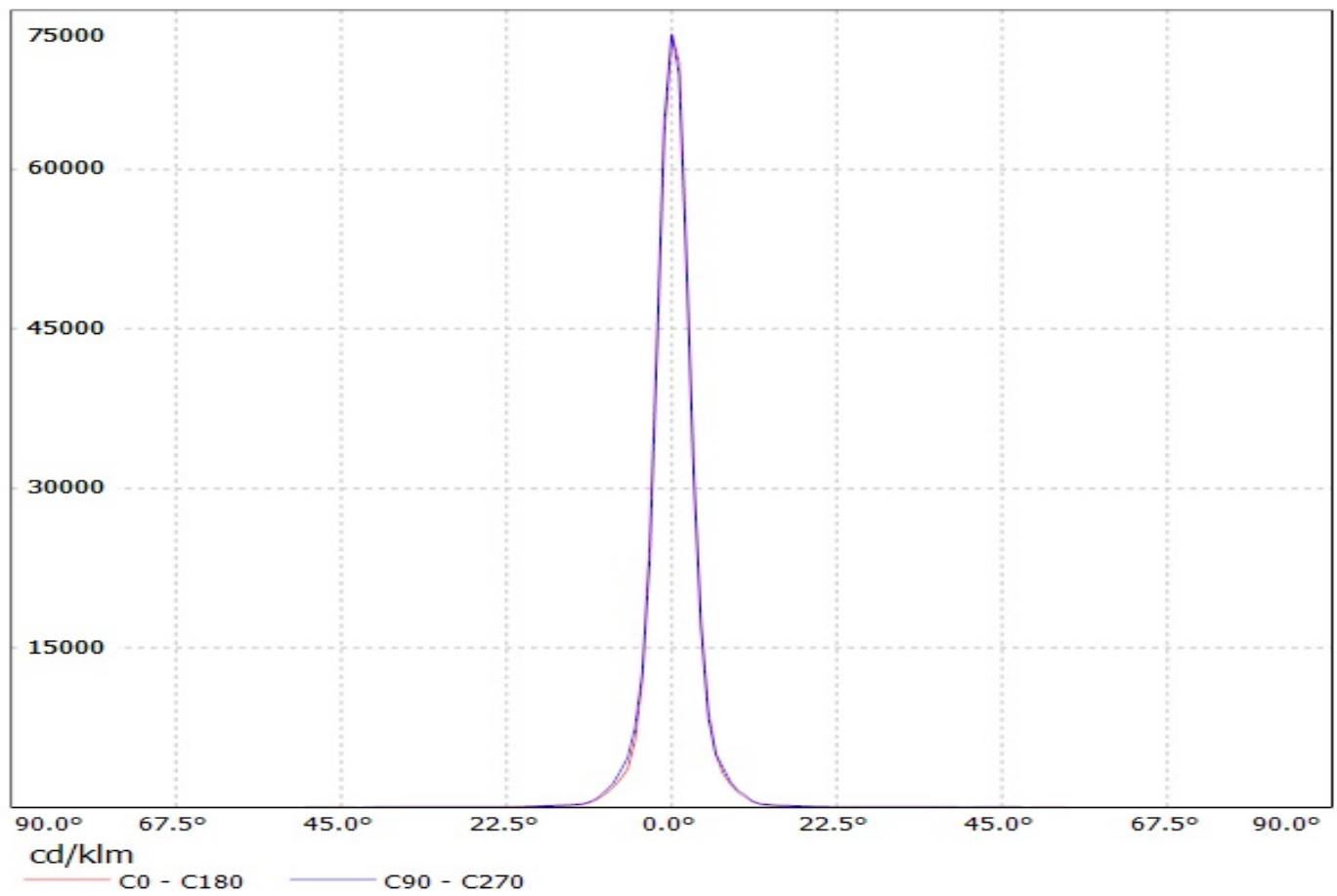

Luminaire: Ledil Oy FCX12077_IRIS-RE-ES LOR=93%
Lamps: 1 x Luxeon Rebel-ES 250mA 92lm

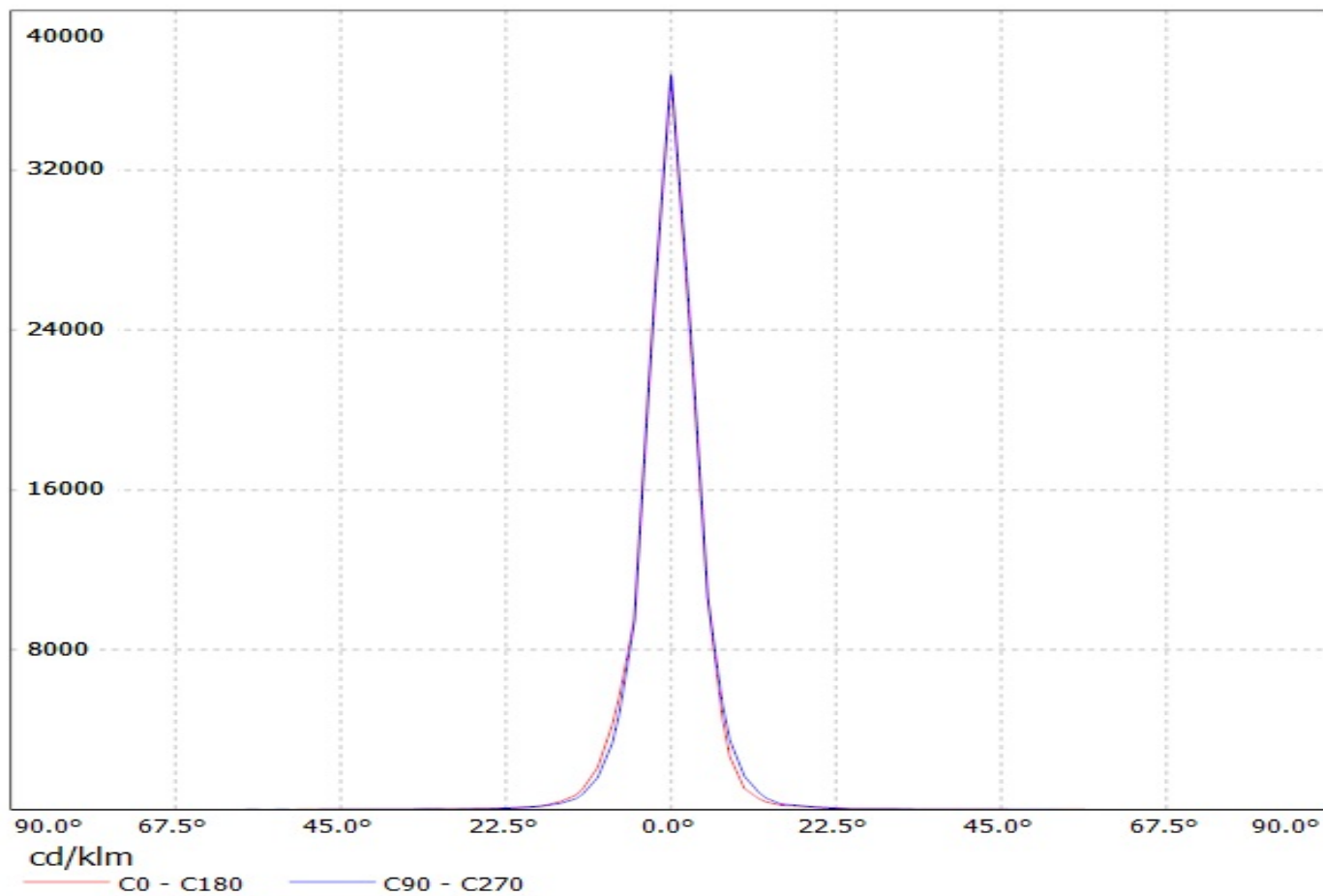

Luminaire: Ledil Oy C4F12077_Iris-NCS19-tape C4F12077_Iris-NCS19-tape
Lamps: 1 x Nichia NCS19 89lm @ 250m

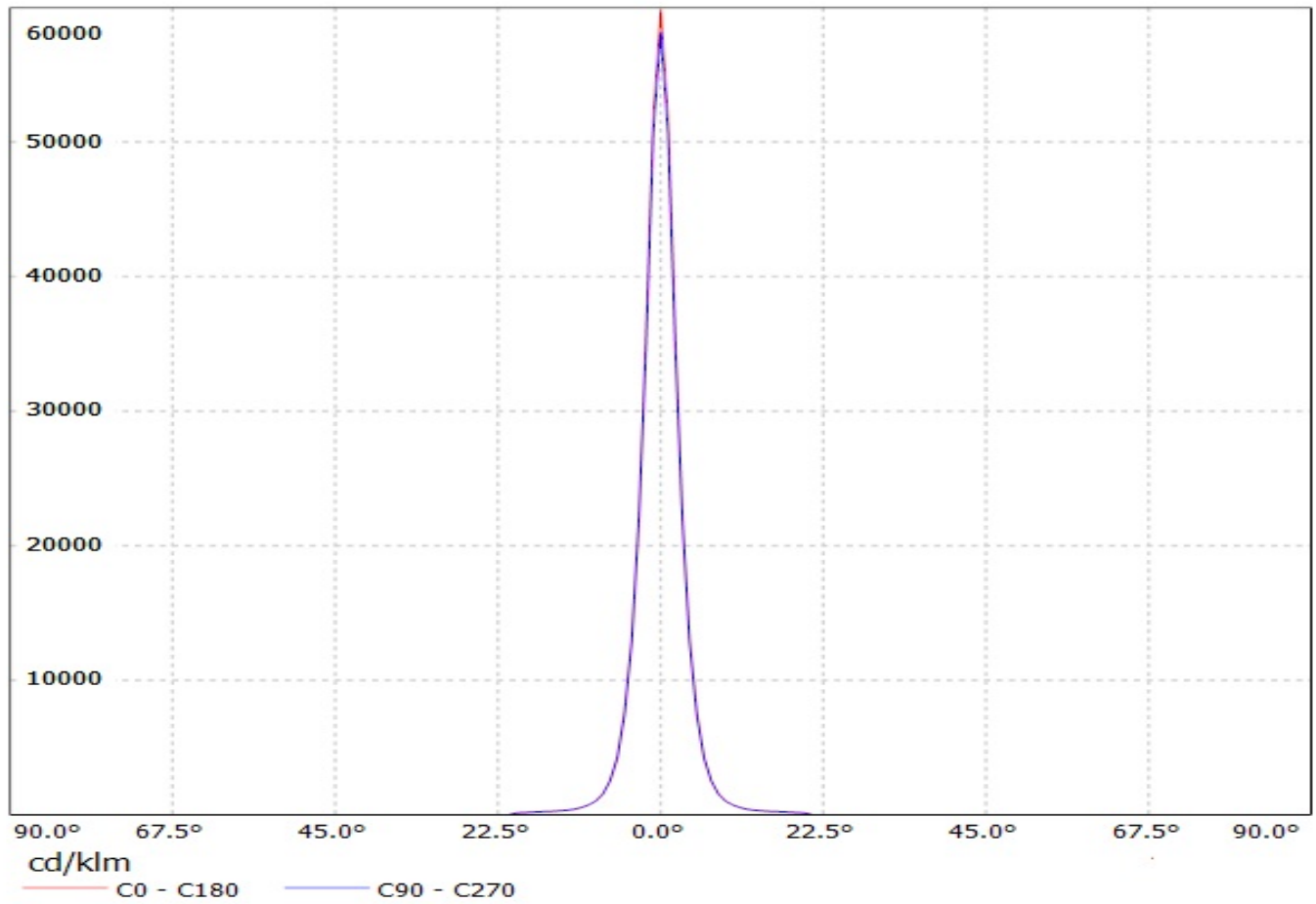

Luminaire: Ledil Oy C4F12077_Iris-NVS19-tape C4F12077_Iris-NVS19-tape
Lamps: 1 x Nichia NVS19 98,8lm @ 25

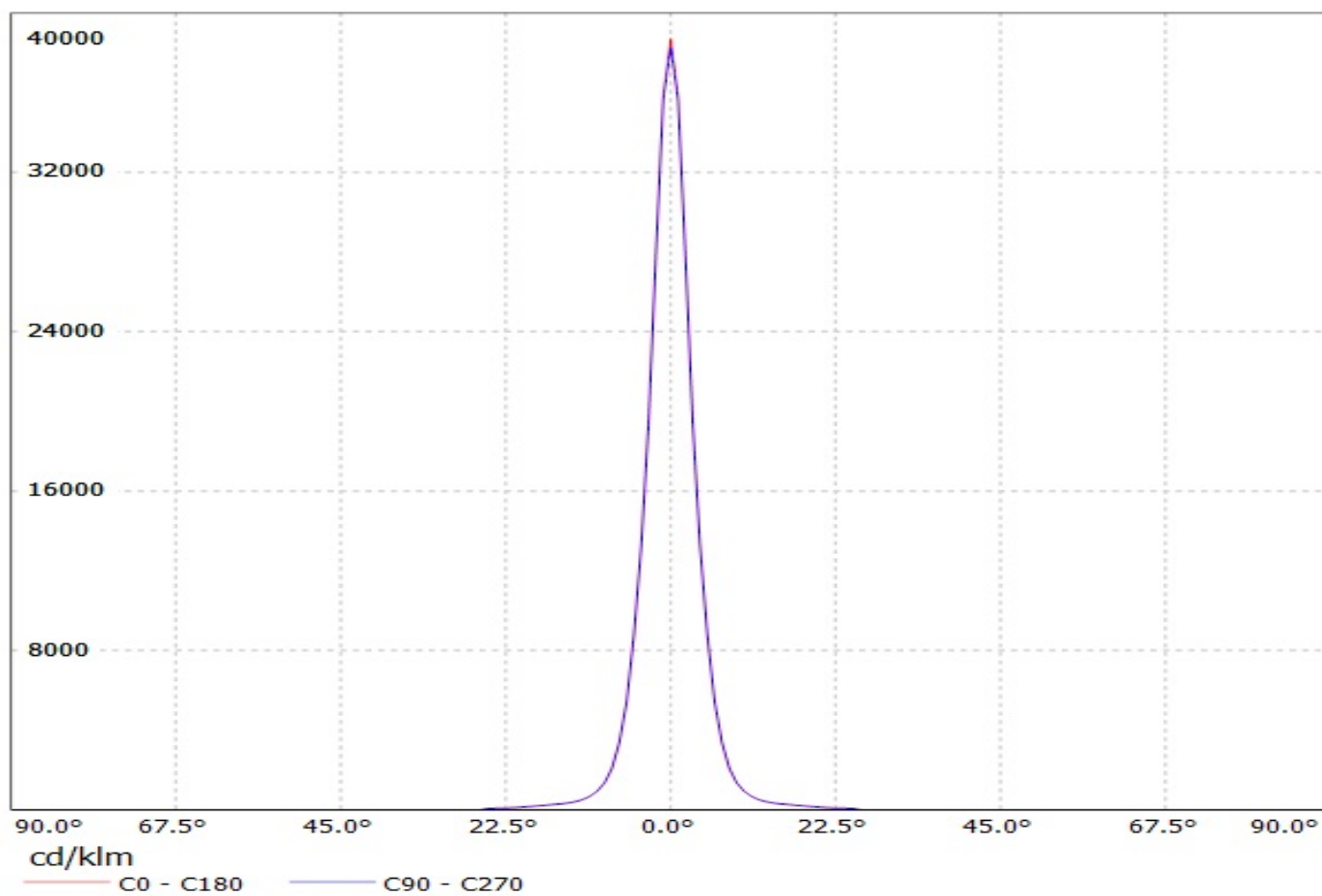

Luminaire: Ledil FCN12076_IRIS-SCREW_(NVSW319AE)

Lamps: 1 x Nichia_NVSW319AE_126.092lm@250mA_P=0.73005W_I=0.25A

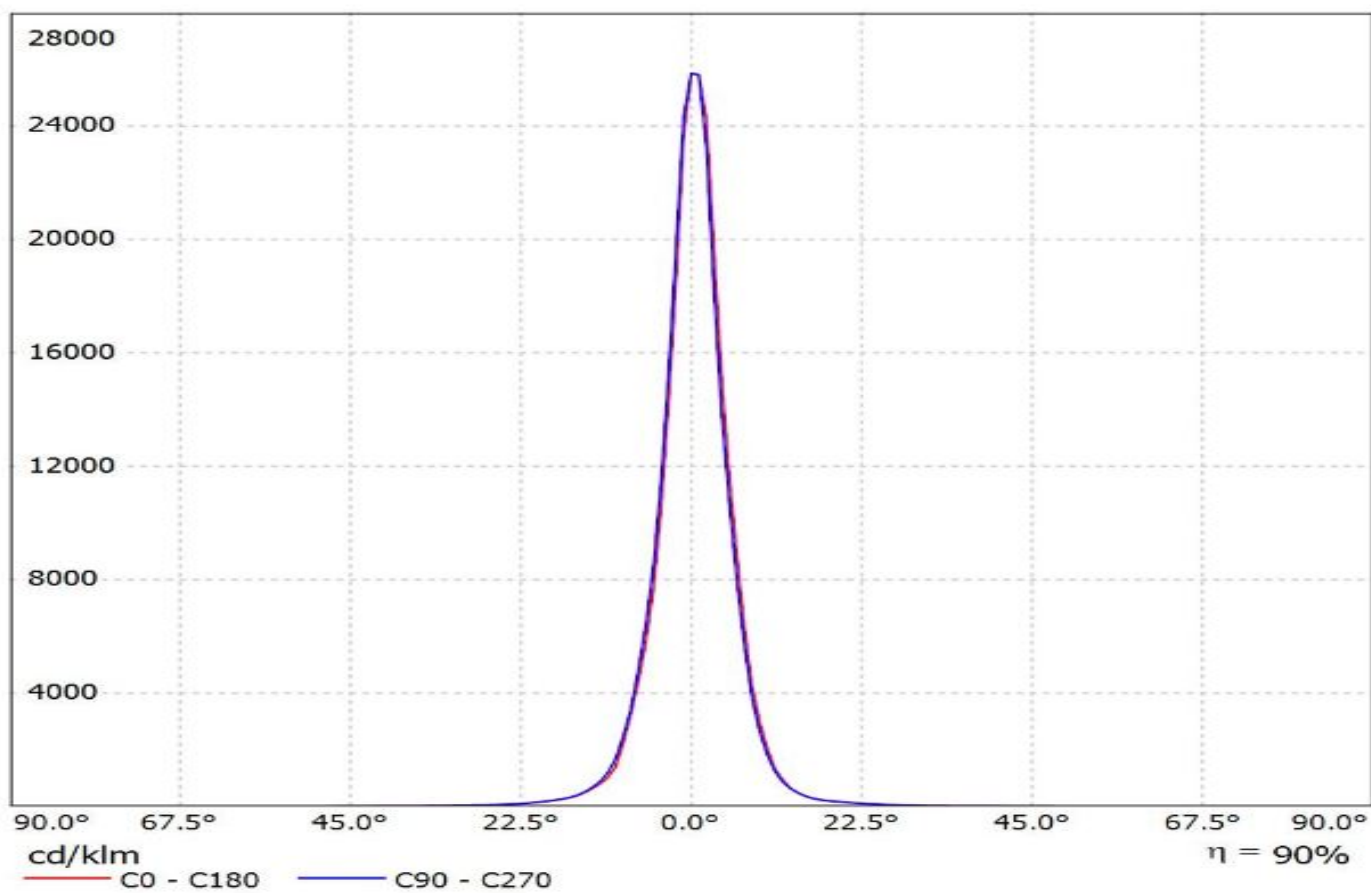

Luminaire: Ledil Oy C4F12077_Iris-OSL150 C4F12077_Iris-OSL150
Lamps: 1 x Osram Oslon 150 deg 72lm

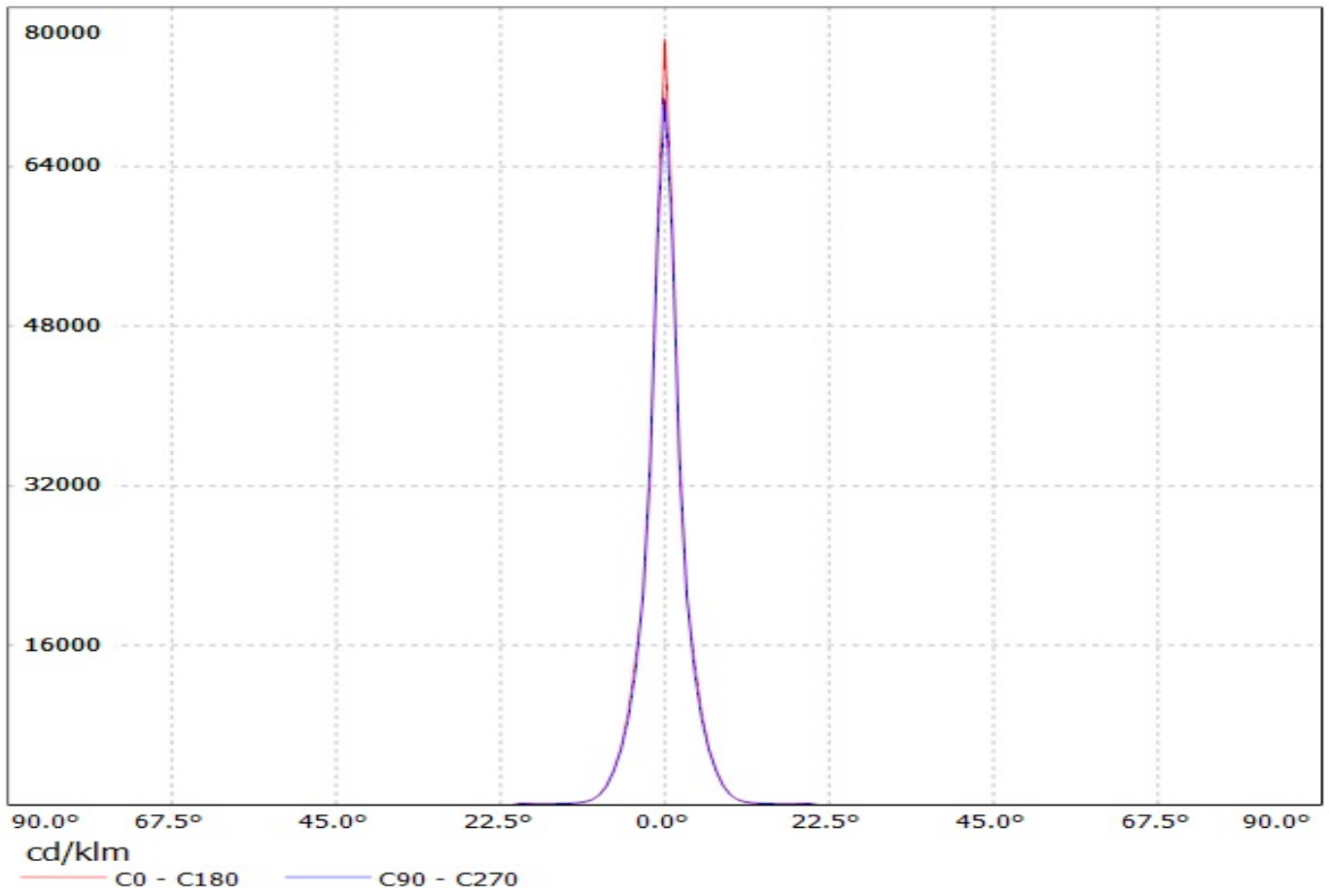

Luminaire: Ledil Oy CAF12077_Iris-XP-tape CAF12077_Iris-XP-tape LOR=95%
Lamps: 1 x Cree XP-E (white)

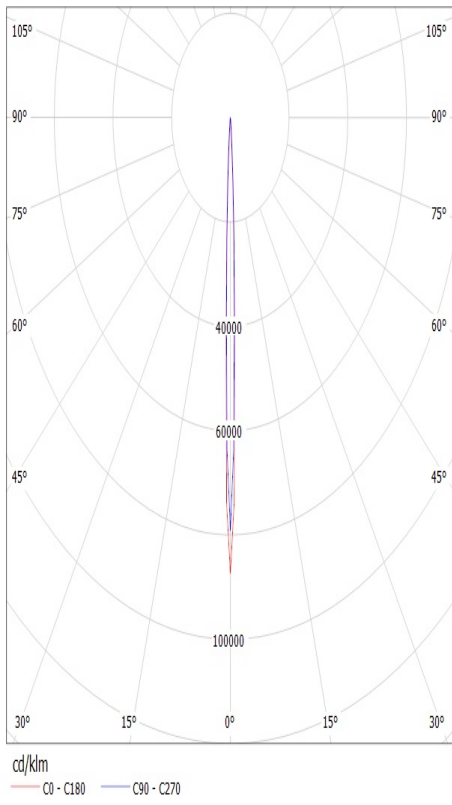

Luminaire: Ledil Oy Iris-XP-G Iris-XP-G
Lamps: 1 x Cree XP-G (White)

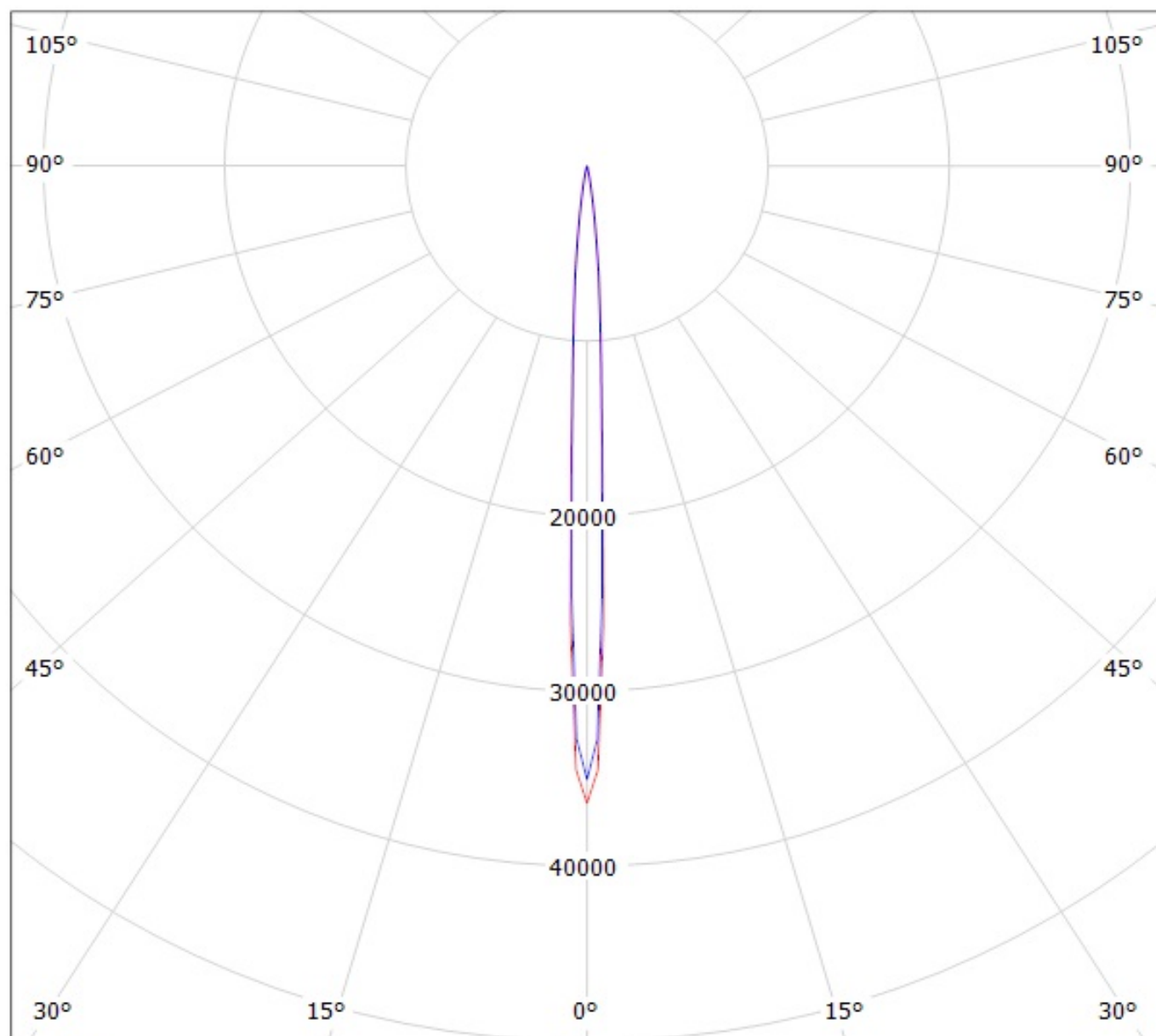

cd/klm

— C0 - C180

— C90 - C270

Luminaire: LEDiL Oy FCN12076_IRIS-SCREW_(XP-L)
Lamps: 1 x Cree_XP-L_124.988lm@250mA_P=0.739258W_I=249.8mA

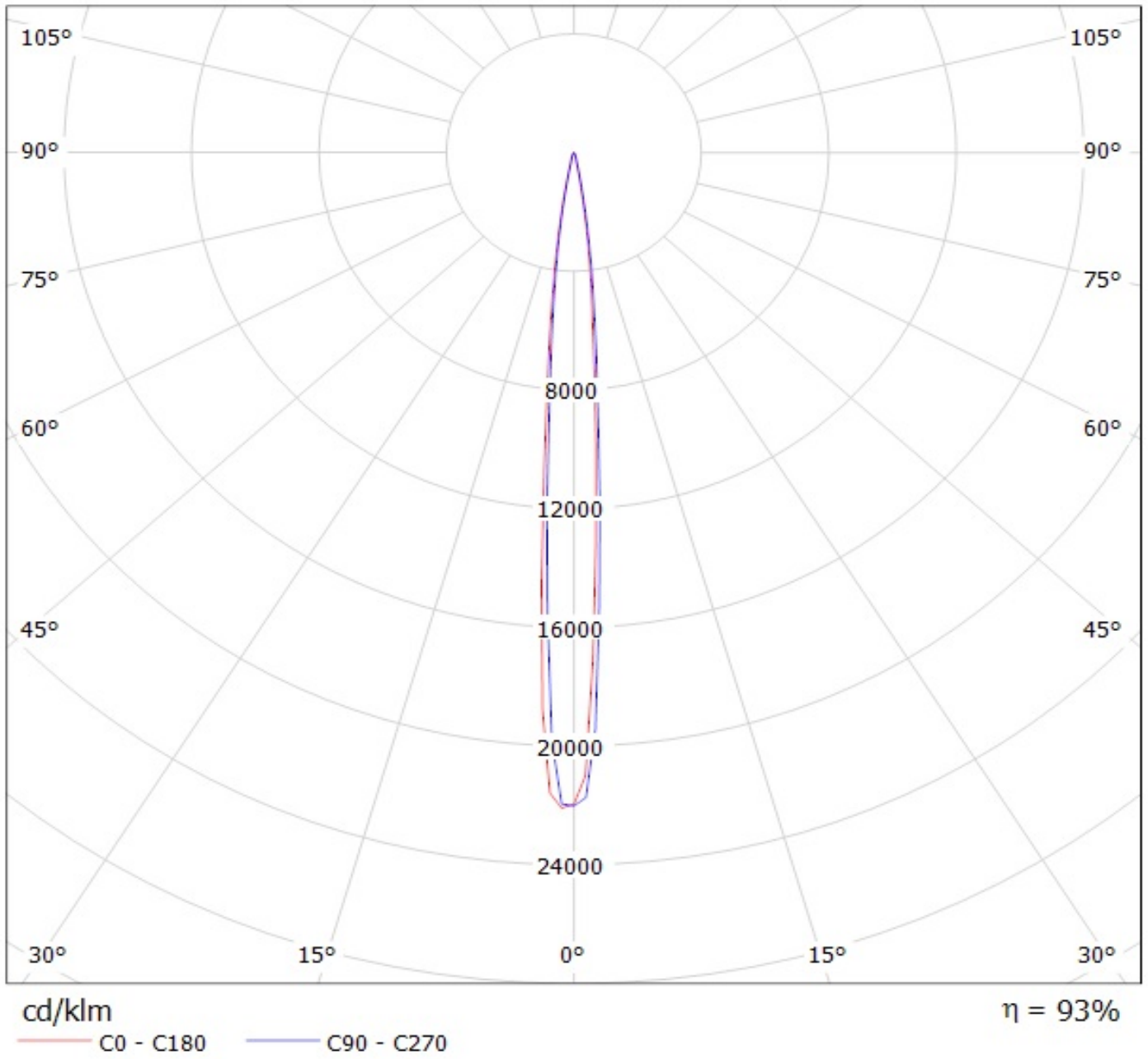

Luminaire: Ledil Oy FCN12076_IRIS-SCREW_(XP-E2)_SIMULATED

Lamps: 1 x Cree XP-E2

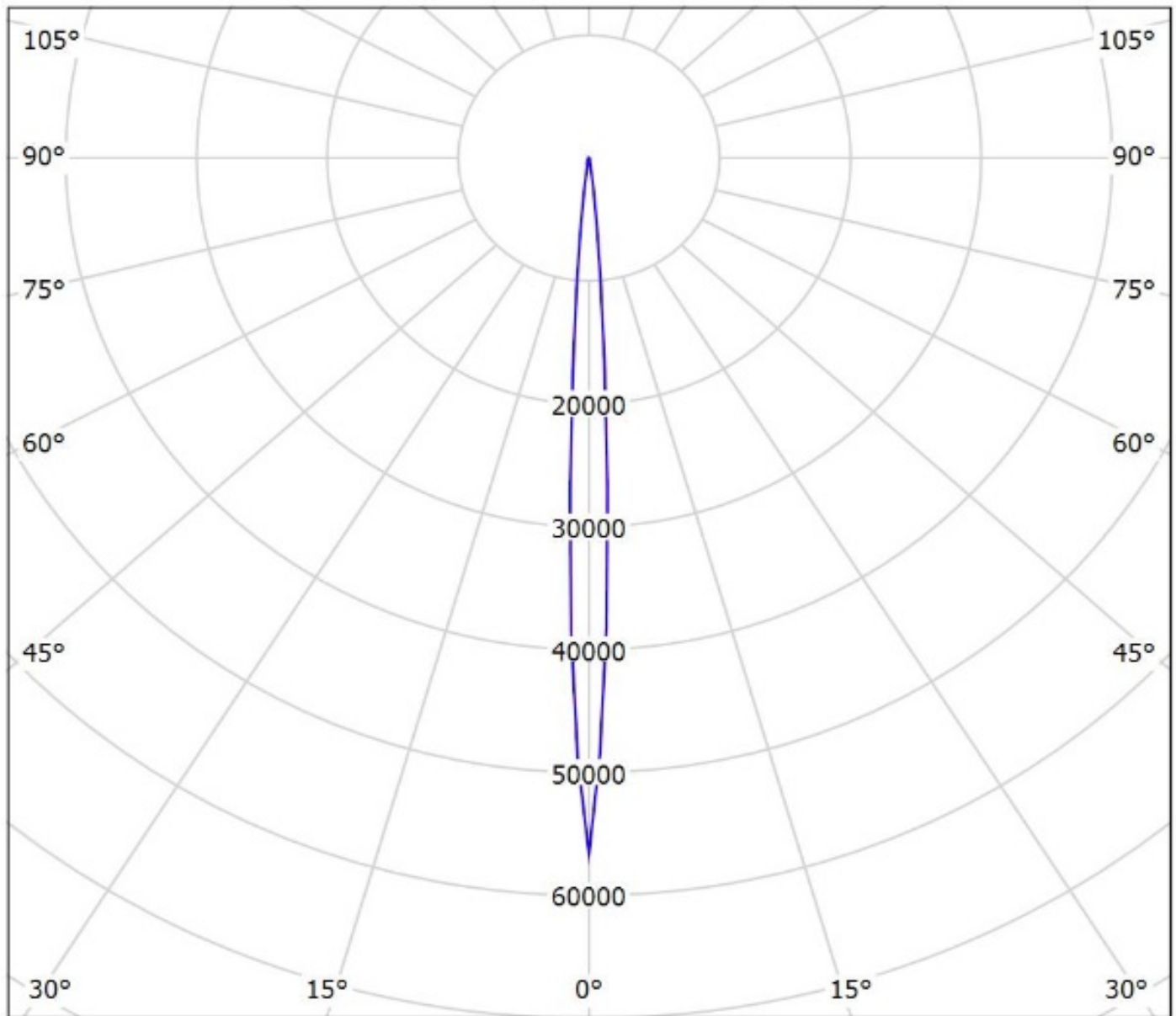

cd/klm

— C0 - C180

— C90 - C270

$\eta = 95\%$

Luminaire: Ledil Oy FCX12077_IRIS (Luxeon Rebel) LOR=93%
Lamps: 1 x Luxeon Rebel 84lm @ 250mA

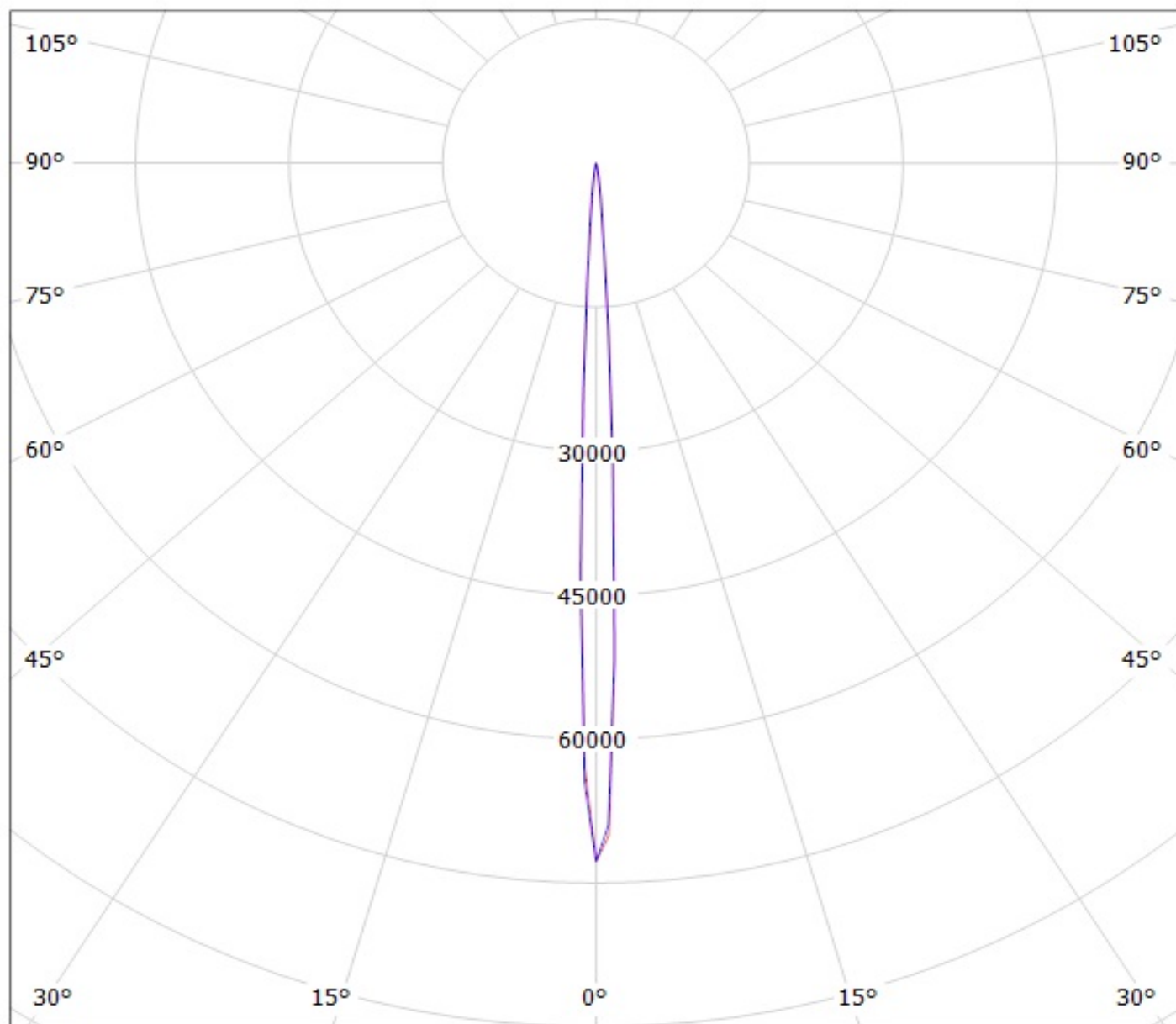

cd/klm

— C0 - C180

— C90 - C270

Luminaire: Ledil Oy FCX12077_IRIS-RE-ES LOR=93%
Lamps: 1 x Luxeon Rebel-ES 250mA 92lm

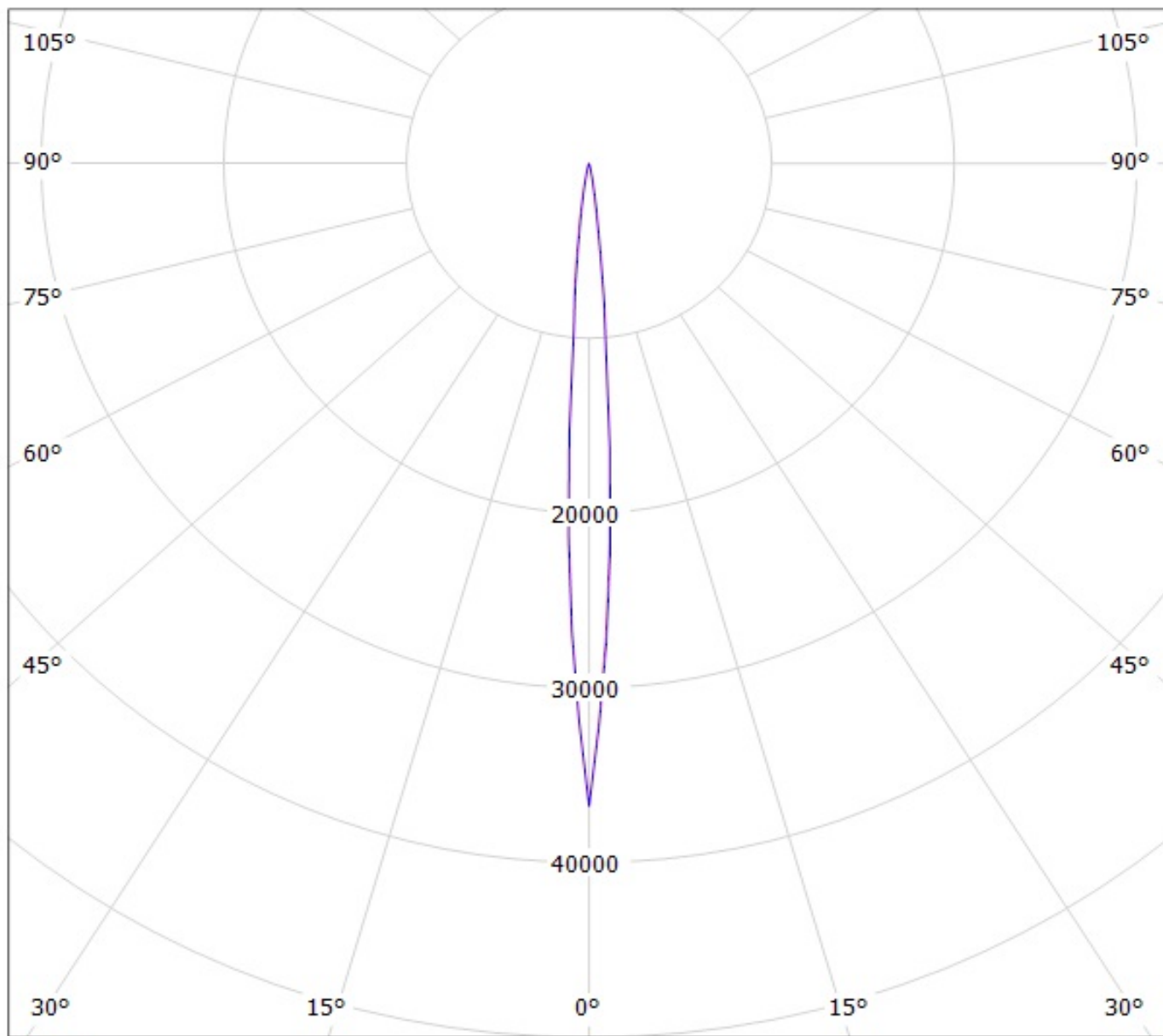

cd/klm

— C0 - C180

— C90 - C270

Luminaire: Ledil Oy C4F12077_Iris-NCS19-tape C4F12077_Iris-NCS19-tape
Lamps: 1 x Nichia NCS19 89lm @ 250m

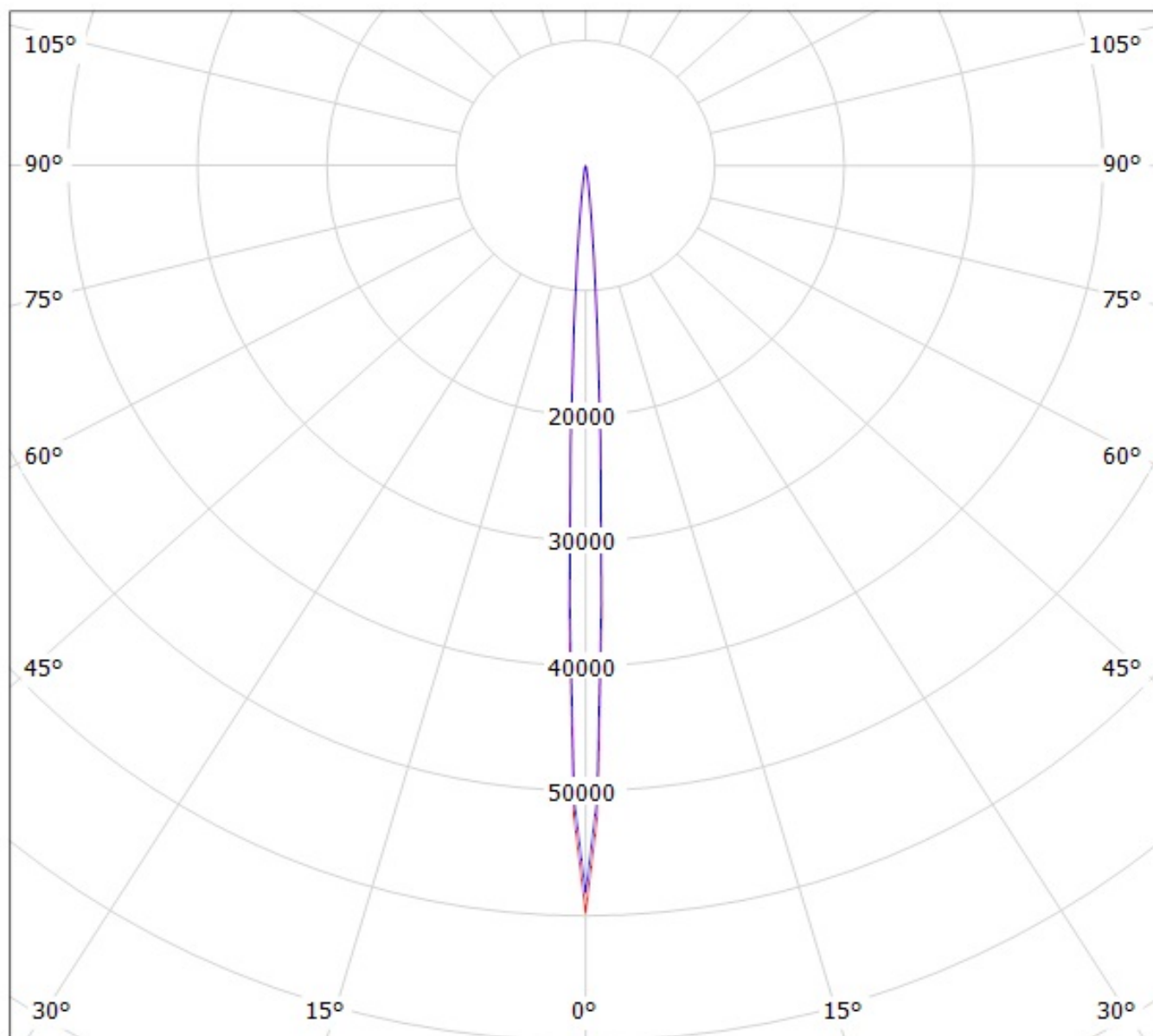

cd/klm

— C0 - C180

— C90 - C270

Luminaire: Ledil Oy C4F12077_Iris-NVS19-tape C4F12077_Iris-NVS19-tape
Lamps: 1 x Nichia NVS19 98,8lm @ 25

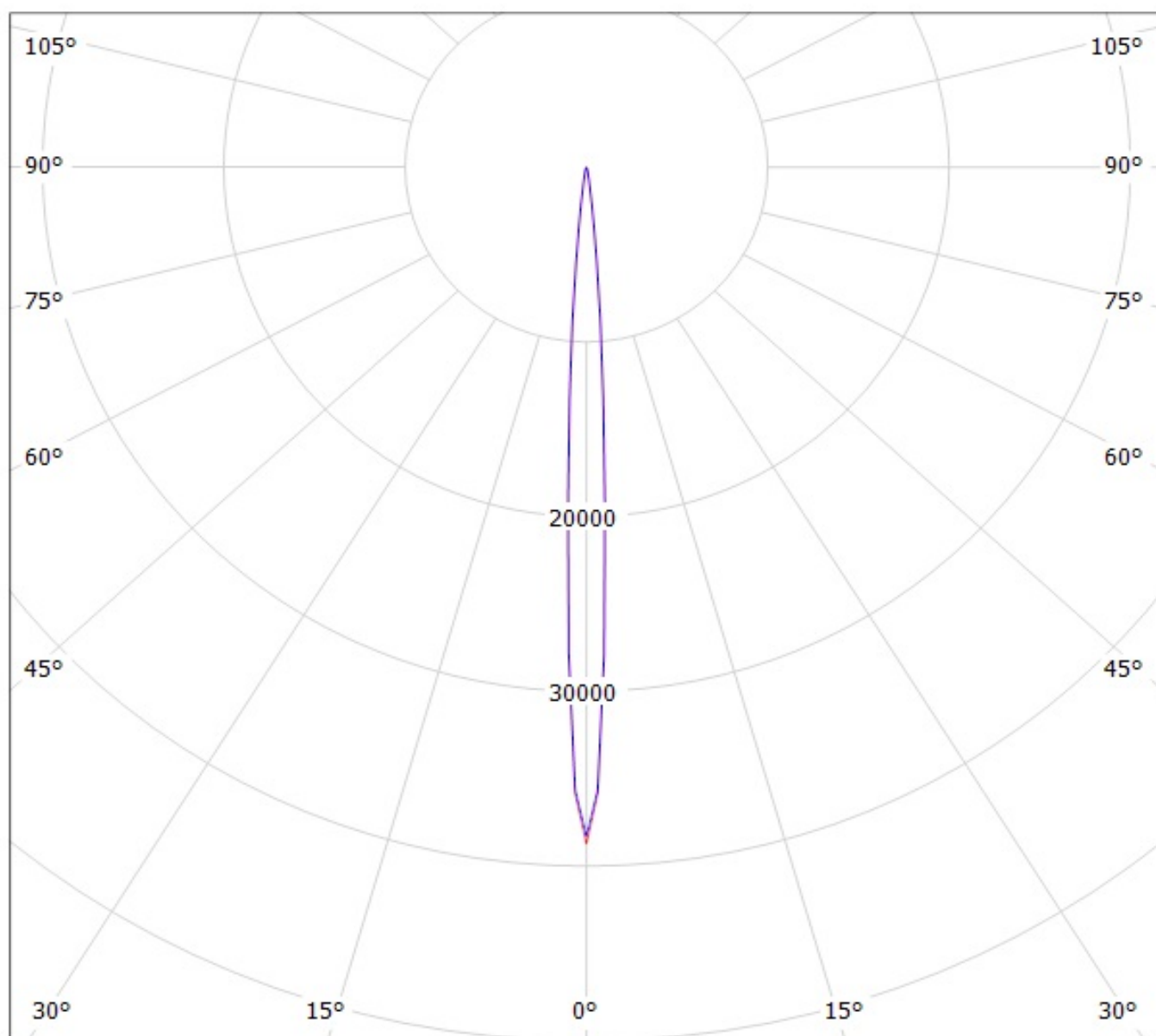

cd/klm

— C0 - C180 — C90 - C270

Luminaire: Ledil FCN12076_IRIS-SCREW_(NVSW319AE)

Lamps: 1 x Nichia_NVSW319AE_126.092lm@250mA_P=0.73005W_I=0.25A

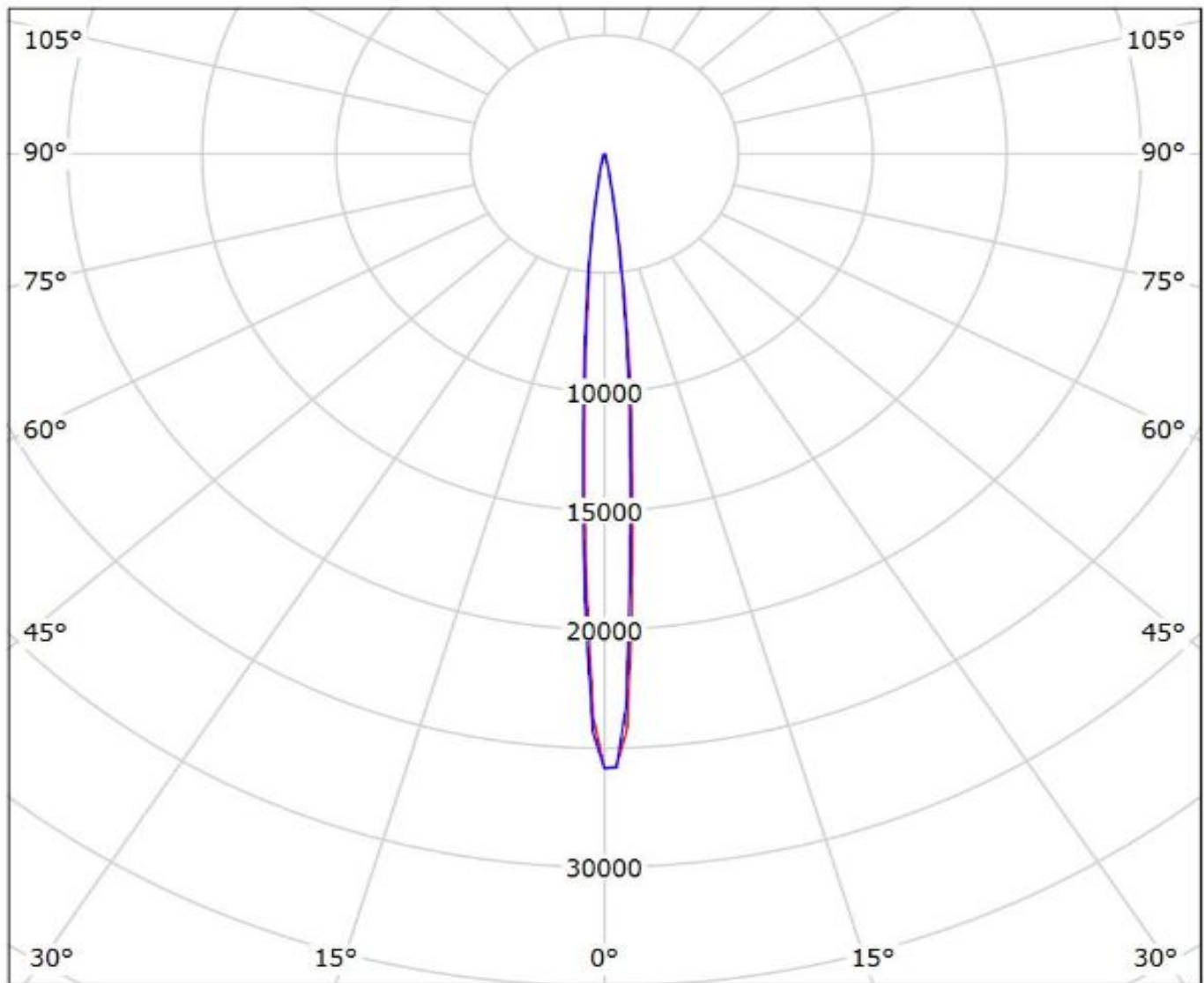

cd/klm

— C0 - C180

— C90 - C270

$\eta = 90\%$

Luminaire: Ledil Oy C4F12077_Iris-OSL150 C4F12077_Iris-OSL150
Lamps: 1 x Osram Oslon 150 deg 72lm

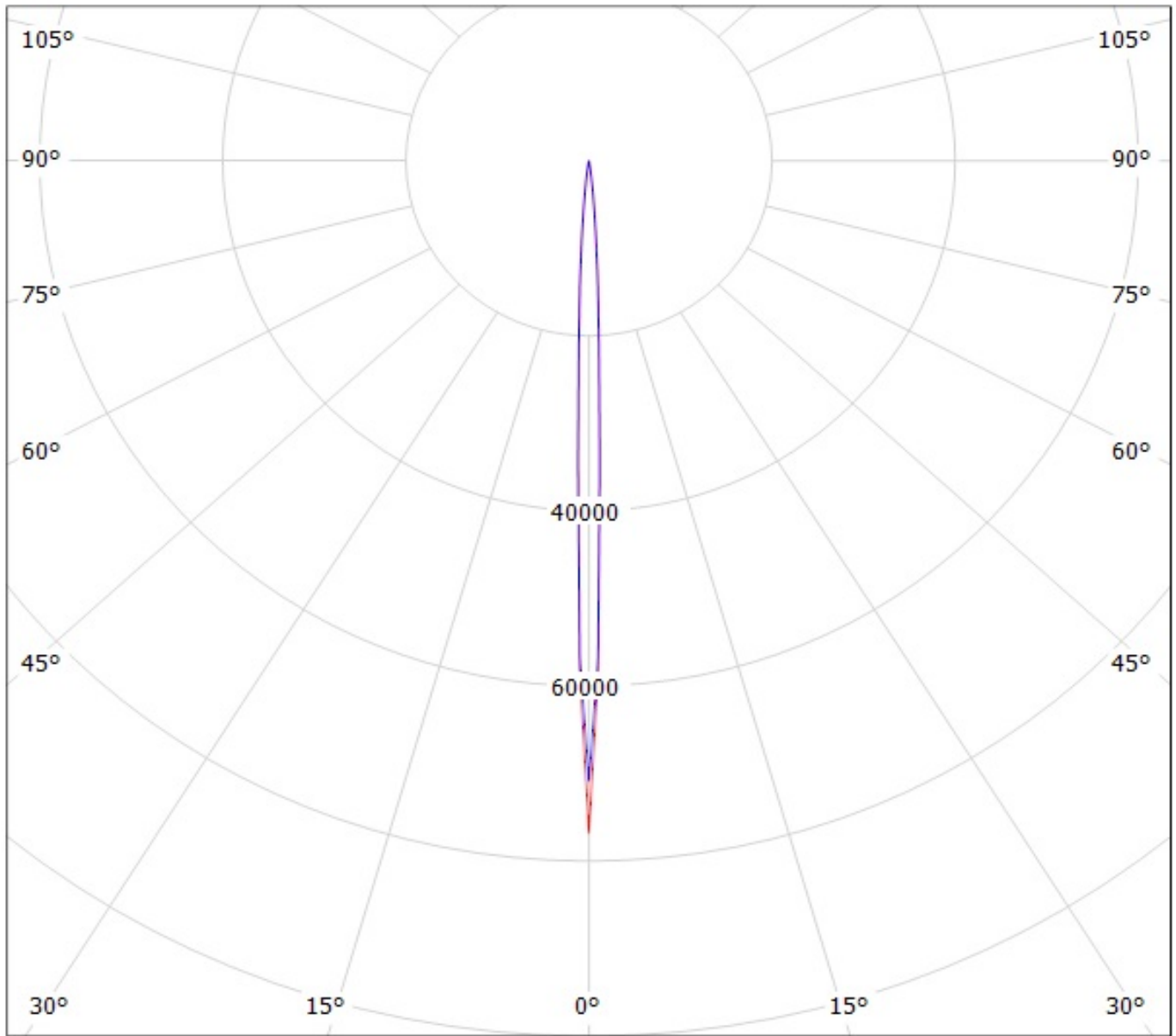

cd/klm

— C0 - C180

— C90 - C270

NOTE: The typical divergence will be changed by different color, chip size and chip position tolerance. The typical total divergence is the full angle measured where the luminous intensity is half of the peak value.