



Close-up of CAB.V11

CAB.V11

Specification

Part No.	CAB.V11
Product Name	CAB.V11 Taoglas Cable Assembly NMO Direct Mount - 3/4 inch Hole Brass Mount type to FME (F) Straight Jack with 3ft (915mm) RG-58U cable

1. Cable Insertion Loss

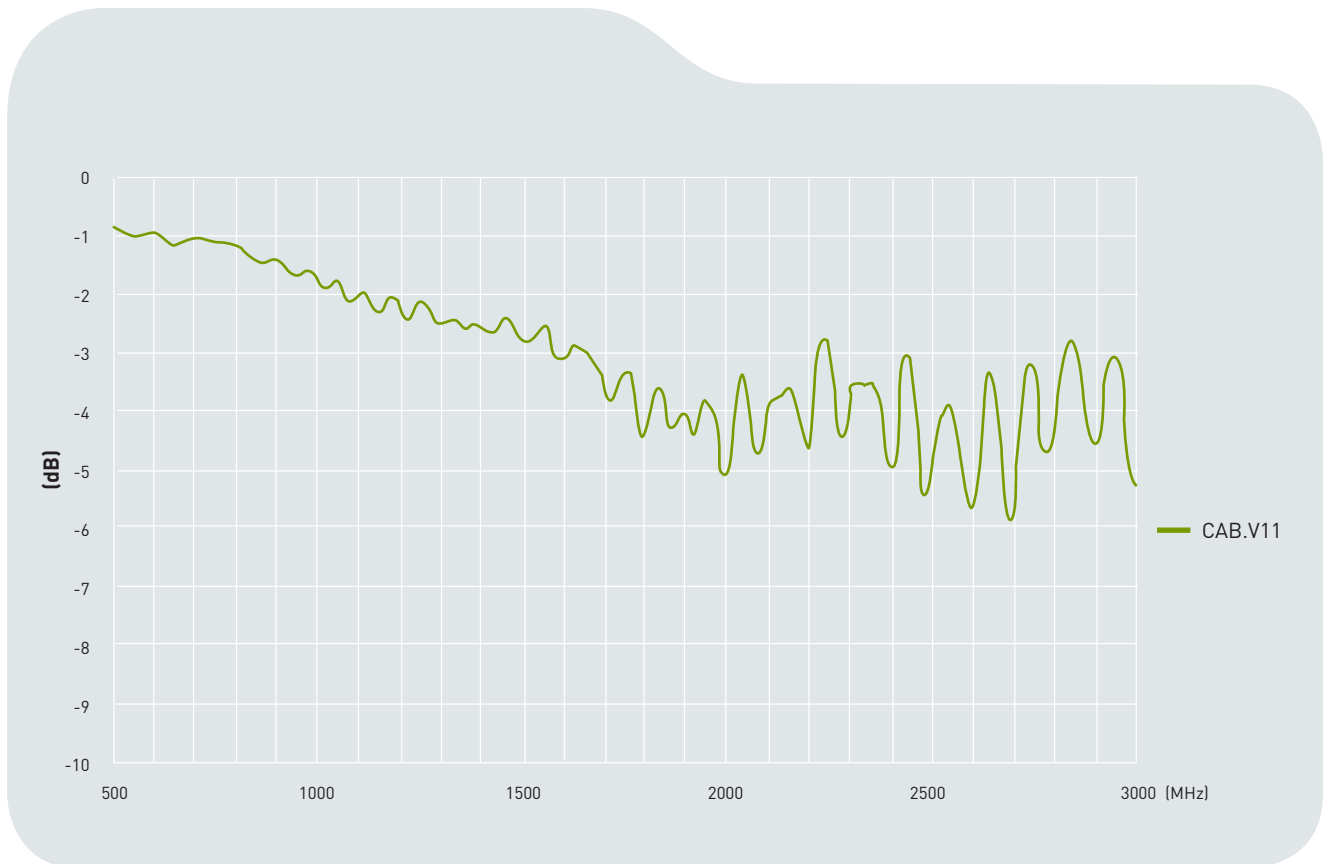

2. RG-58 Cable Specification

2.1 Drawing - Cross Section

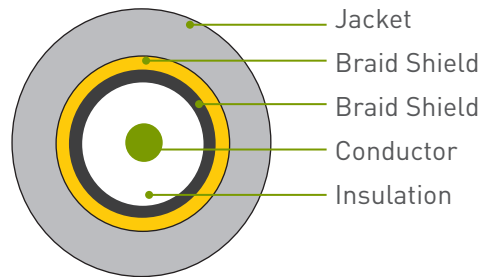

2.2 Structure and Dimensions

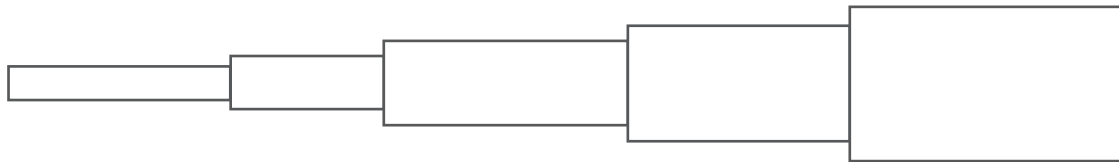

Conductor	Insulation	Braid Shield	Braid Shield	Jacket
<ul style="list-style-type: none"> Material - Bare Copper Wire Composition (1/1.02mm) Diameter - 1.02mm 	<ul style="list-style-type: none"> Material - Foam Polyethylene Avg. Thickness - 0.95mm Diameter - 2.9 ± 0.1mm 	<ul style="list-style-type: none"> Material - Aluminium Foil Construction - 0.020mm 	<ul style="list-style-type: none"> Material - Tinned - Copper Wire Structure - 16/6/0.12mm Coverage - 87% Diameter - 3.4 ± 0.05mm 	<ul style="list-style-type: none"> Material - RoHS PVC Diameter - 5.0 ± 0.15mm Colour - Black

2.3 Electrical & Physical Specification

Specification

Insulation Resistance:	1000 MΩ-Km (Min)				
Capacitance	83 ± 3 pF/m				
Nom. Impedance	53 ± 3 Ω				
Attenuation (dB/100ft)	200MHz	400MHz	700MHz	900MHz	1000MHz
	4.66	6.32	8.45	9.67	10.2

3. Technical Drawing

3.1 CAB.V11

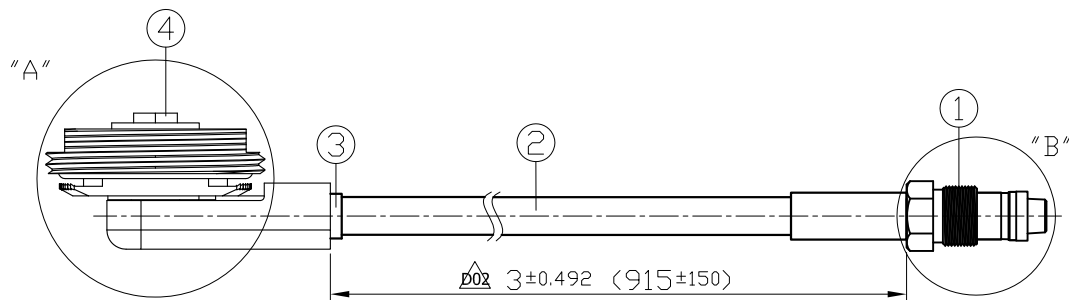

	Name	Material	Finish	QTY
1	FME(F) ST	Brass	Ni Plated	1
2	RG58 Coaxial Cable	PVC	Black	1
3	Heat Shrink Tube	PE	Black	1
4	NMO(DM)	Brass	Gold	1

3.2 Connectors

