

# AS series

## Snap-in rocker switches

*Distinctive features and specifications*



- Double insulation
- Epoxy sealed terminals
- UL and CSA approved

### ELECTRICAL AND GENERAL SPECIFICATIONS

- Max. current/voltage rating with resistive load :
  - silver contacts (code 1) and gold plated silver contacts (code 2) : 4A 30VDC
  - gold plated brass contacts (code 0) : 0,4VA 20V AC or DC
- Initial contact resistance : 10 mΩ max.
- Insulation resistance : 10.000 MΩ min.
- Dielectric strength :
  - 1.000 Vrms 50 Hz min. between terminals
  - 4.000 Vrms 50 Hz min. between terminals and metal panel
- Electrical life : 50.000 cycles
- Panel thickness : 1 (.039) to 3 mm (.118) max.
- Operating temperature : -40°C to +85°C

### MATERIALS

- Case : PES
- Actuator : polyamide
- Contacts
  - 0 : brass, gold plated
  - 1 : silver
  - 2 : silver, gold plated
  - 5 : special contact, lower rating
- Minimum quantity : consult factory.
- Terminal seal : epoxy

### APPROVALS



2A 250VAC  
4A 125VAC

**Availability** : consult factory for details or approved models.

**Marking** : to order switches marked with above approvals, complete last box of ordering format.

### ABOUT THIS SERIES

**Dimensions** : first dimensions are in mm while inches are shown as bracketed numbers.



**Packaging unit** : 50 pieces.

# AS series

## Snap-in rocker switches

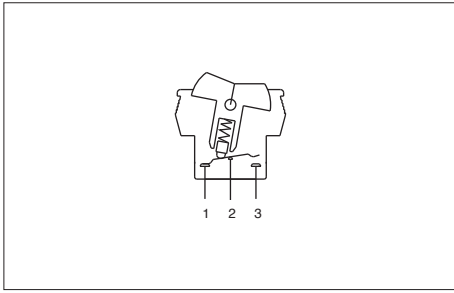

- Black body
- Single pole configuration

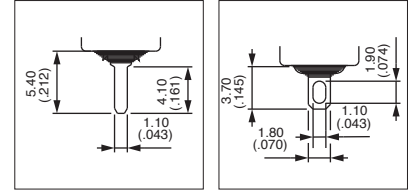

MODEL  
STRUCTURE

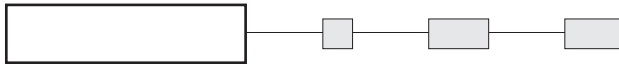

### Solder lug terminals



AS36S0  
AS39S0  
AS37S0  
AS38S0  
AS32S0

III	II	I
ON	-	ON
ON	OFF	ON
MOM	OFF	MOM
ON	OFF	MOM
ON	-	MOM

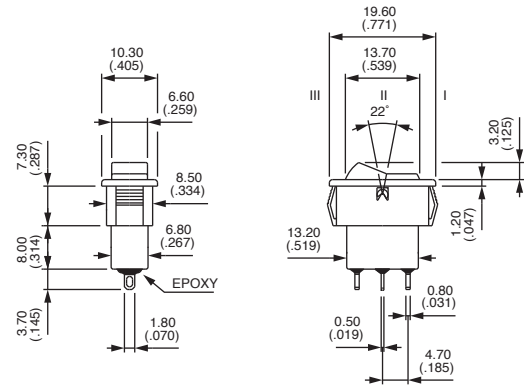

### Straight PC terminals



AS36P0  
AS39P0  
AS37P0  
AS38P0  
AS32P0

III	II	I
ON	-	ON
ON	OFF	ON
MOM	OFF	MOM
ON	OFF	MOM
ON	-	MOM

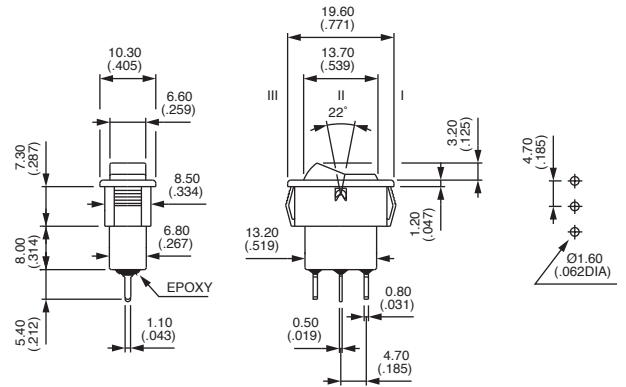

### PANEL CUT-OUT

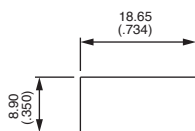



# AS series

Snap-in rocker switches

## CONTACT MATERIALS

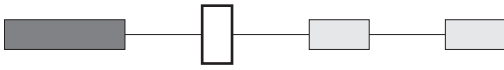

- 0 Brass, gold plated
- 1 Silver
- 2 Silver, gold plated
- 5 Special contact, lower rating  
Minimum quantity. Consult factory

## ACTUATORS

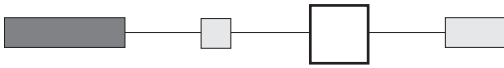

- 00 Black
- 01 Red
- 02 Grey
- 03 Blue
- 04 Ivory
- 07 White
- 09 Dark blue

For marking on actuator, consult factory.

## OTHER OPTIONS

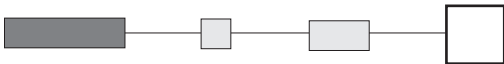

- 10 With **UL-CSA** marking
- 20 10 mm (.393) long straight PC terminals

