

10x10mm Compact Rotary DIP Switch

Features

Optimized Mechanical Features

- Standard through hole and surface mount gull-wing terminal configurations
- Binary Coded Decimal and Hexadecimal Output
- Clockwise or counterclockwise rotation
- Washable

Optimized Contact System

- Robust wiping contact
- Precise detents
- Gold plated beryllium copper contacts

Materials

- Tin coated terminals for better solderability
- High temperature materials (UL94V-0)
- RoHS compliant

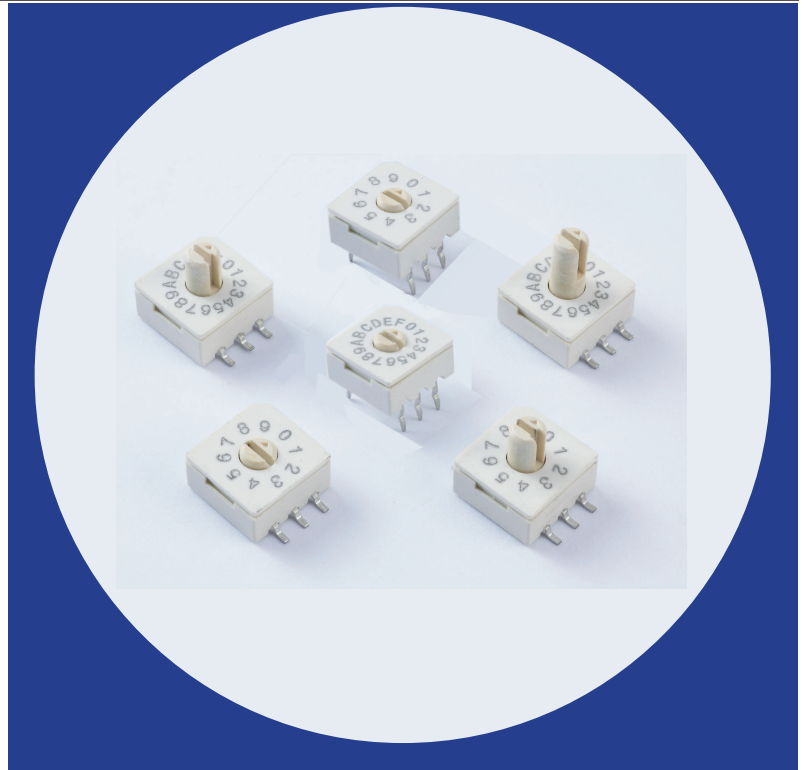

Electrical and Mechanical Specifications

Switch Options

10,16 positions

Output Code

Binary Coded Decimal
Hexadecimal

Switch Contact Resistance

80 milliohms maximum

Insulation Resistance

1000 Megohms minimum between insulated terminals

Dielectric Strength

350 VAC for 1 minute between adjacent terminals

Maximum Rating

100 mA, 50 VDC

Minimum Load

1 μ A 20 mV

Operating Temperature

- 40°C to +85°C

Rotational Torque

144~432 gf-cm

Actuation Life

20,000 steps

Allowable Solder Time

Reflow soldering up to 10 seconds at 260°C max.
Wave soldering up to 10 seconds at 260°C max.
Manual soldering up to 5 seconds at 350°C max.

Packaging

Through Hole Switch : Anti-static tube packaging
Surface Mount Switch : Tape and reel packaging

CTS SERIES 221AM - Surface Mount Gull Wing

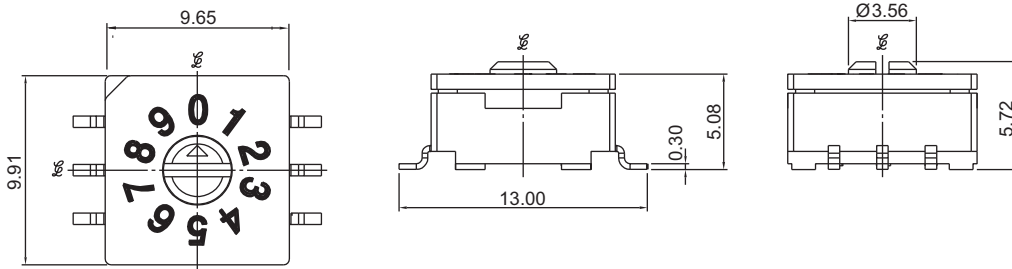

PCB LAYOUT

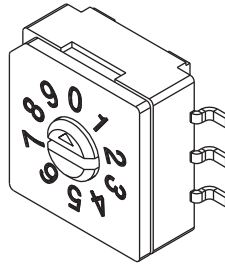
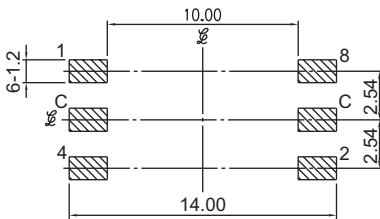

DIMENSION : mm
STANDARD TOLERANCE :
.XX (2 PLACE) : ±0.30

CODE TABLE

POSITIONS	CODE			
	1	2	4	8
0				
1	●			
2		●		
3	●	●		
4			●	
5	●		●	
6		●	●	
7	●	●	●	
8				●
9	●			
A		●	●	●
B	●	●		
C			●	●
D	●		●	●
E		●	●	●
F	●	●	●	●

Dot indicates terminal to common connection. All switches are continuous rotation.
10 Position - Numbered 0 through 9
16 Position - Numbered 0 through F

CTS SERIES 221AD - Standard Through Hole

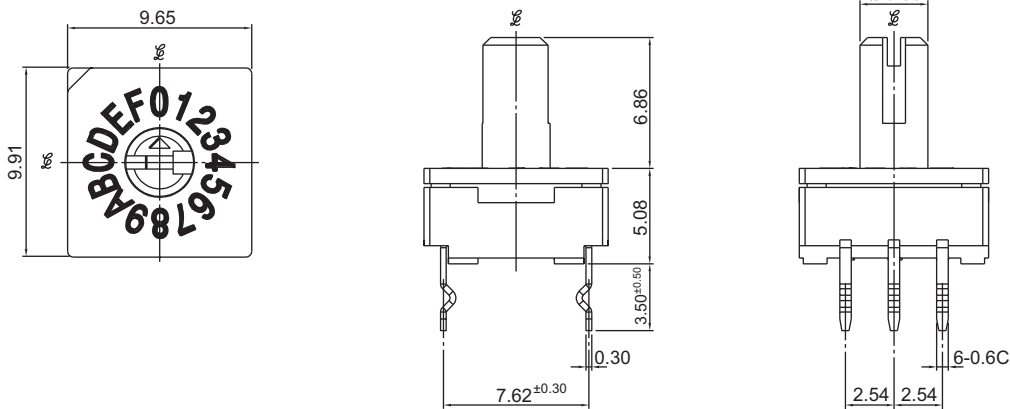

PCB LAYOUT

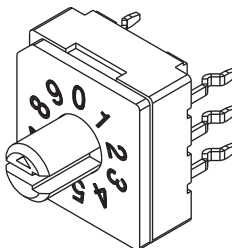
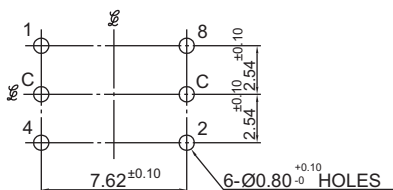

DIMENSION : mm
STANDARD TOLERANCE :
.XX (2 PLACE) : ±0.30

CODE TABLE

POSITIONS	CODE			
	1	2	4	8
0				
1	●			
2		●		
3	●	●		
4			●	
5	●		●	
6		●	●	
7	●	●	●	
8				●
9	●			
A		●	●	●
B	●	●		
C			●	●
D	●		●	●
E		●	●	●
F	●	●	●	●

Dot indicates terminal to common connection. All switches are continuous rotation.
10 Position - Numbered 0 through 9
16 Position - Numbered 0 through F

Actuator Options



A: FLUSH ARROW & SLOTTED ROTOR

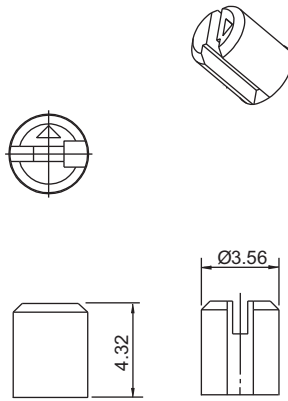

B: ARROW & SLOTTED SHAFT

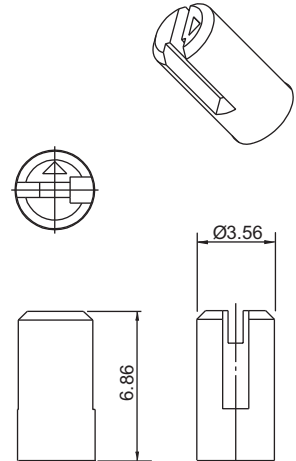

C: ARROW & SLOTTED SHAFT

DIMENSION : mm
STANDARD TOLERANCE :
.XX (2 PLACE) : ±0.30

Ordering Information

